

**COBHAM**

# SAILOR 6222 VHF DSC

User manual





# **SAILOR 6222 VHF DSC**

## User manual

**Document number:** 98-131184-J

**Release date:** July 5, 2017

## Disclaimer

Any responsibility or liability for loss or damage in connection with the use of this product and the accompanying documentation is disclaimed by Thrane & Thrane A/S. The information in this manual is provided for information purposes only, is subject to change without notice and may contain errors or inaccuracies. Manuals issued by Thrane & Thrane A/S are periodically revised and updated. Anyone relying on this information should acquire the most current version e.g. from [www.cobham.com/satcom](http://www.cobham.com/satcom), **Cobham SYNC Partner Portal**, or from the distributor. Thrane & Thrane A/S is not responsible for the content or accuracy of any translations or reproductions, in whole or in part, of this manual from any other source. In the event of any discrepancies, the English version shall be the governing text.

Thrane & Thrane A/S is trading as Cobham SATCOM.

## Manufacturer

Thrane & Thrane A/S, Lundtoftegårdsvej 93D, DK-2800 Kgs. Lyngby, Denmark.  
Industrivej 30, DK-9490 Pandrup, Denmark.

## Copyright

© 2017 Thrane & Thrane A/S. All rights reserved.

## Trademark Acknowledgements

- **Thrane & Thrane** is a registered trademark of Thrane & Thrane A/S in the European Union and the United States.
- **SAILOR** is a registered trademarks of Thrane & Thrane A/S.
- Other product and company names mentioned in this manual may be trademarks or trade names of their respective owners.

## **GPL notification**

The software included in this product contains copyrighted software that is licensed under the GPL/LGPL. The verbatim licenses can be found online at:

<http://www.gnu.org/licenses/old-licenses/gpl-2.0.html>

<http://www.gnu.org/licenses/old-licenses/lgpl-2.1.html>

You may obtain the complete corresponding source code from us for a period of three years after our last shipment of this product, which will be no earlier than December 31, 2015, by sending a money order or check for DKK 50 to:

SW Technology/GPL Compliance,  
Cobham SATCOM (Thrane & Thrane A/S),  
Lundtoftegaardsvej 93D  
2800 Lyngby  
DENMARK

Write "source for product SAILOR 6222 VHF DSC" in the memo line of your payment. This offer is valid to anyone in receipt of this information.

[http://www.cobham.com/about-cobham/communications-and-connectivity/about-us/satcom/free-and-open-source-software-\(foss\).aspx](http://www.cobham.com/about-cobham/communications-and-connectivity/about-us/satcom/free-and-open-source-software-(foss).aspx)

## **Warranties**

Any attempt to install or execute software not supplied by Cobham SATCOM on this device will result in the warranty being void. Any attempt to modify the software on this device in a way not specified by Cobham SATCOM will result in the warranty being void.

## **Safety warning**

The following general safety precautions must be observed during all phases of operation, service and repair of this equipment. Failure to comply with these precautions or with specific warnings elsewhere in this manual violates safety standards of design, manufacture and intended use of the equipment. Thrane & Thrane assumes no liability for the customer's failure to comply with these requirements.

### **Ground the equipment**

To minimise shock hazard, the SAILOR 6222 VHF DSC unit must be connected to an electrical ground and the cable instructions must be followed.

### **RF exposure hazards and instructions**

Your Thrane & Thrane radio set generates electromagnetic RF (radio frequency) energy when transmitting. To ensure that you and those around you are not exposed to excessive amounts of energy and thus to avoid health hazards from excessive exposure to RF energy, all persons must be at least 200 cm away from the antenna when the radio is transmitting.

### **Warranty limitation**

IMPORTANT - The radio is a sealed waterproof unit (classified IPX8). To create and maintain its waterproof integrity it was assembled in a controlled environment using special equipment. The radio is not a user maintainable unit, and under no circumstances should the unit be opened except by authorized personnel. Unauthorized opening of the unit will invalidate the warranty.

### **Installation and service**

Installation and general service must be done by skilled service personnel.

### **Compass safe distance**

Minimum safety distance: 0.85 m from the SAILOR 6222 VHF DSC.

## **Alerte de sécurité**

### **Dangers liés à l'exposition aux fréquences radio et instructions**

Conformément à la réglementation d'Industrie Canada, le présent radio émetteur ne peut fonctionner qu'avec une antenne de type omnidirectionnelle, demi-onde ou d'un gain maximal de 4 dB, approuvée par Industrie Canada. Pour éviter les risques pour la santé dus à une exposition excessive aux champs de fréquences radio, une distance minimale de 200 cm est nécessaire entre l'utilisateur et le radio-émetteur.

## Emergency calls



Lift Cover

Press **RED Button**

until beep sounds continuously  
(more than 3 seconds)

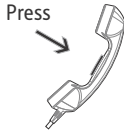

Use the **HANDSET** for voice calling

**MAYDAY-MAYDAY-MAYDAY**

This is

**NAME-NAME-NAME**

**CALLSIGN**

or other **IDENTIFICATION**

**MMSI**

(If the initial alert is sent by DSC)

**OWN ID**

SHIP's NAME: \_ \_ \_ \_ \_

CALLSIGN: \_ \_ \_ \_ \_

MMSI: \_ \_ \_ \_ \_



**MAYDAY**

**NAME** of the **VESSEL** in distress

**CALLSIGN** or other **IDENTIFICATION**

**MMSI**

(If the initial alert is sent by DSC)

**POSITION**

given as **latitude** and **longitude**

or

If latitude and longitude are not known

or if time is insufficient,

in relation to a known geographical location

**NATURE** of distress

Kind of **ASSISTANCE** required

Any other useful **INFORMATION**

### DISTRESS and COMMUNICATION FREQUENCIES

	DSC	Radiotelephony	NBDP
VHF	Channel 70	Channel 16	-----
MF	2187.5 kHz	2182.0 kHz	2174.5 kHz
HF4	4207.5 kHz	4125.0 kHz	4177.5 kHz
HF6	6312.0 kHz	6215.0 kHz	6268.0 kHz
HF8	8414.5 kHz	8291.0 kHz	8376.5 kHz
HF12	12577.0 kHz	12290.0 kHz	12520.0 kHz
HF16	16804.5 kHz	16420.0 kHz	16695.0 kHz

Remember to use the correct HF-procedures  
Don't forget your EPIRB is the secondary means of alerting

99-13240



---

# Preface

## Radio for occupational use

The SAILOR 6222 VHF DSC fulfils the requirements of SOLAS and is intended for use in maritime environment.

SAILOR 6222 VHF DSC is designed for *occupational use only* and must be operated by licensed personnel only.

SAILOR 6222 VHF DSC is not intended for use in an uncontrolled environment by general public.

SAILOR 6222 VHF DSC is designed for installation by a skilled service person.

---

## Training information

The SAILOR 6222 VHF DSC is designed for *occupational use only* and is also classified as such. It must be operated by licensed personnel only. It must only be used in the course of employment by individuals aware of both the hazards as well as the way to minimize those hazards

The radio is thus NOT intended for use in an uncontrolled environment by general public. The SAILOR 6222 VHF DSC has been tested and complies with the FCC RF exposure limits for *Occupational Use Only*. The radio also complies with the following guidelines and standards regarding RF energy and electromagnetic energy levels including the recommended levels for human exposure:

- FCC OET Bulletin 65 Supplement C, evaluating compliance with FCC guidelines for human exposure to radio frequency electromagnetic fields.
- American National Standards Institute (C95.1) IEEE standard for safety levels with respect to human exposure to radio frequency electromagnetic fields, 3 kHz to 300 GHz
- American National Standards Institute (C95.3) IEEE recommended practice for the measurement of potentially hazardous electromagnetic fields - RF and microwaves.

Below the RF exposure hazards and instructions in safe operation of the radio within the FCC RF exposure limits established for it are described.

## Warning

Your Thrane & Thrane radio set generates electromagnetic RF (radio frequency) energy when it is transmitting. To ensure that you and those around you are not exposed to excessive amounts of that energy (beyond FCC allowable limits for occupational use) and thus to avoid health hazards from excessive exposure to RF energy, FCC OET bulletin 65 establishes an Maximum Permissible Exposure (MPE) radius of 200 cm for the maximum power of your radio (25W selected) with an half wave omni-directional antenna having a maximum gain of 4 dB. This means all persons must be at least 200 cm away from the antenna when the radio is transmitting.

---

## Installation

1. An omni-directional antenna with a maximum power gain of 4 dB must be mounted at least 400 cm above the highest deck where people may be staying during radio transmissions. The distance is to be measured vertically from the lowest point of the antenna. This provides the minimum separation distance which is in compliance with RF exposure requirements and is based on the MPE radius of 200 cm plus the 200 cm height of an adult.
2. On vessels that cannot fulfil requirements in item 1, the antenna must be mounted so that its lowest point is at least 3 ft. (0.9m) vertically above the heads of people on deck and all persons must be outside the 200 cm MPE radius during radio transmission.
  - Always mount the antenna at least 200 cm from possible human access.
  - Never touch the antenna when transmitting
  - Use only authorized T&T accessories.
3. If the antenna has to be placed in public areas or near people with no awareness of the radio transmission, the antenna must be placed at a distance not less than 200 cm from possible human access.

Failure to observe any of these warnings may cause you or other people to exceed FCC RF exposure limits or create other dangerous conditions.

---

## Manual overview

This manual has the following chapters and appendices:

- *Introduction* contains a description of the VHF radio.
- *Operation* explains how to make and receive voice and DSC calls over VHF, including how to use and set-up scanning, watch and replay.
- *Service & maintenance* contains support information including lists of accessories and a troubleshooting guide.
- Appendix with *Specifications* and *Maritime channels*.

### Important

**All installation information and instructions are not covered in this manual.** Please download the **SAILOR 6222 VHF DSC Installation manual** at

<http://sync.cobham.com/satcom/products/marine>.

In the installation manual you can read how to mount the VHF radio and how to connect accessories and external equipment, including detailed system configuration examples with cable specifications.

## Related documents

Title and description	Document number
<b>SAILOR 6222 VHF DSC</b> , Installation guide	98-132281
<b>SAILOR 6222 VHF DSC</b> , Installation manual (download only)	98-135548
<b>SAILOR 6101 and SAILOR 6103 Alarm Panel</b> , Installation and user manual	98-130981
Emergency call sheet	98-132369

# Table of Contents

---

## Chapter 1 Introduction

VHF radio with DSC Class A .....	1
Accessories available .....	4

## Chapter 2 Operation

Overview .....	9
General use and navigation .....	10
VHF radio communication .....	15
Watch .....	19
Scan .....	20
DSC calls .....	21
Handling multiple calls — DSC and voice .....	34
Phone book .....	35
Replay function .....	38
Setup .....	38

## Chapter 3 Service & maintenance

Contact for support .....	51
Maintenance .....	51
Troubleshooting guide .....	53
Warranty and returning units for repair .....	61

## App. A Specifications

Transceiver unit SAILOR 6222 VHF DSC .....	63
General DSC specifications .....	65

	NMEA data rates and formats .....	66
	SAILOR 6090 Power Converter 24—12 V .....	66
<b>App. B</b>	<b>Maritime channels</b>	
	International channels (INT) .....	67
	US channels .....	68
	CA channels .....	69
	BI channels .....	70
<b>Glossary</b>	.....	73
<b>Index</b>	.....	77

# Introduction

## VHF radio with DSC Class A

SAILOR 6222 VHF DSC your new VHF radio with full DSC functionality, is approved to MED, FCC and Industry Canada and is waterproof to the IPx8 and IPx6 standard. As part of the required safety equipment, use the SAILOR 6222 VHF DSC in an emergency situation.

However the best way to guarantee functionality in an emergency situation, is to use the radio in daily communication on board.



The VHF radio is a simplex/semi duplex VHF radio. It is designed with an easy-to-use menu-driven setup. You use the soft keys and the keypad to enter the desired functions, you browse and select a setting using the right selection knob. The large display can be customized for optimum readability and visibility both day and night with several color themes.

The VHF radio can replay the last 240 s of received voice messages. This is a useful feature to minimize misunderstandings and to record messages when the radio is unattended.

With SAILOR connection boxes the VHF radio connects easily to external equipment like additional handsets, water proof hand microphones, control speaker microphone, alarm panel or external speaker. The Ethernet interface enables the VHF radio to be connected to ThraneLINK for service updates.

For a list of accessories available for the VHF radio see *Accessories available* on page 4 and check with your nearest distributor.

## Controls on the front plate



Figure 1: Controls on the front plate

1. Loudspeaker.
2. Four soft keys with function title in the display.
3. Large display.
4. Keys 0 to 9 to enter numbers or text.
5. **DW** button to toggle the watch function (dual or triple).
6. **16/C** quick selection key for channel 16 and the programmed call channel.
7. Connector for Handset or Handmicrophone. If not used, put the cap from the ACC connector on the front connector to prevent water ingress.
8. Distress button for sending a Distress alert.
9. Squelch control to mute background noise.
10. Volume knob with key-press function for volume control and power on/off.
11. Selector and dim knob with key-press function for general operation, display color selection and dimming.
12. **1W** button to toggle between high and low power.
13. Replay button to play back up to 240 s voice message.



## SAILOR 6222 VHF DSC display

The picture shows the display after start-up. The display holds various fields of information, depending on the currently selected function.

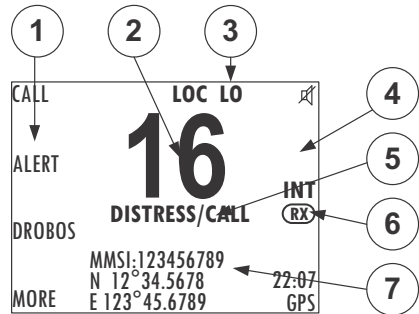

1. Functions you can select with the soft keys. If there are more than 4 functions in the list press the soft key **MORE** to display further functions.
2. Current working channel.
3. **System property icons** with information relevant for the currently selected functions.
4. Channel properties next to the currently selected VHF channel (if any).
5. **Service line** containing current temporary information relevant for the current channel or function.
6. Current state: RX or TX.
7. **DSC window** with DSC information (MMSI number, position information and UTC time of position and origin), or specific information relevant to other functions, e.g. Replay, etc.).





For a detailed description of the information shown for each of the functions available see the chapter *Operation* on page 9.

## Accessories available

Accessory	Description
<p>SAILOR 6201 Handset with cradle (additional)</p>	<p>One SAILOR 6201 Handset with cradle is included in the delivery of the SAILOR 6222 VHF DSC. You can connect another SAILOR 6201 Handset with cradle.</p> 
<p>SAILOR 6203 Handset with cradle</p>	<p>SAILOR 6203 Handset with cradle, waterproof to IPx6.</p> 
<p>SAILOR 6202 Hand Microphone</p>	<p>You can use the SAILOR 6202 Hand Microphone (waterproof to IPx6 and IPx8) instead of the handset.</p> 
<p>SAILOR 6204 Control Speaker Microphone</p>	<p>With the SAILOR 6204 Control Speaker Microphone you can control the VHF voice functions of the SAILOR 6222 VHF DSC.</p> 
<p>SAILOR 6207 Connection Box for parallel Handsets</p>	<p>The SAILOR 6207 Connection Box for parallel Handsets including Connection Cable 406209-941 is used for easy installation of several SAILOR 6201/SAILOR 6203 Handsets.</p> 

Accessory	Description
SAILOR 6208 Control Unit Connection Box	<p>SAILOR 6208 Control Unit Connection Box including Connection Cable 406208-941 is used for easy installation of external equipment and accessories:</p> <ul style="list-style-type: none"> <li>• Max. 4 SAILOR 6204 Control Speaker Microphones</li> <li>• VDR</li> <li>• SAILOR 6270 External Loudspeaker</li> <li>• Alarm panels and GPS input</li> </ul> 
Connection cables	<p><b>5m connection cable for bulkhead mount:</b> Use this cable in installations where the SAILOR 6201 Handset with cradle or SAILOR 6203 Handset with cradle is not connected directly to the SAILOR 6222 VHF DSC, but located in a different position (part number: 406204-940).</p> <p><b>5m Connection cable, 1x10 pole:</b> Use this cable in installations when connecting external equipment to the SAILOR 6222 VHF DSC. This cable is included in the SAILOR 6207 Connection Box for parallel Handsets (part number: 406207-941).</p> <p><b>5 m Connection cable for SAILOR 6204 Control Speaker Microphone, 1x12 pole</b> (part number: 406204-940).</p>
SAILOR 6270 External Loudspeaker	<p>If you need an additional external loudspeaker you can connect a SAILOR 6270 External Loudspeaker. It provides 6 W output power.</p> 
SAILOR 6103 Multi Alarm Panel	<p>With the SAILOR 6103 Multi Alarm Panel you can activate GMDSS Distress Alarms. The Multi Alarm Panel can be connected to the SAILOR 6222 VHF DSC via the Ethernet interface (LAN connector, ThraneLINK).</p> 

<b>Accessory</b>	<b>Description</b>
SAILOR 6197 Ethernet Switch	The SAILOR 6197 Ethernet Switch is used in installations with SAILOR 6103 Multi Alarm Panels and in installations with ThraneLINK. The Ethernet switch has 5 ports. 
SAILOR 6090 Power Converter 24 V to 12 V DC	The SAILOR 6090 Power Converter is used to provide 12 V DC for the SAILOR 6222 VHF DSC from a 24 V DC power source. 

## System configuration — example

The SAILOR 6222 VHF DSC can be customized to suit your installation. The following illustration is one example of a system. For further configuration examples see the installation manual, Appendix B, *System configurations*.

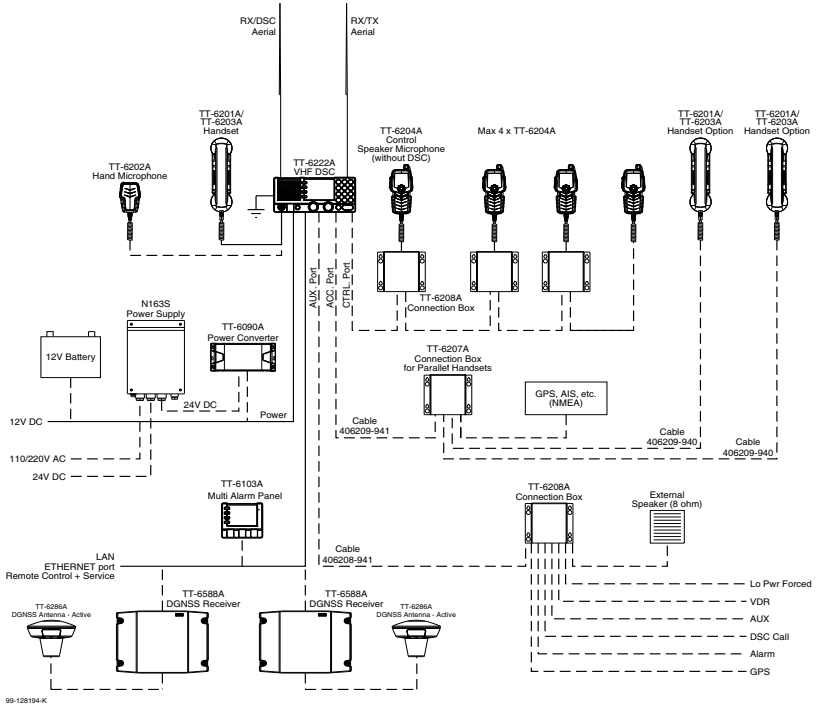

Figure 2: System configuration, example



# Operation

**Note**

Before using the VHF radio make sure that the VHF and DSC antennas, power cable and other external equipment are connected properly. For installation instructions see the *SAILOR 6222 VHF DSC, Installation manual (download only)*.

## Overview

In this chapter you find detailed instructions and guidelines for:

- *General use and navigation*
- *VHF radio communication*
- *Watch*
- *Scan*
- *DSC calls*
- *Handling multiple calls — DSC and voice*
- *Phone book*
- *Replay function*
- *Setup*

## General use and navigation

### Power on and volume in handset and speaker

The VHF radio has a dual-function on/off knob for power on/off and volume control.

To power on the VHF radio press the on/off knob.

To power off the VHF radio, press and hold the on/off knob and follow the instructions in the display.

To adjust the speaker volume, turn the volume knob (clockwise = louder, counter clockwise = softer, until muted). When muted,  is shown in the display.

To adjust the volume of the handset earpiece see *Radio setup* on page 39.



### Working channel and changing settings

Use the **selector knob** to browse and select:

- To browse and select **settings**, turn the selector knob and press for accept.
- To select a **working channel** use the selector knob or enter the channel number using the keypad. You can change channels whenever the channel designator is displayed.

**Note**

A single, short press on the **16/C** key always brings you to **channel 16**, the international calling and distress channel, no matter what state the radio is in.





## Speaker devices

The VHF radio can be equipped with the following speaker devices:

- SAILOR 6201/SAILOR 6203 Handset with cradle and PTT (Push To Talk) button.
- SAILOR 6202 Hand Microphone with PTT button.
- SAILOR 6204 Control Speaker Microphone with PTT button.

See *Controller setup* on page 47 for controlling the connected speaker devices.

## DSC and MMSI number

The MMSI is a unique, 9-digit identifier assigned to your ship. When the VHF radio is powered on for the first time, the vessel's MMSI number is programmed in the radio. This is typically done during installation of the radio and described in the installation manual.

**Important**

The MMSI number must be programmed into the VHF radio to use any DSC functionality. The radio will prompt for the MMSI number at each power-up until the MMSI has been entered. You can use the radio in normal VHF mode.



**Caution!** Without a programmed MMSI number the Distress button will not work!

## Position and MMSI number

The position and MMSI number for the SAILOR 6222 VHF DSC radio is always shown in the DSC window (the lower half of the radio's display) in stand-by mode. The display shows also the current (latest) position (if a GPS is connected), the UTC and position type and GPS Status.

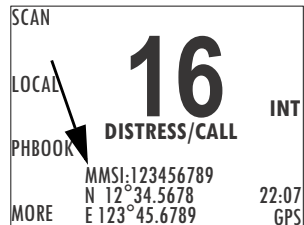

### Enter position manually (no GPS)

If you need to enter the vessel's position and UTC of position manually, do as follows:

1. Press the soft key **SETUP**. If it is not in the display, press the soft key **MORE** until **SETUP** appears.
2. Press the arrow soft key **▶** or **◀** to advance to **DSC SETUP**.
3. Press the selector knob to select **Position & MMSI**.
4. Enter the current position and UTC time:
  - Latitude (LAT),
  - Longitude (LON)
  - UTC time (POS UTC)

Turn and press the selector knob to select the value you want to change. Then use the keypad or press and turn the selector knob to enter the current values for position and UTC time. You can clear all position data by pressing **CLEAR**.

5. Having entered the UTC time, the soft key **SAVE** appears. Press **SAVE** and then **EXIT** to return to normal operation. The display shows **Man** in the lower right corner.
6. After you have entered a value manually or overruled the GPS input, a soft key **UseGPS** appears in the display if the GPS is available. Press this soft key if you decide to use the data from the connected GPS.

If the GPS was present and then disappears a warning appears in the display after 10 minutes, then you can enter the position and UTC time manually as described above.

## Soft-key functions

A number of functions of the SAILOR 6222 VHF DSC are accessed and set using the four soft keys to the left of the display. The current function of a soft key is shown in the display next to the soft key.

The following soft-key functions are available from top-level standby:

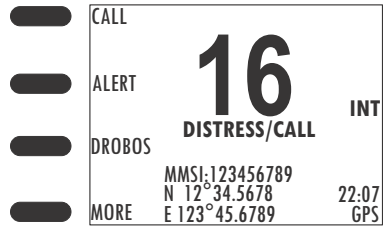

Soft key	Function
CALL	To make DSC non-distress calls
ALERT	To make a distress call with assigned category
DROBOS	Make a distress relay call on behalf of someone else
SCAN	Scanning menu with start, stop and tag function
PHBOOK	Phone book
LOCAL	Local mode, 10 dB attenuation
SETUP	Setup pages for <i>Radio setup</i> , <i>Channel setup</i> , <i>Power Supply</i> , <i>DSC SETUP</i> , <i>DSC CALL LOGS</i> , <i>System setup</i> and <i>Controller setup</i> .

Use the soft key **MORE** to display further soft key functions.

## Changing the display light, night view

Red text on black background is available for optimal night vision.

To **dim the display backlight**, e.g. to give comfortable night vision, press, hold and turn the selector knob anti-clockwise. The display shows a brightness bar. At the brightness value 45 the display changes to **night view** with red text on black background.

To return to day vision press, hold and turn the selector knob clockwise until the display changes and it reaches the desired brightness.

The radio has two colour themes: Black text on a white background (default) or white text on black background. To change the **color theme** see *System setup* on page 44.



*Alternative colour theme*

## Adjusting the squelch level

With the Squelch control you can manually adjust and suppress noise in order to optimize the quality of the received radio communication.



When hearing noise or an unwanted signal, turn the squelch button clockwise until the speaker is muted.

## Use with a SAILOR 6204 Control Speaker Microphone

When a SAILOR 6204 Control Speaker Microphone is connected to the radio, you can operate the radio with the Control Speaker Microphone. An occupied message is shown in the radio's display. At any time you can take control over the Control Speaker Microphone by pressing any key on the radio.

# VHF radio communication

## Basic VHF operation

You can make VHF calls using the Handset or another speaker device.

**Note** A single, short press on the **16/C** key always brings you to **channel 16**, the international calling and distress channel, no matter what state the radio is in.



## Quick guide to radio telephone calls

1. Press the **PTT** button on the speaker device. When the **TX** indicator lights up in the display, the transmission is active.
2. To enable reception of a radio signal release the **PTT** button.



**Note** Press **PTT** only when you are talking. Always say “Over.” just before releasing the PTT button.

One transmission is limited to **5 minutes** duration.

## Receiving a radio telephone call on channel 16

When you hear your call name in the loudspeaker, proceed as follows:

1. The symbol **RX** shows that the radio is receiving on the channel displayed.
2. Lift the Handset or take another speaker device.
3. Press the **PTT** button. The symbol **TX** shows that the radio is transmitting on the channel displayed.
4. Repeat the name of the station calling you and say: “This is [your ship’s name]”.
5. Suggest a working channel other than 16 by saying: “Channel [suggested channel number]”.
6. Say: “Over.” and release the **PTT** button to allow the caller to confirm the suggested new channel.

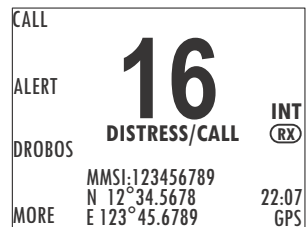

7. Switch to the new channel using the keypad or by turning the selector knob to the agreed channel and begin your conversation. Press **PTT** only when you are talking.

### Making a radio telephone call on channel 16

To make a radio telephone call, proceed as follows:

1. Select channel 16.
2. Lift the Handset or take another speaker device.
3. Press the **PTT** button. The symbol **TX** shows that the VHF radio is transmitting on the working channel displayed.
4. Say the name of the station you are calling three times.
5. Say: "This is [your ship's name]".
6. Say: "Over." and release the **PTT** button to listen. The symbol **RX** shows that the radio is receiving on the working channel displayed
7. When answered, agree upon a working channel other than 16.
8. Switch to the new channel by entering the channel number to the agreed channel and begin your conversation.

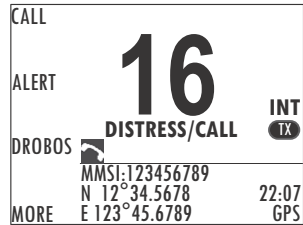

### VHF channels

You can change channels whenever the channel designator is displayed. Enter the channel using the keypad or turn the selector knob to browse through all channels that are available in the selected channel table. Only valid channel numbers are accepted. When browsing channels they appear in the display in the following order:

- Primary channels
- Weather channels (if any)
- Private channels (if any)

With a long press on the **16/C** key the radio changes to the call channel (channel 16 for the channel tables INT and BI, and channel 9 for the channel tables US and CA, if no other channel is programmed in *Channel setup* on page 41).



VHF channel table	Description
Primary channels (no prefix)	For details see <i>Maritime channels</i> on page 67. For instructions how to change a channel table see <i>Channel setup</i> on page 41.
Weather (WX)	Weather channels have the prefix <b>W</b> . (For US and CA channels only.)
Private (PRIV)	Up to 100 user-defined private channels.

For more information on how to setup channels setup see *Channel setup* on page 41. Contact your local dealer if you are interested in having private channels.

## Channel information always available in the display

For some functions and for setup pages, the channel and radio information has moved to the bottom section of the display. You can change channels whenever the channel designator is displayed.

The channel number displayed in this section always reflects the communication channel on which the radio is tuned into for communication. If **PTT** is pressed the radio transmits on the displayed channel. If a signal is received, it is received on the displayed channel.

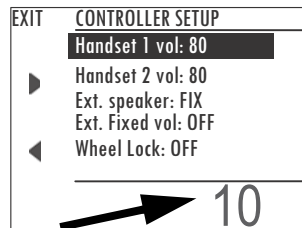

(Example)

## Engagement status

The radio is engaged when you press **PTT**. This is indicated with the tab  in the display. Engagement protects the communication from being interrupted by incoming DSC calls.

## Reduced transmission power LO

Press the key **1W** to toggle the transmit power between low (1 W, **LO** is displayed) and high (25 W).



## Local mode, 10 dB attenuation

Press the soft key **LOCAL** to add 10 dB attenuation. If **LOCAL** is not in the display, press the soft key **MORE** until **LOCAL** appears in the display.

**Note**

Local mode is automatically exited when selecting channel 16 by pressing **16/C** button. If you want to use attenuation on channel 16 or a call channel, you must set it manually each time.

## US channels: Overriding LOW power for channels 13 and 67

When running in US mode you can override low power on the alternative call channels 13 and 67. Do as follows:

1. With the VHF radio set to 13 and 67, press **PTT** on the speaking device.
2. Press the soft key **OVERRIDE** to transmit with full power.  
When you release the **PTT** button, the transmission power goes back to low.



## Watch

The SAILOR 6222 VHF DSC radio has a watch function with dual or triple watch. In dual watch, the working channel and channel 16 are watched. In triple watch the working channel, channel 16 and the programmed call channel are watched. You can select the working channel in any watch mode by turning the selector knob. If there is a signal in one of the watched channels, the display shows the channel in which the signal is received. For instructions how to setup **TRIPLE WATCH** see *Radio setup* on page 39.

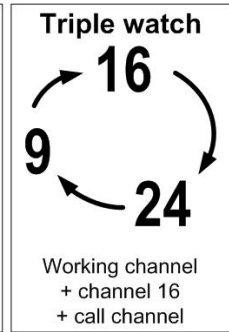
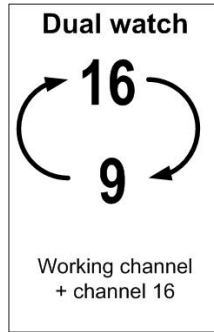

**To start the watch function** press the key **DW**. The radio enters the watch mode and the text WATCH with the channel numbers watched is shown below the current channel number.



**To stop the watch function** press the key **DW** again or **PTT** on the speaking device.

CALL	<b>10</b>		
ALERT	<b>WATCH [16]</b>		INT
DROBOS	MMSI:123456789		
MORE	N 12°34.5678	22:07	
	E 123°45.6789	GPS	

## Scan

The radio has a scanning function for tagged voice channels. Any available voice channel, including weather and private channels, can be tagged and added to the scanning sequence. As default the radio scans with priority scanning of channel 16. If a signal is received while in any scanning mode, only channel 16 continues to be watched.

If there is a signal in one of the scanned channels, the display shows the channel in which the signal is received. If PTT is pressed while scanning, the scanning stops, the radio is tuned into the displayed channel and transmission starts immediately on the displayed working channel.

**To start scanning** press the soft key **SCAN**. The SCAN menu is shown. Press **START** to start scanning. To leave the SCAN menu, but not the scanning procedure, press **EXIT**.

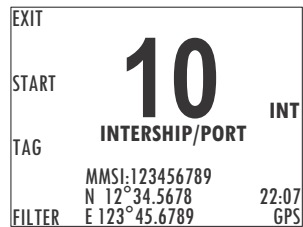

**To stop scanning** press **STOP**, **QUIT** if not in the SCAN menu, or press **PTT** on the speaking device.

**To tag a channel for scanning** turn the selector knob until the wanted channel is in the display. Then press the soft key **TAG**. The display shows the channel number and the word **TAG** at the right side of the display.

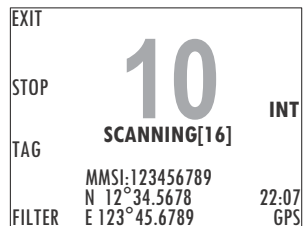

**To remove a channel from the scanning sequence** turn the selector knob until the tagged channel is displayed. Then press the soft key **TAG** to remove the tag.

To see only tagged channels press the soft key **FILTER** and turn the selector knob. Press the soft key **FILTER** to leave the FILTER function. For details how to set up the scanning function see *Radio setup* on page 39.

**Note**

The displayed working channel is temporarily included in the scanning list (although no TAG icon is shown).

## DSC calls

In this section of the manual you find information on:

- *Sending, acknowledging and cancelling own distress*
- *DROBOSE — Distress Relay on behalf of someone else*
- *Receiving distress calls*
- *DSC calls for communication*

### Sending, acknowledging and cancelling own distress

#### To send a distress message

1. Lift the cover of the red distress button and press and hold the distress button for longer than 3 seconds. For short step-by-step instructions how to proceed when sending a distress message see *Emergency calls* on page vi.



When the distress signal is sent, **CH70** and **TX** appear in the display. A two-seconds steady tone is heard.

2. The radio watches for a DSC acknowledgement transmission on channel 70.
3. To pause the automatic resend procedure press the soft key **PAUSE**.
4. To annul the distress message press the soft key **ANNUL**. See also *To cancel own distress* on page 23.
5. When a distress acknowledgement is received, a pop-up window is displayed. Start distress communication on channel 16 to inform about your distress situation.

ANNUL	<b>OWN DISTRESS</b>
	WAIT FOR ACK: 0:00:19
	REPEAT IN: 3:38
PAUSE	D. MMSI: 273000000
	NAT: UNDESIGNATED
	LAT: N 12° 34.5678
	LONG: E 123° 45.6789
POS	MODE: SIMPLEX TP
	CH: 16
	<b>16</b>

#### Note

If no distress acknowledgement is received within a period of 3,5 to 4,5 minutes, the distress message will automatically be retransmitted.

Having pressed the red distress button and sent the distress message, the following information is displayed:

- STATION: shows the radio's MMSI number.
- NAT: shows the nature of distress, see also *ALERT: To send a distress message with specified nature.*
- LAT:, LON:, POS UTC: shows the distress position data as transmitted.
- MODE: shows the communication mode.
- Elapsed time after initiation of own distress.
- Time to next repeat of sending own distress.

If you sent a distress message, the VHF radio is automatically set to channel 16, the channel reserved for international distress, safety and calling.

### ALERT: To send a distress message with specified nature

When sending distress messages you can include the distress nature in the message. To include the distress nature in the distress message do as follows:

1. From top-level standby press the soft key **ALERT**. If it is not in the display, press the soft key **MORE** until **ALERT** appears.  
If the current position information is not correct, you can manually enter it by using the soft key **POS**.
2. Press the selector knob, then turn it to select a nature of distress:  
FIRE, EXPLOSION  
FLOODING  
COLLISION  
GROUNDING  
LISTING (in danger of capsizing)  
SINKING  
DISABLED (and adrift)  
UNDESIGNATED  
ABANDONING (ship)  
PIRACY (armed robbery attack)  
MAN OVERBOARD

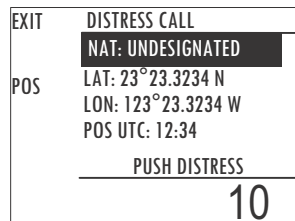

3. Press the selector knob to accept the selected nature of distress.
4. Then lift the cover of the red distress button and push the **Distress button** for 3 seconds.



## To receive acknowledgement of own distress

When the SAILOR 6222 VHF DSC receives an acknowledgement of distress from another vessel or station, a 2-tone alarm sounds. The display shows a pop-up window with the MMSI number of the station who sent the distress acknowledgement call.

- Press **SILENT** to switch off the 2-tone alarm.
- Press the soft key **VIEW** to display further data for this call.
- Press **VIEW** again to return to the working display.

	OWN DISTRESS
QUIT	ACKNOWLEDGED: 0:00:24
	FROM: 002730000
VIEW	D. MMSI: 273000000
	NAT: UNDESIGNATED
	LAT: N 12° 34.5678 12:46
	LON: E 123° 45.6789
HOLD	MODE: SIMPLEX TP
	CH: 16
	<b>16</b> TX

If the same Distress call comes in more than once, the 2-tone alarm sounds briefly and terminates automatically.

## To cancel own distress

If you need to cancel a sent distress message do as follows:

1. The display shows that a distress message has been sent. Press the soft key **ANNUL**. A pop-up window is displayed.
2. Press the soft key **YES** to go ahead with the cancelling process. At this stage you have the option to press the soft key **NO** to return to distress sending procedure.
3. The SAILOR 6222 VHF DSC will send the self-cancellation call on channel 70 and the display automatically shows the message that you should say when cancelling the distress with a radio message.  
Use the selector knob to scroll through all displays with information for the voice cancel.
4. Press the soft key **OK** to go to the acknowledged state. Own distress is cancelled now.

5. Press the soft key **ANNUL** to repeat the sending of the annul DSC message.
6. Having finished the voice cancelling of the annulment press the soft key **QUIT** to quit the annulment Distress procedure.

### Power failure while in distress

In case of a power failure or switch-off during the transmission of a Distress the SAILOR 6222 VHF DSC gives an audible warning after power-up and automatically resumes sending Distress 10 seconds after power up.

Within the 10 seconds you have the following options:

- Press the soft key **QUIT** to terminate the active distress procedure (acknowledged or unacknowledged).
- Press the soft key **CONFIRM** (or wait and do nothing) to resume the sending Distress procedure.

### Sending a Distress from the SAILOR 6103 Multi Alarm Panel

The optional SAILOR 6103 Multi Alarm Panel will, when connected to the VHF radio, indicate in the SAILOR 6103 Multi Alarm Panel display that a Distress can be sent over VHF. To send a Distress alert from the SAILOR 6103 Multi Alarm Panel, do as follows:



1. Lift the cover of the Distress button marked **VHF**.
2. Press and hold the button until the light is steady and the buzzer stops (more than 3 seconds).

The VHF radio is now in distress mode. Continue the distress traffic and procedures from the VHF radio front panel, if possible, in the same way as described for handling distress mode from the main VHF radio.

Press the **MUTE** button on the Alarm panel to mute the audible alarm on incoming distress or urgency messages.

**Note** Only undesignated distress messages can be initiated from the Alarm Panel.

For further information see the Alarm Panel Installation and user manual.

## DROBOSE — Distress Relay on behalf of someone else

To send a distress message on behalf of someone else, do as follows:

1. From top-level standby press the soft key **DROBOS**. If it is not in the display, press the soft key **MORE** until **DROBOS** appears.
2. Select one line at a time by pressing and turning the selector knob.
3. Enter the necessary information using the selector knob or the keypad:

EXIT	DISTRESS RELAY
	Type: RELAY INDIV:
	DISTRESS MMSI:
PHBOOK	Unknown
	To:
	NAT: UNDESIGNATED
	LAT: Unknown
	10

Relay items	Description
TYPE:	Select RELAY ALL or RELAY INDIV. If yo select RELAY INDIV., the field TO appears in the display.
DISTRESS MMSI:	Enter the MMSI number of the vessel in distress, if known, or else “unknown”
TO:	Enter the MMSI number of the coast station you send the relay to.
NATURE:	Select the nature of distress: FIRE, EXPLOSION FLOODING COLLISION GROUNDING LISTING (in danger of capsizing) SINKING DISABLED (and adrift) UNDESIGNATED ABANDONING (ship) PIRACY (armed robbery attack) MAN OVERBOARD EPIRB
LAT: LON: POS UTC:	Enter the position and UTC information or unknown of the vessel in distress.

- Lift the cover of the red distress button and push the **Distress button** for 3 seconds.

## Receiving distress calls

When the radio receives a distress call, the 2-tone alarm sounds. Types of distress calls are DISTRESS, DISTRESS ACK, DISTRESS RELAY and DISTR. RELAY ACK.

- To switch off the 2-tone alarm press the soft key **SILENT**.
- Press the soft key **VIEW** to display further information. If engaged in other communications press **ACTIVE** to engage in the received DSC call.
- Monitor channel 16 as a coast station may require your assistance. If the radio is not on channel 16, turn the selector knob or use the key **16/C** to go to channel 16.
- When the radio receives the first distress acknowledgement call a 2-tone alarm sounds again. To switch off the 2-tone alarm press the soft key **SILENT**.
- If you decide to acknowledge the Distress press **MORE** until **ACK** is shown in the display.

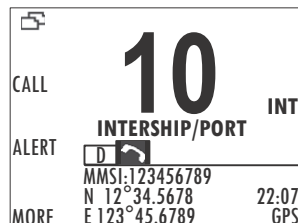
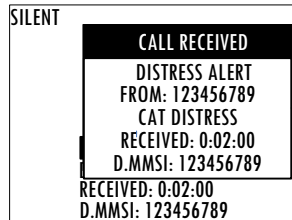

## Distress call with errors

If a distress call contains errors, it is still received.

Press soft key **OK** and press **VIEW** for more information. Errors are marked with underscores ( \_ ).

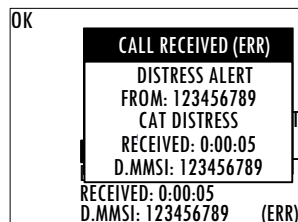



## Distress call log

As long as you are part of a distress session, i.e. you have not pressed **QUIT**, you receive distress messages and can track all distress messages for the current distress event.

1. Press the soft key **HIST**. If it is not in the display, press the soft key **MORE** until **HIST** appears.
2. Press the soft key **▶** or **◀** to browse the received Distress messages.
3. Press the soft key **EXIT** to leave the event HISTORY.

## Receiving distress calls from Man Over Board devices

The SAILOR 6222 VHF DSC supports specific handling of Man Over Board devices (MOB). The MOB can operate in a closed loop configuration (sending distress relay calls) and/or open loop mode (sending distress calls).

A specific received distress session is initiated for MOB devices.

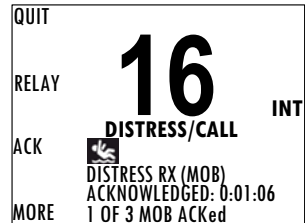

Any call which originates from a modern MOB device will be handled within a single procedure. You will be able to see the acknowledgement status of (up to 50) involved MOB devices in parallel (i.e. 1 out of 3 MOB devices is acknowledged).

The detailed status of each MOB device can be examined in the detail VIEW. It is possible to browse through all MOB devices by pushing the selector knob, while the index line (on top) is visible, and then turn the selector knob. Push/toggle selector wheel to examine details for the individual MOB device.

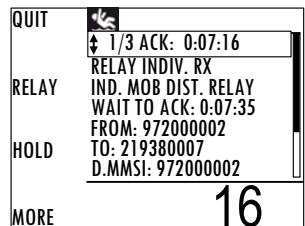



The MOB distress relay calls (closed loop) can be relayed or individually acknowledged when the person is located or secured.

MOB distress calls (open loop) may be acknowledged only if permitted by a coast station.

If the closed loop configuration of the vessels MOB devices is with a group MMSI, the group MMSI must be programmed and activated in the Phone Book (See *Phone book* on page 35)

## DSC calls for communication

With a DSC call you can establish a radio communication with one or several specific radios on a suggested VHF channel.

 <p>Radio A</p>	<ol style="list-style-type: none"> <li>1. <b>DSC call message</b> from Radio A to Radio B</li> <li>2. <b>DSC acknowledge</b> from Radio B to Radio A</li> <li>3. Radio A + B go on the <b>agreed VHF channel</b></li> <li>4. Press <b>PTT</b> and start talking</li> </ol>	 <p>Radio B</p>
--	--	--

To make a DSC call, do as follows:

1. Press the soft key **CALL**.
2. Turn and press the selector knob to select the call type:

EXIT	DSC CALL
	Type: INDIVIDUAL
	Cat: ROUTINE
PHBOOK	To: <span style="background-color: black; color: black;">XXXXXXXXXX</span>
	Ch: 9
10	

Depending on the DSC call type you can enter category, MMSI number and channel for the following communication. In the field **CAT**: select a DSC call category, depending on the call type.

DSC call type	Cat.	To:	Ch.	Session icon	DSC call category
INDIVIDUAL (default)	X	X	X	<b>U, S or R</b>	Routine (default), urgency or safety calls, calls to a ship or a station
SAFETY TEST	—	X	—	<b>S</b>	Test call, check of safety equipment
POSITION	—	X	—	<b>S</b>	Safety
GROUP	—	X	X	<b>R</b>	Routine
ALL SHIPS	X	—	X	<b>S or U</b>	Safety (default) or urgency

3. In the field **TO**: enter the 9-digit MMSI number of the vessel you want to contact or use the phone book (**PHBOOK**) to select a contact.
4. In the field **CH**: enter the suggested VHF channel for following communication.
5. Press the soft key **SEND** to make the call.

## What is a Session?

A DSC session is defined as a collection of DSC calls (transmitted and/or received) that are related to the same event (e.g. a distress event) or established call (e.g. an individual call request followed by an acknowledgement).



A session can be either active or on hold. The active session has control over the radio transmitter. A session can have a purpose. For example if the purpose is to establish a communication on a working channel.

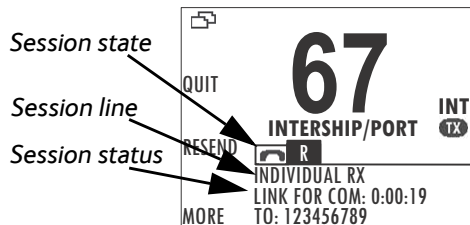

The non-DSC VHF communication is considered as a session that can be active (engaged) or on hold (dis-engaged). See also *Engagement status* on page 18.

## Display for a session

In the DSC window the type of session, the current state, MMSI number of the other party and elapsed time since the reception of a call request or an acknowledgment is shown.



The session state icons, in the example  and , show the state of the session:

- **ACTIVE** — inverted, transmitter tuned into the communication channel in the example , a DSC Routine call).
- **HOLD** — normal view, parked session (in the example , VHF voice communication).

For more information on the session state icons see *Session state icons* on page 34.

The DSC Session line can be one of the following:

<b>Session line</b>	<b>Explanation</b>
OWN DISTRESS	The ship is in own distress. See also <i>To send a distress message</i> on page 21.
DISTRESS RX	You watch or participate in a distress communication for another station in distress
DISTRESS RX (MOB)	You watch or participate in an MOB distress event involving one or more MOB devices
RELAY calls (numerous)	You watch or participate in a distress communication for another station in distress
ALL SHIPS TX/RX	You have sent / received an all ships call
GROUP TX/RX	You have sent / received a group call
INDIVIDUAL TX/RX	You have either sent a call request to a station to establish contact, or another station has made a call to you to establish contact. The call needs a reply.
TEST TX/RX	You either have sent a SAFETY TEST call or have received a SAFETY TEST call from another station that needs to be replied.
POSITION TX/RX	A position request was either sent or received.

The session status can be one of the following:

<b>Session status</b>	<b>Explanation</b>
WAIT FOR ACKNOWLEDGE	You made an individual call to a station and are awaiting a reply to establish connection.
OCCUPIED	The DSC transmission mechanism waits until the DSC channel (70) is free.
TRANSMITTING	Transmission of a DSC message is ongoing.

Session status	Explanation
LINK FOR COM	The communication has been established in a routine call.
ACKNOWLEDGED	The call requiring (or not requiring) an acknowledgement has been acknowledged.

### Soft keys to control DSC sessions

Call or session types vary in control options, and options may also change if a session changes its state. The following table gives an overview of the DSC soft key commands available:

Soft key — DSC session	Radio function
QUIT	Terminates the DSC session
HOLD	Puts the DSC session hold if it is active (return to other non-DSC functions)
ACTIVE	Activates the DSC session
VIEW	Shows details about the DSC call
RESEND	Transmits an identical call if available
NEWCH	Replies with a new channel if an individual call is received with a communication channel specified which is not available in the radio, or the operator decides to change the channel.
UNABLE	Constructs a reply to the caller if an individual call is received which is not compatible with the radio modes.
SILENT	Silences alarms.
ACK	Acknowledges a received call request with the suggested parameters.
POS (Own Distress)	A shortcut to own position data information.

Soft key — DSC session	Radio function
PAUSE (Own Distress)	Pauses the automatic repetition of distress transmissions
RESUME (Own Distress)	Resumes automatic repetition of distress transmissions (if paused)
ACK	Distress acknowledgement.
DROBOS	Distress Relay on behalf of someone else.
ANNUL (Cancel Own Distress)	Cancels an inadvertently transmitted distress
CONFIRM (Cancel Own Distress)	Confirms action and proceed sequence, used in cancel distress procedure
VIEW (in Cancel Own Distress)	Turns page of text message.
HIST (Received distress)	A filtered version of the log displaying received calls relevant to the current distress event.

See also *Handling multiple calls — DSC and voice* on page 34.

### Detail information for DSC sessions (soft key: VIEW)

A DSC session is updated based on DSC calls received or transmitted. Press the soft key **VIEW** to show the details for the current session. For distress events a sequence of calls may contribute to the complete view and status of the session. Detailed fields for distress are:

INFO — DSC	Explanation
DISTR-MMSI	The vessel in distress
NAT	Nature of Distress
LAT	Latitude position of station in distress
LON	Longitude position of station in distress

INFO — DSC	Explanation
POS UTC	Time of position
MODE	Communication mode (Simplex/Semi-duplex Telephony supported)

For other session types the soft key function **VIEW** typically shows the details from a single call. Detail fields for other calls than distress are:

INFO —other calls	Explanation
CALL Type	(on received call) – This may be shown on call reception
CAT	Category of the call: Urgency, Safety or Routine
FROM	The initiator of the call
TO	The intended receiver of the call (unless All Ships)
MODE	Communication mode (Simplex/Semi-duplex Telephony supported)
CHANNEL	Subsequent communication channel
LAT	Latitude position returned upon a position request
LON	Longitude position of station in distress
POS UTC	Time of position

## Receiving DSC calls

If the radio is in stand-by mode, i.e. not engaged in another session, and a DSC call is received the call details are shown on the display.

After having silenced the alarm you can acknowledge the call, put it on hold or display more information.

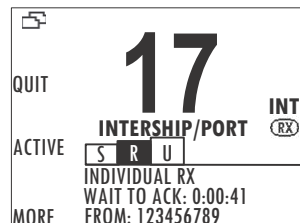

## Handling multiple calls — DSC and voice



The SAILOR 6222 VHF DSC can control multiple DSC sessions simultaneously with a VHF communication session. All sessions can keep track of their session state and the communication channel used. They are handled in their respective sessions, in the order as they are started up.

### Note

Note that there is only one active session at a time. The active session controls the radio transmitter.

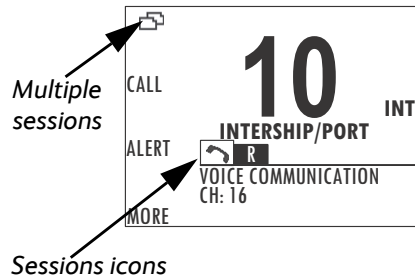
You can toggle between the ongoing calls/sessions, that means that a call — or session — can be on hold or active. If there are several calls ongoing, they are shown in the display with their respective state (active, on hold, requiring attention). Use the soft key  to leaf through all ongoing calls or sessions. The DSC sessions on hold can receive calls that are pertinent to the session, even when the session is not displayed.



The example on this page shows that two sessions are ongoing, the inverted  is a routine DSC call (active),  is a non-DSC initiated voice communication (on hold). Press the soft key **ACTIVE** (press more if not visible) to make the voice session active and put the DSC call session on hold.



If engaged in a DSC session and if you want to engage in a non-DSC voice communication, be sure to press HOLD on the active DSC session and then press PTT to engage.



### Session state icons

Session icons in the session view inform you of the category of the DSC call or Voice communication:

- D — Distress
- U — Urgency



- S — Safety
- R — Routine
-  — Voice (VHF voice call, non-DSC)
-  — MOB Distress event (closed loop/open loop)

State of session icon	Meaning for the current call (DSC or voice)
 (inverted)	Active call/session
	Call on hold

## Phone book

Use the phone book when making a DSC call. You can enter up to 200 contacts. A contact has the following details:

- Name (up to 12 characters)
- Type (SHIP, GROUP or COAST STATION)
- MMSI number
- Channel
- Position Auto Acknowledge (yes or no) or Listen to Group

The phone book is always sorted alphabetically by contact names. Use the soft key **FILTER** to toggle between CONTACTS - ALL, COAST, SHIP or GROUP. After having selected a contact, the phone book closes automatically.

## Using the phone book to make a DSC call

To call a contact in the phone book do as follows:

1. Press the soft key **CALL**. If it is not in the display, press the soft key **MORE** until **CALL** appears. The DSC call composer is shown in the display.
2. Press the soft key **PHBOOK**.

3. Turn the selector knob to scroll to the phone book entry that you want to call, press the selector knob to select the contact.
4. Press the soft key **SEND** to make the call.

## Adding a contact to the phone book

To add a contact to the phone book do as follows:

1. Press the soft key **PHBOOK**. If it is not in the display, press the soft key **MORE** until **PHBOOK** appears in the display.
2. Press the soft key **ADD** and fill in the details for the new contact.

Contact	Description
NAME	Enter the name by turning the selector knob to the desired letter, press the selector knob to accept the letter and advance to the next letter. To finish press the soft key <b>OK</b> . It is also possible to use the keypad to enter the name.
TYPE	Press and turn the selector knob to select SHIP, GROUP or COAST STATION.
MMSI	Turn and press the selector knob to enter the contact's MMSI number (9 digits), press the soft key <b>OK</b> to accept. For coast station contacts you can also enter a DSC channel. It is also possible to use the keypad to enter the MMSI.
Ch (optional)	Press and turn the selector knob to select the preferred channel for this contact, press the soft key <b>OK</b> . It is also possible to use the keypad to enter a channel.
Position Auto Ack	For SHIP or COAST STATION: Press and turn the selector knob to select YES or NO for this contact, press the soft key <b>OK</b> . This will allow auto-ack of position requests for this contact.
Listen to Group	For GROUP: Press and turn the selector knob to select YES or NO for this contact, press the soft key <b>OK</b> . The radio will respond to calls to the specified group.

3. Press the soft key **SAVE** to save the contact information.
4. Press the soft key **EXIT** to leave the phone book.

## Editing a contact

1. Press the soft key **PHBOOK**. If it is not in the display, press the soft key **MORE** until **PHBOOK** appears.
2. Press the soft key **EDIT**.
3. Press and turn the selector knob to browse through the details of the contact and continue as described in *Adding a contact to the phone book* from step 2 onwards.

## Deleting a contact

1. Press the soft key **PHBOOK**. If it is not in the display, press the soft key **MORE** until **PHBOOK** appears.
2. Turn the selector knob to browse to the contact you want to delete.
3. Press the soft key **MORE** until **DELETE** appears.
4. Press the soft key **DELETE**.
5. Press **EXIT** to leave the phone book and return to VHF operation.

## Replay function

Replay allows the operator to playback received voice messages in the loudspeaker. Recording is activated automatically when a signal is received. Recording is not possible during playback. Up to 60 tracks or 240 seconds can be handled. During a power cycle the recorded tracks are deleted.

The recorded channel is displayed. The message length is shown in seconds. The display shows how old the message is. If the 240 s storage limit is reached, the oldest data is overwritten.

### Note

The replay function can be started even in a distress situation. If a DSC call is received the replay function continues the playback. Acknowledgement of the DSC call immediately initiates and activates the DSC session. You can initiate replay again from any session afterwards.

## Replaying recorded messages

Press the Replay button (short press). The latest message (message) is repeated. Information about this message is shown in the display.



**To stop replaying** the message press the soft key **STOP**.

**To rewind** through the recorded messages make a long press on the Replay button.

**To stop replaying** a message press **STOP** or the PTT button on the speaking device.

If a signal is received while in replay mode the display shows  in the display.

## Setup

The following setup pages are described in this section of the manual:

- *Radio setup*
- *Channel setup*

- *Power Supply*
- *DSC setup*
- *DSC call logs*
- *System setup*
- *Controller setup*

## Accessing a setup page

To change a setting in one of the **SETUP** pages, do as follows

1. Press the soft key **SETUP**. If it is not in the display, press the soft key **MORE** until **SETUP** appears.
2. Press the arrow soft key ► or ◀ to advance to **SETUP** page you want to edit.
3. Turn the selector knob to go to a setting, then press the selector knob to change the setting.
4. Press **EXIT** to return to normal radio operation.

## Radio setup

Parameter	Description
<b>Scan Hang Time</b>	Scan hang time, in seconds on an active receiving working channel. The time is measured from the signal is detected. The radio remains on the channel for the set time interval, if a signal was detected.  <b>OFF:</b> Resumes scanning when signal disappears (default) <b>4, 6, 8, 10:</b> Hang time in seconds.
<b>Scan Resume</b>	Scan resume time, in seconds. When the programmed time of inactivity has elapsed, and when watch/scan has been aborted using a press on PTT, or after power-up, scan or watch is resumed.  <b>OFF:</b> Automatic resume is deactivated (default) <b>3, 6, 10, 15, 20, 25, 30:</b> Resume time in seconds.

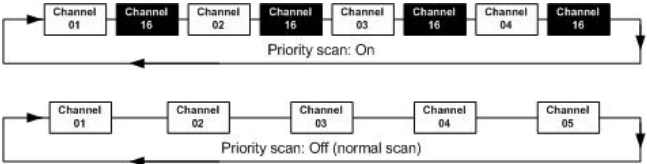
Parameter	Description
<p><b>Watch Mode</b></p>	<p><b>DUAL:</b> Dual watch monitoring the working channel and the priority channel (channel 16, default for international channels).</p> <p><b>TRIPLE:</b> Triple watch. The working channel is watched with the priority channel (channel 16) and the programmed call channel (if any, otherwise dual watch).</p>
<p><b>Priority Scan</b></p>	<p><b>ON:</b> All channels tagged for scanning are scanned while monitoring channel 16. (default).</p> <p><b>OFF:</b> Only the channels tagged for scanning are scanned in sequence, not channel 16, unless it is tagged for scanning.</p> 
<p><b>ATIS code</b></p>	<p>The ATIS code (Automatic Transmitter Identification System) is used for identification to marine coast and inland stations and its use is mandatory in a number of European inland waterways such as e.g. the river Rhine. Like the MMSI number the ATIS number is issued by the relevant authority.</p> <p>ATIS for foreign leisure crafts: For ships coming from states which are not member of the Regional Arrangement the ATIS-Code is based on the MMSI with a 9 as the first digit.<sup>a</sup></p> <p><b>Note:</b> The ATIS number can be programmed once. If a wrong number has been entered and stored, or if there is a requirement to change it, contact your authorized dealer.</p>

a. The Committee Rainwat in its 12. Meeting (October 2008) decided to change the building rules of the ATIS code for vessels coming from a country outside the RAINWAT arrangement.

## Channel setup

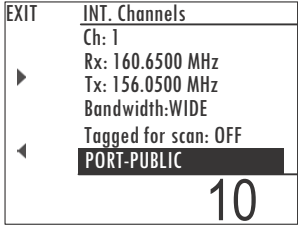
Parameter	Description
<b>Channel Mode</b>	To select the channel table for the primary channel. Channel tables available: <b>INT, BI, US, CA, ALT</b> . See also <i>VHF channel table</i> on page 17.
<b>Bandwidth</b>	<p>Selection of the bandwidth for the fixed pre-programmed channels. This is recommended from Radio Regulations:</p> <p><b>Wide:</b> Wide band is 25kHz channel bandwidth (default)  <b>Narrow:</b> Narrow band defines a channel bandwidth of 12.5kHz</p> <p>Channel number display in narrow band mode:</p> <ul style="list-style-type: none"> <li>• <b>2xx</b> if the channel frequency is outside the wideband frequency grid.</li> <li>• <b>4xx</b> if the channel frequency is on the wideband grid.</li> </ul>
<b>Call Channel</b>	Select the channel you want to use as a programmed call channel. This channel is used as one channel in triple watch and when you make a long press on the <b>16/C</b> button.
<b>INT. Channels</b>	<p>You can view the channel settings. Press the soft key <b>▶</b> to advance the channel numbers.</p> <p>Bandwidth: <b>WIDE</b> (default) or <b>NARROW</b>          Tagged for scan: <b>OFF</b> (default) or <b>ON</b></p>  <p>Edit the service line text by pressing the selector wheel and enter new name by wheel or keypad.</p> <p>For customizing, contact your authorized dealer.          Press the soft key <b>EXIT</b> to return to <b>CHANNEL SETUP</b>.</p>
<b>BI. Channels</b>	As described above.

Parameter	Description
<b>US. Channels</b>	As described above.
<b>CA. Channels</b>	As described above.
<b>ALT. Channels</b>	As described above.
<b>Private Channels</b>	As described above.

## Power Supply

Parameter	Description
<b>Monitor</b>	Set this to <b>ENABLED</b> if the radio is connected to a TT-6081A Power Supply and Charger. Set this to <b>DISABLED</b> for any other power supply.
<b>Status</b>	Visible if ENABLED. Current status of the connected power supply.
<b>Voltage</b>	Visible if ENABLED. Current voltage.
<b>Current</b>	Visible if ENABLED. Current current.

## DSC setup

DSC setting	Description
<b>Position &amp; MMSI</b>	Available position information. Here you can enter position data and UTC time manually. See also <i>Position and MMSI number</i> on page 12 for a step-by-step description.
<b>DSC Groups</b>	Shows DSC groups. You can also add, edit, filter and delete groups here.



DSC setting	Description
<b>Auto-Ack Test</b>	Auto-acknowledgement of test DSC messages. <b>OFF</b> or <b>ON</b> (default)
<b>Auto-Ack Polling</b>	Auto-acknowledgement of polling DSC messages. <b>OFF</b> or <b>ON</b> (default)
<b>Auto-Ack Position</b>	Auto-acknowledgement of position DSC messages. <b>OFF</b> (default) or <b>ON</b>
<b>Auto-Ack Individual</b>	Auto acknowledgement of individually addressed, non distress DSC messages <b>OFF</b> or <b>ON</b> (default)
<b>Non-Distr. Inactivity</b>	Inactivity time-out to exit non-distress functions (e.g. in setup) without automatic time-out (OFF): Range: OFF, 1 to 30 minutes, in 1 min. steps Default: <b>15min.</b>
<b>Distress Inactivity</b>	Inactivity time-out for received distress DSC automated procedures without automatic time-out: Range: OFF, 1 to 30 minutes, in 1 min. steps Default: <b>OFF</b>
<b>Comm Inactivity</b>	Inactivity time-out of non DSC communication (VHF). Range: 10 to 600 seconds, in 10 s steps Default: <b>30sec</b>
<b>Non-Distr.Alarms</b>	Non-distress DSC alarms <b>OFF</b> : Disabled <b>ON</b> : Enabled (default)
<b>Medical transport</b>	<b>ON</b> : This option is available in DSC calls of the type Urgency. <b>OFF</b> (default)
<b>Neutral crafts</b>	<b>ON</b> : This option is available in DSC calls of the type Urgency. <b>OFF</b> (default)

DSC setting	Description
<b>Print DSC</b>	For printing of DSC messages on a printer connected to the system. <b>ON</b> or <b>OFF</b> : (default)
<b>DSC Self Test</b>	You can set the radio to run a DSC self test. <b>OFF</b> : Disabled (default) <b>RUN</b> : Run test. For further details about this test see <i>DSC routine testing</i> on page 55.

## DSC call logs

Use the soft keys ► and ◀ to leaf through all logs.

DSC call log	Description
<b>Received Distress</b>	Shows a log of up to 100 received distress calls.
<b>Transmitted Calls</b>	Shows a log of up to 100 transmitted calls.
<b>Received Calls</b>	Shows a log of up to 100 received non-distress calls.

## System setup

SYSTEM SETUP	Description
<b>Printer Config</b>	Select a printer (if one or several printers are part of the system). Note whether there is immediate print upon DSC activity, You must set Print DSC to ON see <i>DSC SETUP</i> on page 49. Recommended commercially available printer-servers: — Trendnet TE100 P1U — D-Link DPR-1020 — SAILOR 6004 Control Panel
<b>System time &amp; Date</b>	View and set system time and date

SYSTEM SETUP	Description
<b>Inactivity timeout</b>	Inactivity time-out to exit functions (e.g. in setup) and return to the application. Range: 1 to 30 minutes, in 1 minute steps Default: 10 min.
<b>Language</b>	English
<b>Theme</b>	Changes the display colour. <b>BlackOnWhite</b> (default) <b>WhiteOnBlack</b>
<b>GPS Input</b>	<p>Select the position input source</p> <p><b>Automatic:</b> Automatically select position source with the best quality.</p> <p>In <b>Automatic</b> mode the position device transmitting sentences with the best quality indicator will be used as position source.</p> <p><b>Manual mode</b></p> <p><b>NMEA:</b> Low speed NMEA position input</p> <p><b>NMEA HS:</b> High speed NMEA position input</p> <p><b>LWE1:</b> Specific LWE position input (see LWE Talkers below)</p> <p><b>LWE2:</b> Specific LWE position input (see LWE Talkers below)</p> <p><b>LWE3:</b> Specific LWE position input (see LWE Talkers below)</p> <p><b>INM-C:</b> SAILOR Inmarsat C position input</p>

SYSTEM SETUP	Description
<p><b>Current Src</b></p>	<p>Reports the current input used as the position source</p> <p><b>NMEA</b></p> <p><b>NMEA HS</b></p> <p><b>INM-C</b></p> <p>Or the LWE talker ID of the current position source device on LAN</p>
<p><b>NMEA in (baud)</b> (only displayed when <b>NMEA</b> or <b>NMEA HS</b> is selected)</p>	<p>The actual baud rate of the NMEA input port selected</p> <p><b>4800</b> (NMEA)</p> <p><b>38400</b> (NMEA HS)</p>
<p><b>LWE Talkers</b> (only displayed when <b>Automatic</b> or one of the <b>LWE</b> sources is selected)</p>	<p>When Automatic mode is selected <b>updating</b> is shown to indicate the equipment is currently scanning for SAILOR DGNSS 6588 devices on the LAN network.</p> <p>This process may take up to 40 seconds.</p>
<p>- <b>LWE1</b></p> <p>- <b>LWE2</b></p> <p>- <b>LWE3</b></p> <p>Or</p> <p>- ⚡ <b>LWE1</b></p> <p>- ⚡ <b>LWE2</b></p> <p>- ⚡ <b>LWE3</b></p>	<p><b>CCXXXX</b> In automatic mode this position holds the highest priority SAILOR DGNSS 6588 position source after a scan.</p> <p>If a third party position source shall be used in the LWE priority, the LWE talker is simply programmed on the desired priority position (LWE1, LWE2 or LWE3). A manually programmed source is indicated by a key symbol (⚡). The manually programmed LWE sources can be removed by deleting the entry completely.</p>
<p><b>LWE Identity</b></p>	<p><b>CCXXXX</b> As default the device identity is automatically created. Manual override requires password entry.</p>

SYSTEM SETUP	Description
<b>Factory Defaults</b>	Resets the radio to factory defaults. Press the selector knob and confirm the reset to factory default.
<b>Radio Info:</b>	<b>SW Version:</b> Software version of the radio <b>S/N:</b> Serial number of the radio <b>IP:</b> IP address of the radio
<b>Password</b>	If you need to change the identity of the radio (MMSI number or ATIS code), contact your local dealer.

## Controller setup

Each of the controlling devices connected and powered has its own setting. The available settings may vary from controllers applied.

Controlling device	Description
<b>Handset 1 vol:</b>	Adjust earpiece volume for handset 1: ON, can be adjusted from OFF to 100, in steps of 5. <b>Note:</b> The handset connected to the front connector has top priority and is configured to ON.
<b>Handset 2 vol:</b>	Adjust earpiece volume for handset 2: ON, can be adjusted from OFF to 100, in steps of 5.
<b>Ext. speaker</b>	<b>FIX:</b> Fixed level is set for external speaker <b>REL:</b> Relative level following volume adjustment of the internal speaker
<b>Ext. fixed vol:</b>	External speaker fixed volume: <b>OFF</b> , 5 to 100 in steps of 5

Controlling device	Description
<b>Wheel lock:</b>	<p>You can set a time interval after which the SQ, volume and selector knobs are locked and protected against unintentional use. Then a lock symbol is shown in the display. Press any key to unlock the knobs.</p> <p><b>OFF</b>, 10s, 20s, 30s, 40s, 50s, 60s</p>

### Top-level standby soft-key functions and setup pages

Top-level standby	
CALL	EXIT PHBOOK
ALERT	EXIT POS
DROBOS	EXIT PHBOOK
SCAN	EXIT START TAG FILTER
LOCAL	
PHBOOK	EXIT ADD FILTER DEL
SETUP	EXIT ▶ ◀

<b>Setup pages</b>	
RADIO SETUP	Scan Hang Time Scan Resume Watch mode Priority Scan ATIS code
CHANNEL SETUP	Channel Mode Bandwidth Call Channel Int. Channels BI. Channels US. Channels CA. Channels ALT. Channels Private Channels
POWER SUPPLY	Monitor
DSC SETUP	Positon & MMSI DSC groups Auto-Ack Test Auto-Ack Polling Auto-Ack Position Auto-Ack Individual Non-Distr. Inactivity Distress Inactivity Comm Inactivity Non-Distr. Alarms Medical transport Neutral craft Print DSC DSC Self Test
DSC CALL LOGS	Received Distress Transmitted Calls Received Calls

<b>Setup pages</b>	
SYSTEM SETUP	Printer Config System time & date Inactivity timeout Language Theme GPS Input NMEA in LWE Talkers LWE Identity Factory Defaults Password Radio Info
CONTROLLER SETUP	Handset 1 vol: Handset 2 vol: Ext. Speaker Ext. fixed vol: Wheel lock



# Service & maintenance

## Contact for support

Contact your authorized dealer for technical service and support of the VHF radio. Before contacting your authorized dealer you can go through the troubleshooting guide to solve some of the most common operational problems.

## Maintenance

### Preventive maintenance

Maintenance of the SAILOR 6222 VHF DSC can be reduced to a maintenance check at each visit of the service staff. Inspect the radio for mechanical damages, salt deposits, corrosion and any foreign material. Due to its robust construction and ruggedness the radio has a long lifetime. Anyway it must carefully be checked at intervals not longer than 12 months - dependent on the current working conditions.

### Salt deposits

In case the equipment has been exposed to sea water there is a risk of salt crystallization on the keys and knobs and they may become inoperable. Clean the VHF radio and speaker microphones with fresh water.

### Error messages and warnings

Errors and warning messages are shown in the display and are read-only.

## DSC self test

To run a control routine DSC self test, do as follows:

1. Press the soft key **SETUP**. If it is not in the display, press the soft key **MORE** until **SETUP** appears.
2. Press the arrow soft key **▶** or **◀** to advance to **DSC SETUP**.
3. Turn the selector knob to select **DSC Self Test**. Press and turn the selector knob to select **RUN**.

The test will check the ability to encode/decode DSC signalling on RF level. The radio will automatically transmit a DSC safety test call to its own MMSI number without enabling the transmitter power amplifier. In parallel the radio decodes and compares the received call to be the same as the transmitted.

The display shows the result of the test.

4. Press the soft key **OK** to acknowledge the test result and resume normal operation.

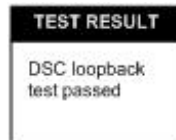

**Important**

If the DSC loopback test fails, this indicates the DSC functionality does not work correctly — including the ability to send a DISTRESS message.

Contact your dealer immediately for further advice.

## Troubleshooting guide

Action	Symptom	Remedy
The radio will not turn on	The display is empty.	<p>Check if power is present.</p> <p>Check fuse which is placed in the power connector.</p> <p>Check performance of power supply if connected to one.</p>
No communication	The loud-speaker is mute.	<p>Check the antenna installation.</p> <p>Check antenna cable.</p> <p>Check handset/Handmicrophone and cable.</p>
GPS	Position requested.	<p>Check the GPS input is correct. For setting GPS input see the Installation guide 98-132281.</p> <p>If the VHF, despite being connected to a GPS/position source, prompts for entering the position and time information, the automated update has most likely been lost either due to missing data on the line, broken cabling or the GPS/position source has failed. Refer to the installation section in the back of this manual for installation and connection details.</p> <p>Until the automatic position update from GPS/position source is restored position and time must be entered manually when prompted by a (four hour) timer in VHF.</p> <p>In the <b>DSC SETUP, Position Info</b>, you can verify the position data. If data is present Lat/Lon/UTC will be displayed.</p>

Action	Symptom	Remedy
GPS	Position source used is different from the expected	<p>If position input source is set to <b>Automatic</b> position (see System Setup) sentences from the following talkers GP, GL, GN (and GA) are prioritized.</p> <p>Position source is selected by the quality indicator:</p> <ol style="list-style-type: none"> <li>1. Differential</li> <li>2. Precise, Autonomous, Float_RTK, Realtime_RTK</li> <li>3. Estimated and Manuel</li> <li>4. Unknown (for instance if not supported in sentence)</li> <li>5. Simulated and Invalid</li> </ol> <p>On equal priority the following port order is used:</p> <ol style="list-style-type: none"> <li>1. NMEA</li> <li>2. NMEA HS</li> <li>3. LWE1</li> <li>4. LWE2</li> <li>5. LWE3</li> <li>6. INM-C</li> </ol> <p>The device will automatically switch to the position source with the highest priority available after 5 seconds when switching to a lower priority input and 30 seconds when switching to a detected higher priority input.</p>

Action	Symptom	Remedy
GPS	Position source selected via LAN is different from the expected	<p>The SAILOR 6588 DGNSS Receiver can transmit position over LAN/LWE. Automatic discovery and selection of up to three (LWE1, LWE2 and LWE3) SAILOR 6588 DGNSS Receiver source inputs are supported via SLP.</p> <p>If any of the LWE source inputs are manually programmed in System Setup, this will be excluded from automatic discovery.</p> <p>Available source inputs will discover and use the SAILOR 6588 DGNSS Receiver LWE sources with the most important role (primary, secondary, ...)</p>
DSC routine testing		<p>Check the DSC function regularly. Verify the complete DSC installation, with antennas, by transmitting a Safety Test call to another station (coast or ship). The test call is generated using the DSC call flow via menu CALL.</p> <p>The call should normally be replied by the receiving station without questioning. The default configuration of a DSC VHF radio is auto-acknowledgement of any received Safety test call requests. If a ship is equipped with multiple radios a second radio can be the station to check up against. The transmitting radio will not receive its own transmitted calls.</p> <p>If there is only a single radio on a vessel, a facility is built into the unit where the DSC engine can be verified using a test call that is internally looped without activating the radio transmitter PA. The test is executed via menu SETUP, DSC SETUP. The call sequence that is verified, is an Individual Safety Test Call directed to own MMSI. The test status is read in the display.</p>

Action	Symptom	Remedy
Missing MMSI	DSC operation is not working	When powering up the VHF for the first time after leaving factory there is no MMSI number in the VHF radio. For the DSC operation to function the MMSI number must be entered in the VHF radio. For further details see the installation manual.
	Wrong MMSI number	If a wrong number has been entered and stored, or if there is a requirement to change it, contact your authorized dealer.
System time	DSC logs are sorted with wrong time stamp or radio time is incorrect	<p>A wrong radio time indication should occur only if GPS position source is not connected or providing correct time data. A valid GPS time signal will update the UTC time used for time stamping the DSC logs.</p> <p>If a GPS/position source is not connected to the VHF radio and hence position and time is entered manually, you must enter the "radio time" also manually, at least after power up. This will ensure correct time stamping of the DSC logs.</p> <p>The UTC time is the suggested time to be entered when prompted for entering position and time manually (every four hours).</p>
DSC Channel not free	DSC transmission delayed	The transmission of a DSC call which is not of category distress will be postponed if the VHF radio is in the process of decoding an incoming DSC call. As soon as this decoding process has finalized the transmission will take place.
Handset configuration	No sound in earpiece	The earpiece volume may be configured to OFF. See section <i>Controller setup in the user manual</i> on how to adjust the earpiece volume of the handset.

Action	Symptom	Remedy
Device failure		<p>If any of the checks and tests described in this section do not assist in resolving the difficulties experienced in the operation and/or performance of the VHF installation, a fault may have developed in the VHF radio itself.</p> <p>When contacting an authorized Thrane &amp; Thrane representative be sure to provide as much information as possible describing the observed behavior - also including the type of the VHF radio, its serial number, and software release version (both found in the setup menu Controller Setup).</p>
<b>WARNING:</b> POWER SUPPLY LOST CONTACT	Power supply status cannot be monitored.	<p>In Setup, Power Supply, set Monitor to disabled.</p> <p>You can only monitor the power supply if the radio is powered by a SAILOR 6081 Power Supply Unit and Charger.</p>

Action	Symptom	Remedy
System Time & Date	Manually entered time & date is overridden	<p>If valid time information is received via NMEA LWE on LAN port, this time source is used to set the system time. If this is not wanted, disconnect LAN cable. Position NMEA sentences from the talkers GP, GL GN (and GA) are prioritized.</p> <p>Position source is selected by the quality indicator:</p> <ol style="list-style-type: none"> <li>1. Differential</li> <li>2. Precise, Autonomous, Float_RTK, Realtime_RTK</li> <li>3. Estimated and Manuel</li> <li>4. Unknown (for instance if not supported in sentence)</li> <li>5. Simulated and Invalid</li> </ol> <p>The device will automatically switch to the position source with the highest priority available after 5 seconds when switching to a lower priority input and 30 seconds when switching to a detected higher priority input.</p>



## Replacing the fuse in the power connector

One fuse is installed in the power connector. If the fuse is blown, do as follows:

1. Track down why the fuse was blown and solve the problem.
2. Take out the old fuse.
3. Insert the new fuse. The fuse rating is 10 A T.



Figure 4: Replacing the fuse in the power connector

## Replacing the fuse in the SAILOR 6090 Power Converter

One fuse is installed in the SAILOR 6090 Power Converter. If the fuse is blown, do as follows:

1. Track down why the fuse was blown and solve the problem.
2. Take out the old fuse.
3. Insert the new fuse. The fuse rating is 10 A T.



Figure 5: Replacing the fuse in the Power Converter

## Warranty and returning units for repair

Should your Cobham SATCOM product fail, please contact your dealer or installer, or the nearest Cobham SATCOM partner. You will find the partner details on [www.cobham.com/satcom](http://www.cobham.com/satcom), **Technical Service Partner List**. You can also access the Partner Portal at [www.cobham.com/satcom](http://www.cobham.com/satcom), **Cobham SYNC Partner Portal**, which may help you solve the problem. Your dealer, installer or Cobham SATCOM partner will assist you whether the need is user training, technical support, arranging on-site repair or sending the product for repair. Your dealer, installer or Cobham SATCOM partner will also take care of any warranty issue.

### Repacking for shipment

Should you need to send the product for repair, please read the below information before packing the product.

The shipping carton has been carefully designed to protect the SAILOR 6222 VHF DSC and its accessories during shipment. This carton and its associated packing material should be used when repacking for shipment. Attach a tag indicating the type of service required, return address, part number and full serial number. Mark the carton FRAGILE to ensure careful handling.

**Note**

Correct shipment is the customer's own responsibility.

If the original shipping carton is not available, the following general instructions should be used for repacking with commercially available material.

1. Wrap the defective unit in heavy paper or plastic. Attach a tag indicating the type of service required, return address, part number and full serial number.
2. Use a strong shipping container, e.g. a double walled carton.
3. Protect the front- and rear panel with cardboard and insert a layer of shock-absorbing material between all surfaces of the equipment and the sides of the container.
4. Seal the shipping container securely.

5. Mark the shipping container FRAGILE to ensure careful handling.  
Failure to do so may invalidate the warranty.

# Specifications

## Transceiver unit SAILOR 6222 VHF DSC

Item	Specification
Weight SAILOR 6222 VHF DSC	< 1.50 kg (3.3 lbs) approximately
Box weight SAILOR 6222 VHF DSC	3.8 kg (8.4 lbs) approximately, including SAILOR 6201 Handset with cradle, and wall mount cradle, SAILOR 6204 Control Speaker Microphone and Installation and user manual in box.
Dimensions	<p><b>Height:</b> Outer dimension 107 mm, hole height for flush mount 89 mm</p> <p><b>Width:</b> Outer dimension 241 mm, hole width for flush mount 227 mm</p> <p><b>Depth:</b> Outer dimension from front of knobs 132 mm, depth for flush mount 94 mm</p>
Operating temperature	-25°C to 55°C (5°F to 131°F)
Storage temperature	-30°C to 80°C (-22°F to 176°F)
Power supply	12 VDC Nominal (10,8– 15,6 VDC)
Current consumption	Max. 7 A
Current consumption at 12 VDC (no accessories connected)	RX: 0.5 A TX: 5 A
Current consumption at 12 VDC (all accessories connected)	RX: 0.7 A TX: 7 A

Item	Specification
Frequency range	TX: 156,000 MHz — 157,425 MHz, RX: 156,000 MHz — 163.425 MHz
Channel spacing	12.5 kHz and 25 kHz, all international maritime channels
Number of P channels	The radio may be programmed with up to 100 private channels in all channel modes.
Modulation 25 kHz 12.5 kHz	16K0G3E, 16K0G2B (DSC) 10K0G3E
Antenna	50 Ohm antenna, 50 Ohm female SO239 for PL259 plug 2-antenna operation for VHF and DSC communication
Water ingress	IPx8 and IPx6 all over. For flush-mount installations a sealing gasket is included in the delivery.
<b>Transmitter</b>	
Transmit power	Hi/Lo: 25 W and 1 W
RF output power	High: 25 W +0 dB / - 1.5 dB Low: 1 W +0 dB / - 1.5 dB
RF output power, Canada	High: 21 W ±0.75 dB Low: 0.8 W ±0.75 dB
Frequency error	Below 500 Hz
Adjacent channel power	Below 75 dB
Conducted spurious emission	Below 0.25 µW
Distortion	Below 3%
S/N ratio	Better than 46 dB

Item	Specification
<b>Receiver</b>	
Sensitivity	< -119 dBm typically @ 20 dB SINAD CCITT weighted
LF power	Built-in loudspeaker: 6 W (at 5 kHz dev./1 kHz tone). External loudspeaker: 6 W / 8 Ohm
Distortion	Below 5%
S/N ratio	Better than 43 dB
Spurious emissions	Below 2 nW
Spurious response rejection	More than 74 dB
Intermodulation response	More than 73 dB
Co-channel rejection	Better than —10 dB
Adjacent channel selectivity	More than 74 dB
Blocking level	More than 94 dB $\mu$ V

## General DSC specifications

Item	Description
DSC operation	According to Rec. ITU-R M.541-10 and Rec. ITU-R M.689-2, EN 300338-2
DSC protocol	According to Rec. ITU-R M.493-14 - Class A
Navigator interface	According to IEC 61162-1 GLL, RMC, ZDA, GGA, VTG, GNS
Symbol error rate	Below $1 \times 10^{-2}$ —113 dBm or 0.20 $\mu$ V p.d.
Modulation	1700 Hz $\pm$ 400 Hz. 1200 baud

Item	Description
Frequency error	Below $\pm 1$ Hz
Residual modulation	Below $-26$ dB

## NMEA data rates and formats

Item	Value
61162-1	4800,8,n,1
	Position over LAN

## SAILOR 6090 Power Converter 24—12 V

Item	Description
Weight	300 g
Dimensions	Height: 33 mm Width: 190 mm Depth: 85 mm
Operating temperature	$-25^{\circ}\text{C}$ to $55^{\circ}\text{C}$ ( $5^{\circ}\text{F}$ to $131^{\circ}\text{F}$ )
Storage temperature	$-30^{\circ}\text{C}$ to $80^{\circ}\text{C}$ ( $-22^{\circ}\text{F}$ to $176^{\circ}\text{F}$ )
Input voltage	21—32 VDC
Output voltage	12.5 VDC
Output current (max.)	8 A



# Maritime channels

## International channels (INT)

Channels	TX MHz	RX MHz	SIMPLEX		DUPLEX	
			Intership	Port	Port	Public
1	156,050	160,650			●	●
2	156,100	160,700			●	●
3	156,150	160,750			●	●
4	156,200	160,800			●	●
5	156,250	160,850			●	●
6	156,300	156,300	●			
7	156,350	160,950			●	●
8	156,400	156,400	●			
9	156,450	156,450	●	●		
10	156,500	156,500	●	●		
11	156,550	156,550		●		
12	156,600	156,600		●		
13	156,650	156,650	●	●		
14	156,700	156,700		●		
15	156,750	156,750		●		
16	156,800	156,800		●		
17	156,850	156,850	●	●		
18	156,900	161,500			●	●
19	156,950	161,550			●	●
1019 ***)	156,950	156,950				
2019 ***)	157,000	161,550		● (RX)		
20	157,000	161,600			●	●
1020 ***)	157,000	157,000		●		
2020 ***)		161,600		● (RX)		
21 **)	157,050	161,650				
22 **)	157,100	161,700				
23 **)	157,150	161,750				
24 **)	157,200	161,800				
25 **)	157,250	161,850				
26 **)	157,300	161,900				
27	157,350	161,950			●	●
1027 ***)	157,350	157,350		●		
28	157,400	162,000			●	●
1028 ***)	157,400	157,400		●		

Channels	TX MHz	RX MHz	SIMPLEX		DUPLEX	
			Intership	Port	Port	Public
60	156,025	160,625			●	●
61	156,075	160,675			●	●
62	156,125	160,725			●	●
63	156,175	160,775			●	●
64	156,225	160,825			●	●
65	156,275	160,875			●	●
66	156,325	160,925			●	●
67	156,375	156,375	●	●		
68	156,425	156,425		●		
69	156,475	156,475	●	●		
70	156,525	156,525	DSC	DSC		
71	156,575	156,575		●		
72	156,625	156,625	●	●		
73	156,675	156,675	●	●		
74	156,725	156,725		●		
75	156,775	156,775		● (L)		
76	156,825	156,825		● (L)		
77	156,875	156,875	●	●		
78	156,925	161,525			●	●
1078 ***)	156,925	156,925				
2078 ***)		161,525		● (RX)		
79	156,975	161,575			●	●
1079 ***)	156,975	156,975		●		
2079 ***)		161,575		● (RX)		
80 **)	157,025	161,625				
81 **)	157,075	161,675				
82 **)	157,125	161,725				
83 **)	157,175	161,775				
84 **)	157,225	161,825				
85 **)	157,275	161,875				
86 **)	157,325	161,925				
87	157,375	157,375		● *)		
88	157,425	157,425		● *)		

L) 1 W TX power

RX) Only RX: Transmission is blocked.

\*) Channel 87 and 88 became simplex channels following the introduction of AIS1 at 161.975 MHz and AIS2 on 162.025 MHz.

\*\*\*) According to Radio Regulations Final Acts WRC-15 Appendix 18 these channels are repurposed and must be default disabled as of January 1st 2017.

\*\*\*\*) According to Radio Regulations Final Acts WRC-15 Appendix 18 these channels must be default enabled as of January 1st 2017.

These are the default channels. Additional narrowband channels can be enabled, see *Channel setup* on page 41

# US channels

Channels	TX MHz	RX MHz	SIMPLEX	DUPLEX
1A	156,050	156,050	●	
2				B)
3				B)
4				B)
5A	156,250	156,250	●	
6	156,300	156,300	●	
7A	156,350	156,350	●	
8	156,400	156,400	●	
9	156,450	156,450	●	
10	156,500	156,500	●	
11	156,550	156,550	●	
12	156,600	156,600	●	
13	156,650	156,650	● L)	
14	156,700	156,700	●	
15		156,750	● RX)	
16	156,800	156,800	Distress and calling	
17	156,850	156,850	●	
18A	156,900	156,900	●	
19A	156,950	156,950	●	
20	157,000	161,600		●
20A	157,000	157,000	●	
21A	157,050	157,050	● I)	
22A	157,100	157,100	● I)	
23A	157,150	157,150	● I)	
24	157,200	161,800		●
25	157,250	161,850		●
26	157,300	161,900		●
27	157,350	161,950		●
28	157,400	162,000		●

Channels	TX MHz	RX MHz	SIMPLEX	DUPLEX
60				B)
61				B)
62				B)
63A	156,175	156,175	●	
64				B)
65A	156,275	156,275	●	
66A	156,325	156,325	●	
67	156,375	156,375	● L)	
68	156,425	156,425	●	
69	156,475	156,475	●	
70	156,525	156,525	DSC	
71	156,575	156,575	● L)	
72	156,625	156,625	●	
73	156,675	156,675	●	
74	156,725	156,725	●	
75				B)
76				B)
77	156,875	156,875	●	
78A	156,925	156,925	●	
79A	156,975	156,975	●	
80A	157,025	157,025	●	
81A	157,075	157,075	● I)	
82A	157,125	157,125	● I)	
83A	157,175	157,175	● I)	
84	157,225	161,825		●
85	157,275	161,875		●
86	157,325	161,925		●
87A	157,375	157,375	● *)	
88A	157,425	157,425	● *)	

Channels	RX MHz
W1	162,550
W2	162,400
W3	162,475
W4	162,425
W5	162,450
W6	162,500
W7	162,525

- L) 1 W TX power. Channels 13, 67 and 71 are limited to low transmission power.
- B) Channels 2, 3, 4, 60, 61, 62, 64, 75 and 76 cannot be selected in US mode.
- I) Channels 21A, 22A, 23A, 81A, 82A and 83A may be legally used in some circumstances but not by the general public in US waters.
- RX) Only RX: transmissions are blocked.
- \*) Channels 87 and 88 became simplex channels following the introduction of AIS1 at 161.975 MHz and AIS2 on 162.025 MHz.

These are the default channels. Additional narrowband channels can be enabled, see *Channel setup* on page 41.

## CA channels

Channels	TX MHz	RX MHz	SIMPLEX	DUPLEX
1	156,050	160,650		●
2	156,100	160,700		●
3	156,150	160,750		●
4A	156,200	156,200	● J)	
5A	156,250	156,250	●	
6	156,300	156,300	● J)	
7A	156,350	156,350	●	
8	156,400	156,400	●	
9	156,450	156,450	●	
10	156,500	156,500	●	
11	156,550	156,550	●	
12	156,600	156,600	●	
13	156,650	156,650	●	
14	156,700	156,700	●	
15	156,750	156,750	● L)	
16	156,800	156,800	Distress and calling	
17	156,850	156,850	● L)	
18A	156,900	156,900	●	
19A	156,950	156,950	● J)	
20	157,000	161,800		● L)
21A	157,050	157,050	● J)	
21B	161,850	161,850	● RX)	
22A	157,100	157,100	● J)	
23	157,150	161,750		●
24	157,200	161,800		●
25	157,250	161,850		●
26	157,300	161,900		●
27	157,350	161,950		●
28	157,400	162,000		●

Channels	TX MHz	RX MHz	SIMPLEX	DUPLEX
60	156,025	160,625		●
61A	156,075	156,075	● J)	
62A	156,125	156,125	● J)	
63A	156,175	156,175	● J)	
64	156,225	160,825		●
64A	156,225	156,225	●	
65A	156,275	156,275	● L)	
66A	156,325	156,325	● L)	
67	156,375	156,375	● J)	
68	156,425	156,425	●	
69	156,475	156,475	●	
70	156,525	156,525	DSC	
71	156,575	156,575	●	
72	156,625	156,625	● J)	
73	156,675	156,675	● J)	
74	156,725	156,725	●	
75	156,775	156,775	● L)	
76	156,825	156,825	● L)	
77	156,875	156,875	● L)	
78A	156,925	156,925	●	
79A	156,975	156,975	●	
80A	157,025	157,025	●	
81A	157,075	157,075	● J)	
82A	157,125	157,125	● J)	
83A	157,175	157,175	● J)	
83B		161,775	● RX)	
84	157,225	161,825		●
85	157,275	161,875		●
86	157,325	161,925		●
87	157,375	157,375	● *)	
88	157,425	157,425	● *)	

Channels	RX MHz
W1	162,550
W2	162,400
W3	162,475
W4	162,425
W5	162,450
W6	162,500
W7	162,525

- L) 1 W TX power. Channels 15, 17, 20, 65, 66, 75, 76 and 77 are limited to 1 W transmission power.
- J) Channels 4A, 6, 19A, 21A, 22A, 61A, 62A, 63A, 67, 72, 73, 81A, 82A and 83A may be legally used in some circumstances but not by the general public in CA waters.
- RX) Only RX: transmission is blocked.
- \*) Channels 87 and 88 became simplex channels following the introduction of AIS1 at 161.975 MHz and AIS2 on 162.025 MHz.

These are the default channels. Additional narrowband channels can be enabled, see *Channel setup* on page 41.

# BI channels

Channels	TX MHz	RX MHz	SIMPLEX		DUPLEX	
			Intership	Port	Port	Public
1	156,050	160,650			●	●
2	156,100	160,700			●	●
3	156,150	160,750			●	●
4	156,200	160,800			●	●
5	156,250	160,850			●	●
6	156,300	156,300	● L)			
7	156,350	160,950			●	●
8	156,400	156,400	● L)			
9	156,450	156,450	●	●		
10	156,500	156,500	● L)	● L)		
11	156,550	156,550		● L)		
12	156,600	156,600		● L)		
13	156,650	156,650	● L)	● L)		
14	156,700	156,700		● L)		
15	156,750	156,750	● L)	● L)		
16	156,800	156,800	Distress and calling			
17	156,850	156,850	● L)	● L)		
18	156,900	161,500			●	●
19	156,950	161,550			●	●
1019 ***	156,950	156,950				
2019 ***		161,550		●RX)		
20	157,000	161,600			●	●
1020 ***	157,000	157,000		●		
2020 ***		161,600		●RX)		
21 **	157,050	161,650				
22 **	157,100	161,700				
23 **	157,150	161,750				
24 **	157,200	161,800				
25 **	157,250	161,850				
26 **	157,300	161,900				
27	157,350	161,950			●	●
1027 ***	157,350	157,350		●		
28	157,400	162,000			●	●
1028 ***	157,400	157,400		●		

Channels	TX MHz	RX MHz	SIMPLEX		DUPLEX	
			Intership	Port	Port	Public
60	156,025	160,625			●	●
61	156,075	160,675			●	●
62	156,125	160,725			●	●
63	156,175	160,775			●	●
64	156,225	160,825			●	●
65	156,275	160,875			●	●
66	156,325	160,925			●	●
67	156,375	156,375	●	●		
68	156,425	156,425		●		
69	156,475	156,475	●	●		
70	156,525	156,525		DSC	DSC	
71	156,575	156,575		● L)		
72	156,625	156,625	● L)			
73	156,675	156,675	●	●		
74	156,725	156,725		● L)		
75	156,775	156,775		● L)		
76	156,825	156,825		● L)		
77	156,875	156,875	● L)			
78	156,925	161,525			●	●
1078 ***	156,925	156,925		●		
2078 ***		161,525		●RX)		
79	156,975	161,575			●	●
1079 ***	156,975	156,975		●		
2079 ***		161,575		●RX)		
80 **	157,025	161,625				
81 **	157,075	161,675				
82 **	157,125	161,725				
83 **	157,175	161,775				
84 **	157,225	161,825				
85 **	157,275	161,875				
86 **	157,325	161,925				
87	157,375	157,375		● *)		
88	157,425	157,425		● *)		

- L) 1 W TX power on channels 6, 8, 10, 11, 12, 13, 14, 15, 17, 71, 72, 74, 75, 76 and 77.
- RX) Only RX) Transmission is blocked.
- \*) Channels 87 and 88 became simplex channels following the introduction of AIS1 at 161.975 MHz and AIS2 on 162.025 MHz.
- \*\*\*) According to Radio Regulations Final Acts WRC-15 Appendix 18 these channels are repurposed and must be default disabled as of January 1st 2017.
- \*\*) According to Radio Regulations Final Acts WRC-15 Appendix 18 these channels must be default enabled as of January 1st 2017.
- NB! The ATIS function is enabled on all channels.  
Dual Watch & Scanning modes are disabled.

## Alternative channels

If the radio is used in regions where neither of the four described standard channels are allowed, a reduced channel table with international channel

designators and frequencies can be made. Contact your local dealer for programming the alternative channels.

## **Private channels**

Up to 100 licensed private channels for non-DSC purposes may be specified. For programming the private channels contact your local dealer.



## A

**AIS** Automatic Identification System, a short range coastal tracking system used on ships and by Vessel Traffic Services for identifying and locating vessels by electronically exchanging data with other nearby ships.

**ATIS** Automatic Transmission Identification System

## D

**DROBOS** Distress Relay On Behalf Of Someone else

**DSC** Digital Selective Calling

## E

**EPIRB** Emergency Position-Indicating Radio Beacon. Distress radio beacons, also known as emergency beacons are tracking transmitters which aid in the detection and location of boats, aircraft, and people in distress.

## G

**GPL** General Public License

**GPS** Global Positioning System

## L

**LAN** Local Area Network ,

**LGPL** Lesser General Public License

**LWE** Light Weight Ethernet

**LWE** Light Weight Ethernet UDP Broadcast

## M

**MMSI** Maritime Mobile Service Identity. A series of nine digits which are sent in digital form over a radio frequency channel in order to uniquely identify ship stations, ship earth stations, coast stations, coast earth stations, and group calls. These identities are formed in such a way that the identity or part thereof can be used by telephone and telex subscribers connected to the general telecommunications network to call ships automatically.

**MOB** Man Over Board

## P

**PTT** Push To Talk

## S

**SLP** Service Location Protocol

## T

**TU** Transceiver Unit

## U

**UTC** Coordinated Universal Time. The International Atomic Time (TAI) with leap seconds added at irregular intervals to compensate for the Earth's slowing rotation. Leap seconds are used to allow UTC to closely track UT1, which is mean solar time at the Royal Observatory, Greenwich.

## V

**VDR** Voyage Data Recorder, a data recording system designed for all vessels required to comply with the IMO's International Convention SOLAS Requirements in order to collect data from various sensors on board the vessel.



VHF                  Very High Frequency



## Numerics

16/C, 10, 15

## A

acknowledgement, distress, 23

action line, display, 3

activate

scan resume, 39

scanning, 20

watch, 19

ADD, 36

add a contact, 36

adjust

speaker volume, 10

squelch, 14

Alarm Panel

manual, x

alarm panel

Distress, 24

ALERT, 22

ALT, 71

ALT channel table, 41

ATIS code, 40

change, 47

attenuation control, 18

Auto-Ack

Individual, 43

Polling, 43

Position, 43

Test, 43

## B

background sessions

DSC, 34

backlight, 1

dim, 10

bandwidth, 41

Bi, 70

Bi channels, 70

browse channels, 10

## C

CA channel table, 41

CA channels, 69

CALL, 35

call

Distress procedure, vi

DSC, 21

call channel, 17

programming, 41

call log, DSC, 44

cancelling

distress, 23

change

dual and triple watch, 19

channel

add to scan, 20

bandwidth, 41

remove from scan, 20

select, 10, 11

working, 10, 11

channel table

ALT, 41, 71

Bi, 70

CA, 41, 69

INT, 67

PRIV, 41

US, 41, 68

### channels

- Bi, 70
  - CA, 69
  - international, 67
  - primary, 17
  - private, 17
  - US, 68
  - weather, 17
- Colour theme, 45
- Comm Inactivity, 43
- configuration
  - system example, 7
- contact, 51
  - adding, 36
  - deleting, 37
  - editing, 37
- control over radio transmitter, 29
- Control Speaker Microphone
  - override, 14
- controls, front plate, 2
- cradle for 6201, installation, 4

## D

### data rate

- NMEA, 66
- deactivate
  - watch, 19
- default reset, 47
- DELETE, 37
- delete contact, 37
- dim, 10
- display, 3
- display colour
  - change, 45

### distress

- acknowledgement, 23
  - cancelling, 23
  - display, 22
  - message relay, 25
  - nature, 22
  - power failure, 24
  - received calls, 26
  - send from alarm panel, 24
  - time since activation, 22
- distress alert, 22
- distress button, 21
- distress channel, 10, 15
- Distress procedure, vi
- Distress timeout, 43
- document number, this manual, i
- DROBOS, 13, 25
- DSC
  - background sessions, 34
  - call log, 27, 44
  - calls, 21
  - loopback test, 52
  - multiple calls, 34
  - session definition, 29
- DSC alarms
  - non distress, 43
- DSC call logs
  - setup, 44
- DSC self test, 44
- DSC session, 29
  - typical display, 29
- DSC soft keys, 31
- DSC window, 29
- dual watch, 40
  - change to triple, 19

**E**

editing a contact, 37  
Emergency call sheet, x  
emergency calls, vi  
engagement status, 18  
enter position manually, 12  
EPIRB  
    nature in DROBOS, 25  
error messages, 51

**F**

factory defaults, 47  
FILTER, 20  
frequency range, VHF, 64  
front plate, controls, 2  
fuse  
    Power Converter, 60  
    VHF radio, 59

**G**

GPS data, 12  
GPS position  
    display, 12

**H**

Hand Microphone, 11  
handset cradle  
    installation, 4  
hang time, 39  
how to replace, 30

**I**

icons  
    session state, 29  
installation  
    cradle for 6201, 4  
    handset cradle, 4  
installation guide, A3, x  
installation manual, x  
    Alarm Panel, x  
INT, 67  
IP address, 47  
IP rating, 64

**K**

key 16/C, 10, 15  
keys on front plate, 2  
knob  
    selector, 2  
    volume, 2

**L**

LOCAL, 18  
louder, volume, 10  
low power  
    override, 18  
    set to 1 W, 18

**M**

manual, document number, i  
maritime channels, 67  
MAYDAY, vi  
medical transport, 43

- menu, overview, 48
- message
  - replay, 38
- MMSI
  - change, 47
  - wrong number in the radio, 56
- monitor power supply, 42
- MORE, 13
- multiple calls, DSC, 34
- mute speaker, 14

## N

- narrow band, 41
- nature of distress, 22
- neutral crafts, 43
- night vision, how to dim, 10
- NMEA
  - data rate, 66
- Non-dist Inactivity, 43
- Non-distr.alarms, 43

## O

- Occupied, 14
- override
  - Control Speaker Microphone, 14
- overriding low power, 18

## P

- password, 47
- PHBOOK, 35
- phone book, 35
  - add contact, 36
  - delete a contact, 37
  - edit a contact, 37

- position
  - enter manually, 12
- position data
  - enter manually, 42
- position Info, 42
- power
  - fuse, 59
  - off, 10
  - on, 10
- Power Converter
  - fuse, 60
- power failure
  - distress, 24
- power supply
  - monitor, 42
- Print DSC, 44
- priority scan, 40
- PRIV
  - channel table, 41
- private channels, 17, 64, 71
- PTT button, 15

## R

- radio call
  - making, 16
  - receiving, 15
- radio transmitter
  - control, 34
  - control over, 29
- received distress calls, 26
- reduced transmission power, 18
- relay
  - distress message on behalf of someone else, 25
- remote control, 14
- replay, 1, 38
  - button, 2
- reset to default, 47

resume time, 39  
RF exposure hazards, iv  
run  
    DSC self test, 44

## S

safety summary, iv  
salt deposits, 51  
scan  
    add channel, 20  
    hang time, 39  
    priority, 40  
    remove channel, 20  
    resume time, 39  
    resume, activate, 39  
    start, 20  
selector knob, 2, 10  
self test, 52  
    DSC, 44  
semi duplex, 1  
serial number, 47  
service line, display, 3  
session  
    INFO key, 32  
    line, 30  
    soft keys, 31  
    state icons, 29  
    status, 30  
    what is, 29  
setup  
    controller, 47  
    DSC call logs, 44  
    overview, 48  
    parameters, 48  
    Radio, 39  
    system, 44  
    watch, 39

simplex, 1  
soft key, 13  
    ADD, 36  
    ALERT, 22  
    CALL, 35  
    DELETE, 37  
    DISACK, 26  
    DROBOS, 13, 25  
    DSC, 31  
    FILTER, 20  
    LOCAL, 18  
    MORE, 13  
    OVERRIDE, 18  
    PHBOOK, 35  
    RELAY, 25  
    STOP, 38  
    TAG, 20  
    WATCH, 19  
softer, volume, 10  
Software version, 47  
speaker volume, 10  
speaking devices, 11  
specifications, 63  
squelch, 14  
squelch control, 2, 14  
STOP, 38  
stop  
    replaying a message, 38  
    watch or scan, 19, 20  
support, 51  
system configuration  
    example, 7  
system setup, 44

## T

TAG, 20  
    remove, 20

- tagged channels
  - view, 20
- technical data, 63
- temperature
  - operational, 63, 66
  - storage, 63, 66
- theme
  - colour, change, 45
- timeout, 45
  - Distress, 43
  - non distress, 43
  - VHF and other non distress, 43
- triple watch, 40
  - change to dual, 19
- warranty, 61
  - limitation, iv
- WATCH, 19, 20
- watch
  - dual and triple, 19
  - dual or triple, 40
  - setup, 39
  - start, 19
  - stop, 19
- water ingress, 64
- weather channels, 17
- weight, 63, 66
- wide band, 41
- working channel, 10, 11

## U

- US, 68
- US channel table, 41, 68
- Use GPS, 12
- UTC time, 3
  - enter manually, 12

## V

- VHF
  - channels, 16
  - frequency range, 64
- volume
  - louder, 10
  - softer, 10
  - speaker, 10
- Volume knob, 2

## W

- warnings, 51





