

R&S® SMB100A

RF and Microwave Signal Generator

Operating Manual



1407.0806.32 – 21

This document describes the R&S®SMB100A, stock no. 1406.6000K02/K03 and its options.

- R&S®SMB-B1/-B1H
- R&S®SMB-B5
- R&S®SMB-B25/-B26
- R&S®SMB-B30/-B31/-B32
- R&S®SMB-B101/-B102/-B103/-B106
- R&S®SMB-B112/-B112L/-B120/-B120L
- R&S®SMB-B131
- R&S®SMB-B140/-B140L/-B140N
- R&S®SMB-K21/-K22
- R&S®SMB-K23/-K27

© 2016 Rohde & Schwarz GmbH & Co. KG

Mühlhofstr. 15, 81671 München, Germany

Phone: +49 89 41 29 - 0

Fax: +49 89 41 29 12 164

Email: info@rohde-schwarz.com

Internet: www.rohde-schwarz.com

Subject to change – Data without tolerance limits is not binding.

R&S® is a registered trademark of Rohde & Schwarz GmbH & Co. KG.

Trade names are trademarks of the owners.

The following abbreviations are used throughout this manual: R&S®SMB100A is abbreviated as R&S SMB, the R&S®SMZ75/90/110/170 is abbreviated as R&S®SMZ, Linux® is abbreviated as Linux.

Basic Safety Instructions

Always read through and comply with the following safety instructions!

All plants and locations of the Rohde & Schwarz group of companies make every effort to keep the safety standards of our products up to date and to offer our customers the highest possible degree of safety. Our products and the auxiliary equipment they require are designed, built and tested in accordance with the safety standards that apply in each case. Compliance with these standards is continuously monitored by our quality assurance system. The product described here has been designed, built and tested in accordance with the EC Certificate of Conformity and has left the manufacturer's plant in a condition fully complying with safety standards. To maintain this condition and to ensure safe operation, you must observe all instructions and warnings provided in this manual. If you have any questions regarding these safety instructions, the Rohde & Schwarz group of companies will be happy to answer them.

Furthermore, it is your responsibility to use the product in an appropriate manner. This product is designed for use solely in industrial and laboratory environments or, if expressly permitted, also in the field and must not be used in any way that may cause personal injury or property damage. You are responsible if the product is used for any purpose other than its designated purpose or in disregard of the manufacturer's instructions. The manufacturer shall assume no responsibility for such use of the product.

The product is used for its designated purpose if it is used in accordance with its product documentation and within its performance limits (see data sheet, documentation, the following safety instructions). Using the product requires technical skills and, in some cases, a basic knowledge of English. It is therefore essential that only skilled and specialized staff or thoroughly trained personnel with the required skills be allowed to use the product. If personal safety gear is required for using Rohde & Schwarz products, this will be indicated at the appropriate place in the product documentation. Keep the basic safety instructions and the product documentation in a safe place and pass them on to the subsequent users.

Observing the safety instructions will help prevent personal injury or damage of any kind caused by dangerous situations. Therefore, carefully read through and adhere to the following safety instructions before and when using the product. It is also absolutely essential to observe the additional safety instructions on personal safety, for example, that appear in relevant parts of the product documentation. In these safety instructions, the word "product" refers to all merchandise sold and distributed by the Rohde & Schwarz group of companies, including instruments, systems and all accessories. For product-specific information, see the data sheet and the product documentation.

Safety labels on products

The following safety labels are used on products to warn against risks and dangers.





Symbol	Meaning	Symbol	Meaning
	Notice, general danger location Observe product documentation		ON/OFF Power
	Caution when handling heavy equipment		Standby indication
	Danger of electric shock		Direct current (DC)

Basic Safety Instructions

Symbol	Meaning	Symbol	Meaning
	Caution ! Hot surface		Alternating current (AC)
	Protective conductor terminal To identify any terminal which is intended for connection to an external conductor for protection against electric shock in case of a fault, or the terminal of a protective earth		Direct/alternating current (DC/AC)
	Earth (Ground)		Class II Equipment to identify equipment meeting the safety requirements specified for Class II equipment (device protected by double or reinforced insulation)
	Frame or chassis Ground terminal		EU labeling for batteries and accumulators For additional information, see section "Waste disposal/Environmental protection", item 1.
	Be careful when handling electrostatic sensitive devices		EU labeling for separate collection of electrical and electronic devices For additional information, see section "Waste disposal/Environmental protection", item 2.
	Warning! Laser radiation For additional information, see section "Operation", item 7.		

Signal words and their meaning

The following signal words are used in the product documentation in order to warn the reader about risks and dangers.

	Indicates a hazardous situation which, if not avoided, will result in death or serious injury.
	Indicates a hazardous situation which, if not avoided, could result in death or serious injury.
	Indicates a hazardous situation which, if not avoided, could result in minor or moderate injury.
	Indicates information considered important, but not hazard-related, e.g. messages relating to property damage. In the product documentation, the word ATTENTION is used synonymously.

These signal words are in accordance with the standard definition for civil applications in the European Economic Area. Definitions that deviate from the standard definition may also exist in other economic areas or military applications. It is therefore essential to make sure that the signal words described here are always used only in connection with the related product documentation and the related product. The use of signal words in connection with unrelated products or documentation can result in misinterpretation and in personal injury or material damage.

Basic Safety Instructions

Operating states and operating positions

The product may be operated only under the operating conditions and in the positions specified by the manufacturer, without the product's ventilation being obstructed. If the manufacturer's specifications are not observed, this can result in electric shock, fire and/or serious personal injury or death. Applicable local or national safety regulations and rules for the prevention of accidents must be observed in all work performed.

1. Unless otherwise specified, the following requirements apply to Rohde & Schwarz products: predefined operating position is always with the housing floor facing down, IP protection 2X, use only indoors, max. operating altitude 2000 m above sea level, max. transport altitude 4500 m above sea level. A tolerance of $\pm 10\%$ shall apply to the nominal voltage and $\pm 5\%$ to the nominal frequency, overvoltage category 2, pollution degree 2.
2. Do not place the product on surfaces, vehicles, cabinets or tables that for reasons of weight or stability are unsuitable for this purpose. Always follow the manufacturer's installation instructions when installing the product and fastening it to objects or structures (e.g. walls and shelves). An installation that is not carried out as described in the product documentation could result in personal injury or even death.
3. Do not place the product on heat-generating devices such as radiators or fan heaters. The ambient temperature must not exceed the maximum temperature specified in the product documentation or in the data sheet. Product overheating can cause electric shock, fire and/or serious personal injury or even death.

Electrical safety

If the information on electrical safety is not observed either at all or to the extent necessary, electric shock, fire and/or serious personal injury or death may occur.

1. Prior to switching on the product, always ensure that the nominal voltage setting on the product matches the nominal voltage of the mains-supply network. If a different voltage is to be set, the power fuse of the product may have to be changed accordingly.
2. In the case of products of safety class I with movable power cord and connector, operation is permitted only on sockets with a protective conductor contact and protective conductor.
3. Intentionally breaking the protective conductor either in the feed line or in the product itself is not permitted. Doing so can result in the danger of an electric shock from the product. If extension cords or connector strips are implemented, they must be checked on a regular basis to ensure that they are safe to use.
4. If there is no power switch for disconnecting the product from the mains, or if the power switch is not suitable for this purpose, use the plug of the connecting cable to disconnect the product from the mains. In such cases, always ensure that the power plug is easily reachable and accessible at all times. For example, if the power plug is the disconnecting device, the length of the connecting cable must not exceed 3 m. Functional or electronic switches are not suitable for providing disconnection from the AC supply network. If products without power switches are integrated into racks or systems, the disconnecting device must be provided at the system level.
5. Never use the product if the power cable is damaged. Check the power cables on a regular basis to ensure that they are in proper operating condition. By taking appropriate safety measures and carefully laying the power cable, ensure that the cable cannot be damaged and that no one can be hurt by, for example, tripping over the cable or suffering an electric shock.

Basic Safety Instructions

6. The product may be operated only from TN/TT supply networks fuse-protected with max. 16 A (higher fuse only after consulting with the Rohde & Schwarz group of companies).
7. Do not insert the plug into sockets that are dusty or dirty. Insert the plug firmly and all the way into the socket provided for this purpose. Otherwise, sparks that result in fire and/or injuries may occur.
8. Do not overload any sockets, extension cords or connector strips; doing so can cause fire or electric shocks.
9. For measurements in circuits with voltages $V_{rms} > 30$ V, suitable measures (e.g. appropriate measuring equipment, fuse protection, current limiting, electrical separation, insulation) should be taken to avoid any hazards.
10. Ensure that the connections with information technology equipment, e.g. PCs or other industrial computers, comply with the IEC 60950-1 / EN 60950-1 or IEC 61010-1 / EN 61010-1 standards that apply in each case.
11. Unless expressly permitted, never remove the cover or any part of the housing while the product is in operation. Doing so will expose circuits and components and can lead to injuries, fire or damage to the product.
12. If a product is to be permanently installed, the connection between the protective conductor terminal on site and the product's protective conductor must be made first before any other connection is made. The product may be installed and connected only by a licensed electrician.
13. For permanently installed equipment without built-in fuses, circuit breakers or similar protective devices, the supply circuit must be fuse-protected in such a way that anyone who has access to the product, as well as the product itself, is adequately protected from injury or damage.
14. Use suitable overvoltage protection to ensure that no overvoltage (such as that caused by a bolt of lightning) can reach the product. Otherwise, the person operating the product will be exposed to the danger of an electric shock.
15. Any object that is not designed to be placed in the openings of the housing must not be used for this purpose. Doing so can cause short circuits inside the product and/or electric shocks, fire or injuries.
16. Unless specified otherwise, products are not liquid-proof (see also section "Operating states and operating positions", item 1). Therefore, the equipment must be protected against penetration by liquids. If the necessary precautions are not taken, the user may suffer electric shock or the product itself may be damaged, which can also lead to personal injury.
17. Never use the product under conditions in which condensation has formed or can form in or on the product, e.g. if the product has been moved from a cold to a warm environment. Penetration by water increases the risk of electric shock.
18. Prior to cleaning the product, disconnect it completely from the power supply (e.g. AC supply network or battery). Use a soft, non-linting cloth to clean the product. Never use chemical cleaning agents such as alcohol, acetone or diluents for cellulose lacquers.

Operation

1. Operating the products requires special training and intense concentration. Make sure that persons who use the products are physically, mentally and emotionally fit enough to do so; otherwise, injuries or material damage may occur. It is the responsibility of the employer/operator to select suitable personnel for operating the products.

Basic Safety Instructions

2. Before you move or transport the product, read and observe the section titled "Transport".
3. As with all industrially manufactured goods, the use of substances that induce an allergic reaction (allergens) such as nickel cannot be generally excluded. If you develop an allergic reaction (such as a skin rash, frequent sneezing, red eyes or respiratory difficulties) when using a Rohde & Schwarz product, consult a physician immediately to determine the cause and to prevent health problems or stress.
4. Before you start processing the product mechanically and/or thermally, or before you take it apart, be sure to read and pay special attention to the section titled "Waste disposal/Environmental protection", item 1.
5. Depending on the function, certain products such as RF radio equipment can produce an elevated level of electromagnetic radiation. Considering that unborn babies require increased protection, pregnant women must be protected by appropriate measures. Persons with pacemakers may also be exposed to risks from electromagnetic radiation. The employer/operator must evaluate workplaces where there is a special risk of exposure to radiation and, if necessary, take measures to avert the potential danger.
6. Should a fire occur, the product may release hazardous substances (gases, fluids, etc.) that can cause health problems. Therefore, suitable measures must be taken, e.g. protective masks and protective clothing must be worn.
7. Laser products are given warning labels that are standardized according to their laser class. Lasers can cause biological harm due to the properties of their radiation and due to their extremely concentrated electromagnetic power. If a laser product (e.g. a CD/DVD drive) is integrated into a Rohde & Schwarz product, absolutely no other settings or functions may be used as described in the product documentation. The objective is to prevent personal injury (e.g. due to laser beams).
8. EMC classes (in line with EN 55011/CISPR 11, and analogously with EN 55022/CISPR 22, EN 55032/CISPR 32)
 - Class A equipment:
Equipment suitable for use in all environments except residential environments and environments that are directly connected to a low-voltage supply network that supplies residential buildings
Note: Class A equipment is intended for use in an industrial environment. This equipment may cause radio disturbances in residential environments, due to possible conducted as well as radiated disturbances. In this case, the operator may be required to take appropriate measures to eliminate these disturbances.
 - Class B equipment:
Equipment suitable for use in residential environments and environments that are directly connected to a low-voltage supply network that supplies residential buildings

Repair and service

1. The product may be opened only by authorized, specially trained personnel. Before any work is performed on the product or before the product is opened, it must be disconnected from the AC supply network. Otherwise, personnel will be exposed to the risk of an electric shock.

Basic Safety Instructions

- Adjustments, replacement of parts, maintenance and repair may be performed only by electrical experts authorized by Rohde & Schwarz. Only original parts may be used for replacing parts relevant to safety (e.g. power switches, power transformers, fuses). A safety test must always be performed after parts relevant to safety have been replaced (visual inspection, protective conductor test, insulation resistance measurement, leakage current measurement, functional test). This helps ensure the continued safety of the product.

Batteries and rechargeable batteries/cells

If the information regarding batteries and rechargeable batteries/cells is not observed either at all or to the extent necessary, product users may be exposed to the risk of explosions, fire and/or serious personal injury, and, in some cases, death. Batteries and rechargeable batteries with alkaline electrolytes (e.g. lithium cells) must be handled in accordance with the EN 62133 standard.

- Cells must not be taken apart or crushed.
- Cells or batteries must not be exposed to heat or fire. Storage in direct sunlight must be avoided. Keep cells and batteries clean and dry. Clean soiled connectors using a dry, clean cloth.
- Cells or batteries must not be short-circuited. Cells or batteries must not be stored in a box or in a drawer where they can short-circuit each other, or where they can be short-circuited by other conductive materials. Cells and batteries must not be removed from their original packaging until they are ready to be used.
- Cells and batteries must not be exposed to any mechanical shocks that are stronger than permitted.
- If a cell develops a leak, the fluid must not be allowed to come into contact with the skin or eyes. If contact occurs, wash the affected area with plenty of water and seek medical aid.
- Improperly replacing or charging cells or batteries that contain alkaline electrolytes (e.g. lithium cells) can cause explosions. Replace cells or batteries only with the matching Rohde & Schwarz type (see parts list) in order to ensure the safety of the product.
- Cells and batteries must be recycled and kept separate from residual waste. Rechargeable batteries and normal batteries that contain lead, mercury or cadmium are hazardous waste. Observe the national regulations regarding waste disposal and recycling.

Transport

- The product may be very heavy. Therefore, the product must be handled with care. In some cases, the user may require a suitable means of lifting or moving the product (e.g. with a lift-truck) to avoid back or other physical injuries.
- Handles on the products are designed exclusively to enable personnel to transport the product. It is therefore not permissible to use handles to fasten the product to or on transport equipment such as cranes, fork lifts, wagons, etc. The user is responsible for securely fastening the products to or on the means of transport or lifting. Observe the safety regulations of the manufacturer of the means of transport or lifting. Noncompliance can result in personal injury or material damage.
- If you use the product in a vehicle, it is the sole responsibility of the driver to drive the vehicle safely and properly. The manufacturer assumes no responsibility for accidents or collisions. Never use the product in a moving vehicle if doing so could distract the driver of the vehicle. Adequately secure the product in the vehicle to prevent injuries or other damage in the event of an accident.

Instrucciones de seguridad elementales

Waste disposal/Environmental protection

1. Specially marked equipment has a battery or accumulator that must not be disposed of with unsorted municipal waste, but must be collected separately. It may only be disposed of at a suitable collection point or via a Rohde & Schwarz customer service center.
2. Waste electrical and electronic equipment must not be disposed of with unsorted municipal waste, but must be collected separately.
Rohde & Schwarz GmbH & Co. KG has developed a disposal concept and takes full responsibility for take-back obligations and disposal obligations for manufacturers within the EU. Contact your Rohde & Schwarz customer service center for environmentally responsible disposal of the product.
3. If products or their components are mechanically and/or thermally processed in a manner that goes beyond their intended use, hazardous substances (heavy-metal dust such as lead, beryllium, nickel) may be released. For this reason, the product may only be disassembled by specially trained personnel. Improper disassembly may be hazardous to your health. National waste disposal regulations must be observed.
4. If handling the product releases hazardous substances or fuels that must be disposed of in a special way, e.g. coolants or engine oils that must be replenished regularly, the safety instructions of the manufacturer of the hazardous substances or fuels and the applicable regional waste disposal regulations must be observed. Also observe the relevant safety instructions in the product documentation. The improper disposal of hazardous substances or fuels can cause health problems and lead to environmental damage.

For additional information about environmental protection, visit the Rohde & Schwarz website.

Instrucciones de seguridad elementales

¡Es imprescindible leer y cumplir las siguientes instrucciones e informaciones de seguridad!

El principio del grupo de empresas Rohde & Schwarz consiste en tener nuestros productos siempre al día con los estándares de seguridad y de ofrecer a nuestros clientes el máximo grado de seguridad. Nuestros productos y todos los equipos adicionales son siempre fabricados y examinados según las normas de seguridad vigentes. Nuestro sistema de garantía de calidad controla constantemente que sean cumplidas estas normas. El presente producto ha sido fabricado y examinado según el certificado de conformidad de la UE y ha salido de nuestra planta en estado impecable según los estándares técnicos de seguridad. Para poder preservar este estado y garantizar un funcionamiento libre de peligros, el usuario deberá atenerse a todas las indicaciones, informaciones de seguridad y notas de alerta. El grupo de empresas Rohde & Schwarz está siempre a su disposición en caso de que tengan preguntas referentes a estas informaciones de seguridad.

Además queda en la responsabilidad del usuario utilizar el producto en la forma debida. Este producto está destinado exclusivamente al uso en la industria y el laboratorio o, si ha sido expresamente autorizado, para aplicaciones de campo y de ninguna manera deberá ser utilizado de modo que alguna persona/cosa pueda sufrir daño. El uso del producto fuera de sus fines definidos o sin tener en cuenta las instrucciones del fabricante queda en la responsabilidad del usuario. El fabricante no se hace en ninguna forma responsable de consecuencias a causa del mal uso del producto.















Instrucciones de seguridad elementales

Se parte del uso correcto del producto para los fines definidos si el producto es utilizado conforme a las indicaciones de la correspondiente documentación del producto y dentro del margen de rendimiento definido (ver hoja de datos, documentación, informaciones de seguridad que siguen). El uso del producto hace necesarios conocimientos técnicos y ciertos conocimientos del idioma inglés. Por eso se debe tener en cuenta que el producto solo pueda ser operado por personal especializado o personas instruidas en profundidad con las capacidades correspondientes. Si fuera necesaria indumentaria de seguridad para el uso de productos de Rohde & Schwarz, encontraría la información debida en la documentación del producto en el capítulo correspondiente. Guarde bien las informaciones de seguridad elementales, así como la documentación del producto, y entréguelas a usuarios posteriores.

Tener en cuenta las informaciones de seguridad sirve para evitar en lo posible lesiones o daños por peligros de toda clase. Por eso es imprescindible leer detalladamente y comprender por completo las siguientes informaciones de seguridad antes de usar el producto, y respetarlas durante el uso del producto. Deberán tenerse en cuenta todas las demás informaciones de seguridad, como p. ej. las referentes a la protección de personas, que encontrarán en el capítulo correspondiente de la documentación del producto y que también son de obligado cumplimiento. En las presentes informaciones de seguridad se recogen todos los objetos que distribuye el grupo de empresas Rohde & Schwarz bajo la denominación de "producto", entre ellos también aparatos, instalaciones así como toda clase de accesorios. Los datos específicos del producto figuran en la hoja de datos y en la documentación del producto.

Señalización de seguridad de los productos

Las siguientes señales de seguridad se utilizan en los productos para advertir sobre riesgos y peligros.

Símbolo	Significado	Símbolo	Significado
	Aviso: punto de peligro general Observar la documentación del producto		Tensión de alimentación de PUESTA EN MARCHA / PARADA
	Atención en el manejo de dispositivos de peso elevado		Indicación de estado de espera (standby)
	Peligro de choque eléctrico		Corriente continua (DC)
	Advertencia: superficie caliente		Corriente alterna (AC)
	Conexión a conductor de protección		Corriente continua / Corriente alterna (DC/AC)
	Conexión a tierra		El aparato está protegido en su totalidad por un aislamiento doble (reforzado)
	Conexión a masa		Distintivo de la UE para baterías y acumuladores Más información en la sección "Eliminación/protección del medio ambiente", punto 1.

Instrucciones de seguridad elementales

Símbolo	Significado	Símbolo	Significado
	Aviso: Cuidado en el manejo de dispositivos sensibles a la electrostática (ESD)		Distintivo de la UE para la eliminación por separado de dispositivos eléctricos y electrónicos Más información en la sección "Eliminación/protección del medio ambiente", punto 2.
	Advertencia: rayo láser Más información en la sección "Funcionamiento", punto 7.		

Palabras de señal y su significado

En la documentación del producto se utilizan las siguientes palabras de señal con el fin de advertir contra riesgos y peligros.



Indica una situación de peligro que, si no se evita, causa lesiones graves o incluso la muerte.



Indica una situación de peligro que, si no se evita, puede causar lesiones graves o incluso la muerte.



Indica una situación de peligro que, si no se evita, puede causar lesiones leves o moderadas.



Indica información que se considera importante, pero no en relación con situaciones de peligro; p. ej., avisos sobre posibles daños materiales.

En la documentación del producto se emplea de forma sinónima el término CUIDADO.

Las palabras de señal corresponden a la definición habitual para aplicaciones civiles en el área económica europea. Pueden existir definiciones diferentes a esta definición en otras áreas económicas o en aplicaciones militares. Por eso se deberá tener en cuenta que las palabras de señal aquí descritas sean utilizadas siempre solamente en combinación con la correspondiente documentación del producto y solamente en combinación con el producto correspondiente. La utilización de las palabras de señal en combinación con productos o documentaciones que no les correspondan puede llevar a interpretaciones equivocadas y tener por consecuencia daños en personas u objetos.

Estados operativos y posiciones de funcionamiento

El producto solamente debe ser utilizado según lo indicado por el fabricante respecto a los estados operativos y posiciones de funcionamiento sin que se obstruya la ventilación. Si no se siguen las indicaciones del fabricante, pueden producirse choques eléctricos, incendios y/o lesiones graves con posible consecuencia de muerte. En todos los trabajos deberán ser tenidas en cuenta las normas nacionales y locales de seguridad del trabajo y de prevención de accidentes.

Instrucciones de seguridad elementales

1. Si no se convino de otra manera, es para los productos Rohde & Schwarz válido lo que sigue: como posición de funcionamiento se define por principio la posición con el suelo de la caja para abajo, modo de protección IP 2X, uso solamente en estancias interiores, utilización hasta 2000 m sobre el nivel del mar, transporte hasta 4500 m sobre el nivel del mar. Se aplicará una tolerancia de $\pm 10\%$ sobre el voltaje nominal y de $\pm 5\%$ sobre la frecuencia nominal. Categoría de sobrecarga eléctrica 2, índice de suciedad 2.
2. No sitúe el producto encima de superficies, vehículos, estantes o mesas, que por sus características de peso o de estabilidad no sean aptos para él. Siga siempre las instrucciones de instalación del fabricante cuando instale y asegure el producto en objetos o estructuras (p. ej. paredes y estantes). Si se realiza la instalación de modo distinto al indicado en la documentación del producto, se pueden causar lesiones o, en determinadas circunstancias, incluso la muerte.
3. No ponga el producto sobre aparatos que generen calor (p. ej. radiadores o calefactores). La temperatura ambiente no debe superar la temperatura máxima especificada en la documentación del producto o en la hoja de datos. En caso de sobrecalentamiento del producto, pueden producirse choques eléctricos, incendios y/o lesiones graves con posible consecuencia de muerte.

Seguridad eléctrica

Si no se siguen (o se siguen de modo insuficiente) las indicaciones del fabricante en cuanto a seguridad eléctrica, pueden producirse choques eléctricos, incendios y/o lesiones graves con posible consecuencia de muerte.

1. Antes de la puesta en marcha del producto se deberá comprobar siempre que la tensión preseleccionada en el producto coincida con la de la red de alimentación eléctrica. Si es necesario modificar el ajuste de tensión, también se deberán cambiar en caso dado los fusibles correspondientes del producto.
2. Los productos de la clase de protección I con alimentación móvil y enchufe individual solamente podrán enchufarse a tomas de corriente con contacto de seguridad y con conductor de protección conectado.
3. Queda prohibida la interrupción intencionada del conductor de protección, tanto en la toma de corriente como en el mismo producto. La interrupción puede tener como consecuencia el riesgo de que el producto sea fuente de choques eléctricos. Si se utilizan cables alargadores o regletas de enchufe, deberá garantizarse la realización de un examen regular de los mismos en cuanto a su estado técnico de seguridad.
4. Si el producto no está equipado con un interruptor para desconectarlo de la red, o bien si el interruptor existente no resulta apropiado para la desconexión de la red, el enchufe del cable de conexión se deberá considerar como un dispositivo de desconexión. El dispositivo de desconexión se debe poder alcanzar fácilmente y debe estar siempre bien accesible. Si, p. ej., el enchufe de conexión a la red es el dispositivo de desconexión, la longitud del cable de conexión no debe superar 3 m). Los interruptores selectores o electrónicos no son aptos para el corte de la red eléctrica. Si se integran productos sin interruptor en bastidores o instalaciones, se deberá colocar el interruptor en el nivel de la instalación.
5. No utilice nunca el producto si está dañado el cable de conexión a red. Compruebe regularmente el correcto estado de los cables de conexión a red. Asegúrese, mediante las medidas de protección y de instalación adecuadas, de que el cable de conexión a red no pueda ser dañado o de que nadie pueda ser dañado por él, p. ej. al tropezar o por un choque eléctrico.

Instrucciones de seguridad elementales

6. Solamente está permitido el funcionamiento en redes de alimentación TN/TT aseguradas con fusibles de 16 A como máximo (utilización de fusibles de mayor amperaje solo previa consulta con el grupo de empresas Rohde & Schwarz).
7. Nunca conecte el enchufe en tomas de corriente sucias o llenas de polvo. Introduzca el enchufe por completo y fuertemente en la toma de corriente. La no observación de estas medidas puede provocar chispas, fuego y/o lesiones.
8. No sobrecargue las tomas de corriente, los cables alargadores o las regletas de enchufe ya que esto podría causar fuego o choques eléctricos.
9. En las mediciones en circuitos de corriente con una tensión $U_{\text{eff}} > 30 \text{ V}$ se deberán tomar las medidas apropiadas para impedir cualquier peligro (p. ej. medios de medición adecuados, seguros, limitación de tensión, corte protector, aislamiento etc.).
10. Para la conexión con dispositivos informáticos como un PC o un ordenador industrial, debe comprobarse que éstos cumplan los estándares IEC60950-1/EN60950-1 o IEC61010-1/EN 61010-1 válidos en cada caso.
11. A menos que esté permitido expresamente, no retire nunca la tapa ni componentes de la carcasa mientras el producto esté en servicio. Esto pone a descubierto los cables y componentes eléctricos y puede causar lesiones, fuego o daños en el producto.
12. Si un producto se instala en un lugar fijo, se deberá primero conectar el conductor de protección fijo con el conductor de protección del producto antes de hacer cualquier otra conexión. La instalación y la conexión deberán ser efectuadas por un electricista especializado.
13. En el caso de dispositivos fijos que no estén provistos de fusibles, interruptor automático ni otros mecanismos de seguridad similares, el circuito de alimentación debe estar protegido de modo que todas las personas que puedan acceder al producto, así como el producto mismo, estén a salvo de posibles daños.
14. Todo producto debe estar protegido contra sobretensión (debida p. ej. a una caída del rayo) mediante los correspondientes sistemas de protección. Si no, el personal que lo utilice quedará expuesto al peligro de choque eléctrico.
15. No debe introducirse en los orificios de la caja del aparato ningún objeto que no esté destinado a ello. Esto puede producir cortocircuitos en el producto y/o puede causar choques eléctricos, fuego o lesiones.
16. Salvo indicación contraria, los productos no están impermeabilizados (ver también el capítulo "Estados operativos y posiciones de funcionamiento", punto 1). Por eso es necesario tomar las medidas necesarias para evitar la entrada de líquidos. En caso contrario, existe peligro de choque eléctrico para el usuario o de daños en el producto, que también pueden redundar en peligro para las personas.
17. No utilice el producto en condiciones en las que pueda producirse o ya se hayan producido condensaciones sobre el producto o en el interior de éste, como p. ej. al desplazarlo de un lugar frío a otro caliente. La entrada de agua aumenta el riesgo de choque eléctrico.
18. Antes de la limpieza, desconecte por completo el producto de la alimentación de tensión (p. ej. red de alimentación o batería). Realice la limpieza de los aparatos con un paño suave, que no se deshilache. No utilice bajo ningún concepto productos de limpieza químicos como alcohol, acetona o diluyentes para lacas nitrocelulósicas.

Instrucciones de seguridad elementales

Funcionamiento

1. El uso del producto requiere instrucciones especiales y una alta concentración durante el manejo. Debe asegurarse que las personas que manejen el producto estén a la altura de los requerimientos necesarios en cuanto a aptitudes físicas, psíquicas y emocionales, ya que de otra manera no se pueden excluir lesiones o daños de objetos. El empresario u operador es responsable de seleccionar el personal usuario apto para el manejo del producto.
2. Antes de desplazar o transportar el producto, lea y tenga en cuenta el capítulo "Transporte".
3. Como con todo producto de fabricación industrial no puede quedar excluida en general la posibilidad de que se produzcan alergias provocadas por algunos materiales empleados —los llamados alérgenos (p. ej. el níquel)—. Si durante el manejo de productos Rohde & Schwarz se producen reacciones alérgicas, como p. ej. irritaciones cutáneas, estornudos continuos, enrojecimiento de la conjuntiva o dificultades respiratorias, debe avisarse inmediatamente a un médico para investigar las causas y evitar cualquier molestia o daño a la salud.
4. Antes de la manipulación mecánica y/o térmica o el desmontaje del producto, debe tenerse en cuenta imprescindiblemente el capítulo "Eliminación/protección del medio ambiente", punto 1.
5. Ciertos productos, como p. ej. las instalaciones de radiocomunicación RF, pueden a causa de su función natural, emitir una radiación electromagnética aumentada. Deben tomarse todas las medidas necesarias para la protección de las mujeres embarazadas. También las personas con marcapasos pueden correr peligro a causa de la radiación electromagnética. El empresario/operador tiene la obligación de evaluar y señalar las áreas de trabajo en las que exista un riesgo elevado de exposición a radiaciones.
6. Tenga en cuenta que en caso de incendio pueden desprenderse del producto sustancias tóxicas (gases, líquidos etc.) que pueden generar daños a la salud. Por eso, en caso de incendio deben usarse medidas adecuadas, como p. ej. máscaras antigás e indumentaria de protección.
7. Los productos con láser están provistos de indicaciones de advertencia normalizadas en función de la clase de láser del que se trate. Los rayos láser pueden provocar daños de tipo biológico a causa de las propiedades de su radiación y debido a su concentración extrema de potencia electromagnética. En caso de que un producto Rohde & Schwarz contenga un producto láser (p. ej. un lector de CD/DVD), no debe usarse ninguna otra configuración o función aparte de las descritas en la documentación del producto, a fin de evitar lesiones (p. ej. debidas a irradiación láser).
8. Clases de compatibilidad electromagnética (conforme a EN 55011 / CISPR 11; y en analogía con EN 55022 / CISPR 22, EN 55032 / CISPR 32)
 - Aparato de clase A:
Aparato adecuado para su uso en todos los entornos excepto en los residenciales y en aquellos conectados directamente a una red de distribución de baja tensión que suministra corriente a edificios residenciales.
Nota: Los aparatos de clase A están destinados al uso en entornos industriales. Estos aparatos pueden causar perturbaciones radioeléctricas en entornos residenciales debido a posibles perturbaciones guiadas o radiadas. En este caso, se le podrá solicitar al operador que tome las medidas adecuadas para eliminar estas perturbaciones.
 - Aparato de clase B:
Aparato adecuado para su uso en entornos residenciales, así como en aquellos conectados directamente a una red de distribución de baja tensión que suministra corriente a edificios residenciales.

Instrucciones de seguridad elementales

Reparación y mantenimiento

1. El producto solamente debe ser abierto por personal especializado con autorización para ello. Antes de manipular el producto o abrirlo, es obligatorio desconectarlo de la tensión de alimentación, para evitar toda posibilidad de choque eléctrico.
2. El ajuste, el cambio de partes, el mantenimiento y la reparación deberán ser efectuadas solamente por electricistas autorizados por Rohde & Schwarz. Si se reponen partes con importancia para los aspectos de seguridad (p. ej. el enchufe, los transformadores o los fusibles), solamente podrán ser sustituidos por partes originales. Después de cada cambio de partes relevantes para la seguridad deberá realizarse un control de seguridad (control a primera vista, control del conductor de protección, medición de resistencia de aislamiento, medición de la corriente de fuga, control de funcionamiento). Con esto queda garantizada la seguridad del producto.

Baterías y acumuladores o celdas

Si no se siguen (o se siguen de modo insuficiente) las indicaciones en cuanto a las baterías y acumuladores o celdas, pueden producirse explosiones, incendios y/o lesiones graves con posible consecuencia de muerte. El manejo de baterías y acumuladores con electrolitos alcalinos (p. ej. celdas de litio) debe seguir el estándar EN 62133.

1. No deben desmontarse, abrirse ni triturarse las celdas.
2. Las celdas o baterías no deben someterse a calor ni fuego. Debe evitarse el almacenamiento a la luz directa del sol. Las celdas y baterías deben mantenerse limpias y secas. Limpiar las conexiones sucias con un paño seco y limpio.
3. Las celdas o baterías no deben cortocircuitarse. Es peligroso almacenar las celdas o baterías en estuches o cajones en cuyo interior puedan cortocircuitarse por contacto recíproco o por contacto con otros materiales conductores. No deben extraerse las celdas o baterías de sus embalajes originales hasta el momento en que vayan a utilizarse.
4. Las celdas o baterías no deben someterse a impactos mecánicos fuertes indebidos.
5. En caso de falta de estanqueidad de una celda, el líquido vertido no debe entrar en contacto con la piel ni los ojos. Si se produce contacto, lavar con agua abundante la zona afectada y avisar a un médico.
6. En caso de cambio o recarga inadecuados, las celdas o baterías que contienen electrolitos alcalinos (p. ej. las celdas de litio) pueden explotar. Para garantizar la seguridad del producto, las celdas o baterías solo deben ser sustituidas por el tipo Rohde & Schwarz correspondiente (ver lista de recambios).
7. Las baterías y celdas deben reciclarse y no deben tirarse a la basura doméstica. Las baterías o acumuladores que contienen plomo, mercurio o cadmio deben tratarse como residuos especiales. Respete en esta relación las normas nacionales de eliminación y reciclaje.

Transporte

1. El producto puede tener un peso elevado. Por eso es necesario desplazarlo o transportarlo con precaución y, si es necesario, usando un sistema de elevación adecuado (p. ej. una carretilla elevadora), a fin de evitar lesiones en la espalda u otros daños personales.

Instrucciones de seguridad elementales

2. Las asas instaladas en los productos sirven solamente de ayuda para el transporte del producto por personas. Por eso no está permitido utilizar las asas para la sujeción en o sobre medios de transporte como p. ej. grúas, carretillas elevadoras de horquilla, carros etc. Es responsabilidad suya fijar los productos de manera segura a los medios de transporte o elevación. Para evitar daños personales o daños en el producto, siga las instrucciones de seguridad del fabricante del medio de transporte o elevación utilizado.
3. Si se utiliza el producto dentro de un vehículo, recae de manera exclusiva en el conductor la responsabilidad de conducir el vehículo de manera segura y adecuada. El fabricante no asumirá ninguna responsabilidad por accidentes o colisiones. No utilice nunca el producto dentro de un vehículo en movimiento si esto pudiera distraer al conductor. Asegure el producto dentro del vehículo debidamente para evitar, en caso de un accidente, lesiones u otra clase de daños.

Eliminación/protección del medio ambiente

1. Los dispositivos marcados contienen una batería o un acumulador que no se debe desechar con los residuos domésticos sin clasificar, sino que debe ser recogido por separado. La eliminación se debe efectuar exclusivamente a través de un punto de recogida apropiado o del servicio de atención al cliente de Rohde & Schwarz.
2. Los dispositivos eléctricos usados no se deben desechar con los residuos domésticos sin clasificar, sino que deben ser recogidos por separado.
Rohde & Schwarz GmbH & Co.KG ha elaborado un concepto de eliminación de residuos y asume plenamente los deberes de recogida y eliminación para los fabricantes dentro de la UE. Para desechar el producto de manera respetuosa con el medio ambiente, dirijase a su servicio de atención al cliente de Rohde & Schwarz.
3. Si se trabaja de manera mecánica y/o térmica cualquier producto o componente más allá del funcionamiento previsto, pueden liberarse sustancias peligrosas (polvos con contenido de metales pesados como p. ej. plomo, berilio o níquel). Por eso el producto solo debe ser desmontado por personal especializado con formación adecuada. Un desmontaje inadecuado puede ocasionar daños para la salud. Se deben tener en cuenta las directivas nacionales referentes a la eliminación de residuos.
4. En caso de que durante el trato del producto se formen sustancias peligrosas o combustibles que deban tratarse como residuos especiales (p. ej. refrigerantes o aceites de motor con intervalos de cambio definidos), deben tenerse en cuenta las indicaciones de seguridad del fabricante de dichas sustancias y las normas regionales de eliminación de residuos. Tenga en cuenta también en caso necesario las indicaciones de seguridad especiales contenidas en la documentación del producto. La eliminación incorrecta de sustancias peligrosas o combustibles puede causar daños a la salud o daños al medio ambiente.

Se puede encontrar más información sobre la protección del medio ambiente en la página web de Rohde & Schwarz.

Customer Support

Technical support – where and when you need it

For quick, expert help with any Rohde & Schwarz equipment, contact one of our Customer Support Centers. A team of highly qualified engineers provides telephone support and will work with you to find a solution to your query on any aspect of the operation, programming or applications of Rohde & Schwarz equipment.

Up-to-date information and upgrades

To keep your instrument up-to-date and to be informed about new application notes related to your instrument, please send an e-mail to the Customer Support Center stating your instrument and your wish. We will take care that you will get the right information.

Europe, Africa, Middle East

Phone +49 89 4129 12345
customersupport@rohde-schwarz.com

North America

Phone 1-888-TEST-RSA (1-888-837-8772)
customer.support@rsa.rohde-schwarz.com

Latin America

Phone +1-410-910-7988
customersupport.la@rohde-schwarz.com

Asia/Pacific

Phone +65 65 13 04 88
customersupport.asia@rohde-schwarz.com

China

Phone +86-800-810-8228 /
+86-400-650-5896
customersupport.china@rohde-schwarz.com



Contents

1	Preface	13
1.1	Documentation Overview.....	13
1.2	Typographical Conventions.....	14
1.3	Notes on Screenshots.....	14
2	Preparing for Use	15
2.1	Front Panel Tour.....	15
2.1.1	Utility Keys.....	15
2.1.2	Standby LEDs and Standby Key.....	16
2.1.3	Display.....	17
2.1.4	Setup Keys.....	17
2.1.4.1	Keys for Setting Parameters.....	17
2.1.4.2	Display Keys.....	18
2.1.5	Keypad for data entry.....	18
2.1.6	Rotary Knob and Navigation Keys.....	19
2.1.7	Front Panel Connectors.....	20
2.2	Rear Panel Tour.....	21
2.2.1	Description of the Connectors.....	22
2.3	Putting into Operation.....	24
2.3.1	EMI Suppression.....	25
2.3.2	Unpacking and Checking the Instrument.....	26
2.3.3	Placing or Mounting the Instrument.....	26
2.3.4	Connecting the Instrument to the AC Supply.....	28
2.3.5	Starting the Instrument.....	28
2.3.5.1	Standby and Ready state.....	29
2.3.5.2	Start Display and Booting.....	29
2.3.5.3	Function Check.....	29
2.3.5.4	Default Settings.....	30
2.3.6	Shutting Down the Instrument.....	31
2.3.7	Power Fuses.....	31
2.4	Connecting External Accessories.....	32
2.4.1	Connecting USB Devices.....	32

2.5 Linux Operating System.....	33
2.6 Setting Up a Network (LAN) Connection.....	34
2.6.1 Connecting the Instrument to the Network.....	35
2.6.2 Assigning the IP Address.....	36
2.6.3 Using Computer Names.....	37
2.7 Remote Access via an External Controller.....	37
2.7.1 Using a Web Browser for Remote Access.....	39
2.7.2 Remote Access via a VNC Client Software.....	40
2.8 LXI Configuration.....	45
2.8.1 LXI Browser Settings.....	46
2.8.2 LAN Configuration.....	47
2.8.2.1 IP Configuration.....	48
2.8.2.2 Advanced LAN Configuration.....	48
2.8.2.3 Ping Client.....	49
2.8.2.4 Web Control.....	50
2.8.2.5 SCPI Remote Trace.....	51
3 Getting Started.....	54
3.1 Brief Introduction to the Instrument's Concept.....	54
3.2 Application Field of the Instrument.....	56
3.3 Description of Individual Diagram Blocks.....	56
3.4 Example of Setup.....	59
4 Manual Operation.....	64
4.1 Key Features.....	64
4.2 Display.....	67
4.2.1 Settings Displayed in the Header Section.....	67
4.2.2 Status Information and Messages.....	68
4.2.2.1 Status Information.....	68
4.2.2.2 Messages.....	68
4.2.2.3 Volatile messages.....	68
4.2.2.4 Permanent Messages.....	69
4.2.3 Info Window.....	69
4.2.4 Block Diagram	70
4.2.4.1 Function Blocks in the Block Diagram.....	70

4.2.4.2	Signal Flow and Input/Output Symbols in the Block Diagram.....	71
4.2.5	Structure of the Dialogs.....	71
4.3	Accessing Dialogs.....	72
4.4	Setting Parameters.....	73
4.4.1	Working with the Cursor.....	74
4.4.2	Selecting a Control Element.....	74
4.4.3	Switching Parameters On/Off.....	75
4.4.4	Entering a Value.....	75
4.4.5	Working with Units	77
4.4.6	Selecting a Value from a List.....	77
4.4.7	Terminating Entries with Confirmation.....	78
4.4.8	Restoring the Previous Value.....	78
4.5	Editors.....	79
4.5.1	Working with List Editor.....	80
4.6	How to Use the Help System.....	81
4.7	File Management.....	82
4.7.1	File Select Dialog.....	84
4.7.2	File Manager.....	85
4.7.2.1	Extensions for User Files.....	85
4.8	Legend of Front-Panel Controls.....	86
4.8.1	Front Panel Key Emulation.....	87
5	Instrument Function.....	89
5.1	Overview of Instrument Functions.....	89
5.2	General Instrument Settings.....	90
5.2.1	Overview of General Instrument Settings.....	90
5.2.2	Default Instrument Settings - Preset Key.....	91
5.2.3	General Configuration of Instrument - Setup Key.....	91
5.2.3.1	Internal Adjustments.....	92
5.2.3.2	Hardware Config.....	94
5.2.3.3	Software / Options.....	95
5.2.3.4	Manage License Keys.....	96
5.2.3.5	NRP-Z Info/Update.....	97
5.2.3.6	SMZ Info Update.....	99

5.2.3.7	Display Update.....	100
5.2.3.8	Selftest.....	100
5.2.3.9	Check Front Panel.....	101
5.2.3.10	Shutting Down and Rebooting the Instrument.....	102
5.2.3.11	Date and Time	103
5.2.3.12	Network Settings	104
5.2.3.13	Display/Keyboard Settings.....	107
5.2.3.14	Remote Channel Settings.....	108
5.2.3.15	Instrument Emulations.....	110
5.2.3.16	LXI Status.....	112
5.2.3.17	Protection.....	113
5.2.3.18	Security.....	114
5.2.3.19	Save/Recall.....	120
5.2.3.20	Factory Preset.....	120
5.2.3.21	Help.....	121
5.2.4	Switching to Manual Control - Local Key.....	121
5.2.5	Generating a Hard Copy of the Display.....	122
5.2.5.1	Hard Copy Settings.....	122
5.2.5.2	Hardcopy Options.....	123
5.2.6	Messages - Info Key.....	125
5.2.7	Help System - Help Key.....	125
5.2.8	Storing and Loading Instrument Data - File Key.....	126
5.2.8.1	Save/Recall Menu.....	127
5.2.8.2	Storing Instrument Settings.....	127
5.2.8.3	Loading Instrument Settings.....	128
5.2.8.4	File Manager.....	130
5.2.8.5	Accessing the File System of the Instrument and Transferring Files from and to the Instrument.....	132
5.3	RF Block.....	135
5.3.1	Overview of RF Signal.....	135
5.3.1.1	RF Output.....	135
5.3.1.2	RF Signal Modes and Characteristics.....	136
5.3.2	RF Frequency.....	137
5.3.2.1	RF Frequency vs. RF Output Frequency.....	137

5.3.2.2	Setting the RF Frequency.....	138
5.3.2.3	RF Frequency Dialog.....	138
5.3.2.4	Frequency Settings.....	138
5.3.2.5	User Variation Settings.....	140
5.3.3	Phase.....	140
5.3.3.1	Phase Settings.....	140
5.3.4	Reference Oscillator.....	141
5.3.4.1	Reference Oscillator Settings.....	143
5.3.5	RF Level.....	145
5.3.5.1	Overview of RF Level.....	145
5.3.5.2	RF Level Dialog.....	146
5.3.5.3	Power-On/EMF Settings.....	151
5.3.5.4	Automatic Level Control - ALC.....	151
5.3.5.5	NRP-Z Level Control.....	154
5.3.5.6	User Correction.....	158
5.3.5.7	Reverse Power Protection.....	165
5.3.6	RF Measurement.....	166
5.3.6.1	NRP-Z Power Viewer.....	166
5.3.7	RF Sweep and List Mode.....	174
5.3.7.1	Overview.....	174
5.3.7.2	RF Frequency Sweep.....	175
5.3.7.3	RF Level Sweep.....	182
5.3.7.4	List Mode.....	187
5.4	Modulation.....	196
5.4.1	Overview of Modulation.....	196
5.4.1.1	Enabling/Disabling Analog Modulations using the MOD On/Off Key.....	197
5.4.1.2	Modulation Sources.....	197
5.4.2	Amplitude Modulation (AM).....	198
5.4.2.1	Amplitude Modulation Settings.....	199
5.4.3	Frequency Modulation (FM).....	202
5.4.3.1	Frequency Modulation Settings.....	202
5.4.4	Phase Modulation (PhiM).....	206
5.4.4.1	Phase Modulation Dialog.....	206

5.4.5	Pulse Modulation (PM).....	209
5.4.5.1	Pulse Modulation Settings.....	210
5.4.6	Stereo Modulation.....	211
5.4.6.1	Stereo Modulation Dialog.....	212
5.5	Modulation Generator and LF Output.....	218
5.5.1	Overview of LF Generator.....	218
5.5.2	LF Output.....	218
5.5.2.1	LF Output Dialog.....	219
5.5.3	LF Frequency Sweep.....	220
5.5.4	Pulse Generator.....	226
5.5.4.1	Pulse Generator Settings.....	226
5.5.4.2	Pulse Train Generation.....	230
6	Remote Control Basics.....	235
6.1	Remote Control Interfaces and Protocols.....	235
6.1.1	VISA Libraries.....	236
6.1.2	Messages.....	236
6.1.3	LAN Interface.....	237
6.1.3.1	HiSLIP Protocol.....	239
6.1.3.2	VXI-11 Protocol.....	239
6.1.3.3	Socket Communication.....	239
6.1.3.4	LAN Interface Messages.....	240
6.1.4	USB Interface.....	240
6.1.5	Serial Interface.....	241
6.1.6	GPIB Interface (IEC/IEEE Bus Interface).....	241
6.1.6.1	GPIB Interface Messages.....	242
6.1.6.2	GPIB Instrument Address.....	243
6.1.7	LXI Browser Interface.....	243
6.2	Starting a Remote Control Session.....	244
6.2.1	Switching to Remote Control.....	244
6.2.2	Returning to Manual Operation.....	245
6.2.3	Examples.....	245
6.2.3.1	Remote Control over GPIB.....	246
6.2.3.2	Remote Control over LAN using VXI-11 Protocol.....	246

6.2.3.3	Remote Control over LAN using Socket Communication.....	251
6.3	SCPI Command Structure.....	258
6.3.1	Syntax for Common Commands.....	258
6.3.2	Syntax for Device-Specific Commands.....	259
6.3.3	SCPI Parameters.....	261
6.3.4	Overview of Syntax Elements.....	264
6.3.5	Structure of a command line.....	264
6.3.6	Responses to Queries.....	265
6.4	Command Sequence and Synchronization.....	266
6.4.1	Preventing Overlapping Execution.....	267
6.5	Status Reporting System.....	269
6.5.1	Hierarchy of the Status Registers.....	269
6.5.2	Structure of a SCPI Status Register.....	271
6.5.3	Status Byte (STB) and Service Request Enable Register (SRE).....	273
6.5.4	Event Status Register (ESR) and Event Status Enable Register (ESE).....	274
6.5.5	Questionable Status Register (STATus:QUESTionable).....	274
6.5.6	Operation Status Register (STATus:OPERation).....	275
6.5.7	Application of the Status Reporting System.....	275
6.5.7.1	Service Request.....	275
6.5.7.2	Serial Poll.....	276
6.5.7.3	Query of an instrument status.....	276
6.5.7.4	Error Queue.....	276
6.5.8	Reset Values of the Status Reporting System.....	277
6.6	General Programming Recommendations.....	277
7	Remote Control Commands.....	279
7.1	Conventions used in SCPI Command Descriptions.....	279
7.2	Common Commands.....	279
7.3	Preset Commands.....	284
7.4	CALibration Subsystem.....	286
7.5	DIAGnostic Subsystem.....	288
7.6	DISPlay Subsystem.....	290
7.7	FORMat Subsystem.....	293
7.8	HCOPy Subsystem.....	294

7.9	KBOard Subsystem	301
7.10	MMEMory Subsystem	302
7.10.1	File Naming Conventions.....	303
7.10.2	Extensions for User Files.....	303
7.10.3	Examples.....	304
7.10.4	Remote Control Commands.....	305
7.11	OUTPut Subsystem	311
7.12	SENSe, READ and INITiate Subsystems	315
7.13	SOURce Subsystem	325
7.13.1	SOURce:AM Subsystem.....	325
7.13.2	SOURce:CORRection Subsystem.....	328
7.13.3	SOURce:FM Subsystem.....	337
7.13.4	SOURce:FREQuency Subsystem.....	340
7.13.5	SOURce:INPut Subsystem.....	347
7.13.6	SOURce:LFOutput Subsystem.....	348
7.13.7	SOURce:LIST Subsystem.....	358
7.13.8	SOURce:MODulation Subsystem.....	371
7.13.9	SOURce:PGEN Subsystem.....	371
7.13.10	SOURce:PHASe Subsystem.....	372
7.13.11	SOURce:PM Subsystem.....	373
7.13.12	SOURce:POWer Subsystem.....	376
7.13.13	SOURce:PULM Subsystem.....	387
7.13.14	SOURce:ROSCillator Subsystem.....	405
7.13.15	SOURce:STEReo Subsystem.....	408
7.13.16	SOURce:SWEep Subsystem.....	417
7.14	STATus Subsystem	429
7.15	SYSTem Subsystem	433
7.16	TEST Subsystem	448
7.17	TRIGger Subsystem	449
7.18	UNIT Subsystem	455
7.19	Direct Commands for the Stereo/RDS Coder Option R&S SMB-B5	456
7.19.1	Remote-Control Commands.....	456
7.19.2	Examples.....	477

7.19.2.1	Alternative Frequency Lists.....	477
7.19.2.2	Enhanced Other Networks.....	478
7.19.2.3	Free Format Groups (FFGs).....	479
7.19.2.4	Transparent-Mode.....	479
8	Maintenance.....	480
8.1	Storing and Packing.....	480
9	Status Information, Error Messages and Troubleshooting.....	481
9.1	Status Information.....	481
9.1.1	Status information displayed between the frequency and level fields.....	481
9.1.2	Status information displayed to the left of the Info line.....	483
9.1.3	Status information displayed in the Info line.....	483
9.2	Error Messages.....	484
9.2.1	Volatile messages.....	484
9.2.2	Permanent messages.....	485
9.3	SCPI-Error Messages.....	485
9.4	Device-Specific Error Messages.....	485
9.5	Resolving Network Connection Failures.....	487
9.6	Obtaining Technical Support.....	488
	Annex.....	490
A	Hardware Interfaces.....	490
A.1	GPIB Bus Interface.....	490
	List of Commands.....	492
	Index.....	502

1 Preface

1.1 Documentation Overview

This section provides an overview of the R&S SMB user documentation. You find it on the product page at:

<http://www.rohde-schwarz.com/product/SMB100A.html> > "Downloads"

Quick start guide

Introduces the R&S SMB and describes how to set up and start working with the product. Includes basic operations, typical measurement examples, and general information, e.g. safety instructions, etc. A printed version is delivered with the instrument.

Online help

Offers quick, context-sensitive access to the complete information directly on the instrument.

Operating manual

Contains the description of all instrument modes and functions. It also provides an introduction to remote control, a complete description of the remote control commands with programming examples, and information on maintenance, instrument interfaces and error messages. Includes the contents of the quick start guide manual.

The **online version** of the operating manual provides the complete contents for immediate display on the Internet.

Service manual

Describes the performance test for checking the rated specifications, module replacement and repair, firmware update, troubleshooting and fault elimination, and contains mechanical drawings and spare part lists.

Instrument security procedures manual

Deals with security issues when working with the R&S SMB in secure areas.

Basic safety instructions

Contains safety instructions, operating conditions and further important information. The printed document is delivered with the instrument.

Data sheet and brochure

The data sheet contains the technical specifications of the R&S SMB. It also lists the options and their order numbers as well as optional accessories.

The brochure provides an overview of the instrument and deals with the specific characteristics.

Release notes and open source acknowledgment (OSA)

The release notes list new features, improvements and known issues of the current firmware version, and describe the firmware installation.

The open source acknowledgment document provides verbatim license texts of the used open source software.

See <http://www.rohde-schwarz.com/product/SMB100A.html> > "Downloads" > "Firmware"

Application notes, application cards, white papers, etc.

These documents deal with special applications or background information on particular topics, see <http://www.rohde-schwarz.com/appnotes>.

1.2 Typographical Conventions

The following text markers are used throughout this documentation:

Convention	Description
"Graphical user interface elements"	All names of graphical user interface elements on the screen, such as dialog boxes, menus, options, buttons, and softkeys are enclosed by quotation marks.
KEYS	Key names are written in capital letters.
File names, commands, program code	File names, commands, coding samples and screen output are distinguished by their font.
<i>Input</i>	Input to be entered by the user is displayed in italics.
Links	Links that you can click are displayed in blue font.
"References"	References to other parts of the documentation are enclosed by quotation marks.

1.3 Notes on Screenshots

When describing the functions of the product, we use sample screenshots. These screenshots are meant to illustrate as much as possible of the provided functions and possible interdependencies between parameters. The shown values may not represent realistic test situations.

The screenshots usually show a fully equipped product, that is: with all options installed. Thus, some functions shown in the screenshots may not be available in your particular product configuration.

2 Preparing for Use

The following topics help you to get familiar with the instrument and perform the first steps:

- [Front Panel Tour](#)
- [Rear Panel Tour](#)
- [Putting into Operation](#)

This section explains the control elements and connectors of the Signal Generator R&S SMB with the aid of the front and rear views and describes how to put the instrument into operation. It also describes the connection of peripherals such as printer, keyboard or mouse. Specifications of interfaces can be found in the data sheet.

The [Chapter 3, "Getting Started"](#), on page 54 of this manual provides an overview of the generator functions and introduces the operating concept. Detailed operating instructions and an overview of menus follow in [Chapter 4, "Manual Operation"](#), on page 64.

For all reference information concerning manual and remote control of the instrument, refer to the online help system or its printed/printable version. A more detailed description of the hardware connectors and interfaces is also part of the help system.

2.1 Front Panel Tour

The front panel of the R&S SMB consists of the VGA display, some utility keys (left side) and the hardkey area with connectors and control interfaces (right side). The subsequent sections provide brief explanations on the controls and connectors, the hardkey area and the front panel.

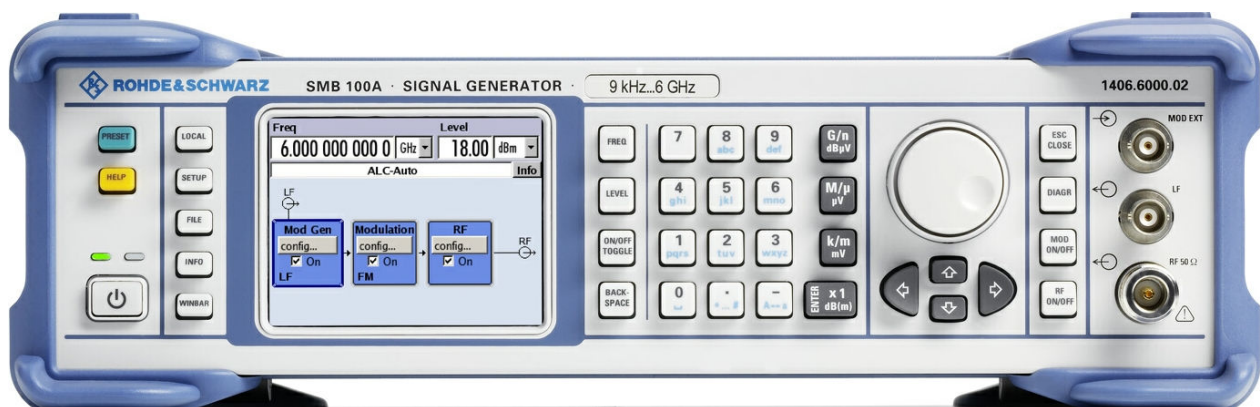

Figure 2-1: Front panel view

2.1.1 Utility Keys



The keys to the left of the display cause the R&S SMB to return to a definite instrument state and provide information on the instrument and assistance.

For more information refer to chapter "Instrument Settings".

PRESET

Sets the instrument to a defined state (see [Chapter 2.3.5.4, "Default Settings"](#), on page 30).

LOCAL

Switches from remote control to local (manual) control.

SETUP

Opens the "Setup" dialog for configuring presettings.

For more information, see [Chapter 5.2.3, "General Configuration of Instrument - Setup Key"](#), on page 91.

FILE

Activates the menu for storing or loading files (see [Chapter 4.7, "File Management"](#), on page 82).

INFO

Displays status messages, error messages and warnings.

WINBAR

Toggles between the diagram and active menus.

HELP

Displays context-sensitive help text.

2.1.2 Standby LEDs and Standby Key

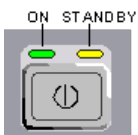

The standby LEDs and the ON/STANDBY key are located in the bottom left corner of the front panel.

The ON/STANDBY key toggles the instrument between standby and ready state (indicated by the standby LEDs).

The standby LEDs indicate the instrument states as follow:

- the green LED (left) is on when the instrument is ready for operation,
- the yellow LED (right) is on in the standby mode.

See also [Chapter 2.3.5.1, "Standby and Ready state"](#), on page 29.

2.1.3 Display

The display clearly shows all main settings and signal generator states.

The display is divided into the following sections:

- Frequency and level display with info line
 - Frequency and level settings containing offset.
 - Status messages
 - Brief error messages.
To access an window with detailed information for a message, use the INFO key.
- Block diagram
The block diagram shows the current configuration and the signal flow in the generator with the aid of function blocks containing an on/off switch. Selecting a function block opens a list of associated setting menus. Active menus, info windows and graphs are displayed on top of the block diagram. The block diagram can be displayed in the foreground anytime with the **DIAGRAM** key.

For detailed information, see [Chapter 4.2, "Display"](#), on page 67.

2.1.4 Setup Keys

The keys to the right of the display set parameters, select views and control the windows.

2.1.4.1 Keys for Setting Parameters



These keys provide direct access to the settings in the header of the instrument for fast setting the RF signal.

For more information refer to chapter "Instrument Functions".

FREQ

Activates frequency entry.

LEVEL

Activates level entry.

ON/OFF TOGGLE

- Switches highlighted elements or a function block on and off.
- Switches between two or more settings, e.g. items of selection lists. At the end of a list, the cursor is set on the first entry again.

BACKSPACE

Deletes the character to the left of the cursor.

2.1.4.2 Display Keys

The keys assigned right to rotary knob arrange different windows on the display, and turn the RF signal and the modulation on and off.

DIAGRAM

Brings the block diagram to the foreground. Active menus are minimized.

ESC

The function of this key depends on the current cursor position.

- Calls the next higher selection level.
- Closes the open window without accepting new entries; the old value or parameter is retained.
- In dialog boxes that contain a "Cancel" button it activates that button.
- Closes all kinds of dialog boxes, if the edit mode is not active.
- Quits the edit mode, if the edit mode is active.
- Switches between different entry fields of a menu.
- Shifts the entry cursor from the header display to the previously active menu, or to the previously highlighted block in the block diagram if no menu is active.

MOD ON/OFF

Switches the modulations on and off.

"MOD OFF" is displayed in the info line of the header next to the "Level" field.

RF ON/OFF

Switches the RF signal on and off.

"RF OFF" is displayed in the header next to the "Frequency" field.

2.1.5 Keypad for data entry

The keys in the data entry keypad are used to enter alphanumeric data and units.

Data entry keys are only enabled while the cursor is placed on a data input field in a dialog. Their function depends on the data type of the input field.



Keys	Description
0...9/abc	Enters the corresponding numbers (in numeric input fields) or characters (character input fields).
.	Inserts a decimal point (numeric input fields) or dot (character input fields) at the cursor position. Multiple decimal points are not allowed.
Unit keys	Selects a unit and thus determine the absolute value, or changes the unit, i.e. trigger a recalculation without changing the absolute value. The function depends on the time at which the UNIT key is used during parameter entry (see Chapter 4.4.5, "Working with Units" , on page 77). For unit-free values, the X1 key is equivalent to ENTER. It confirms the previous entry and deactivates the input field.
_	Adds a blank in a character input field.
*... #	Enters special characters. Toggles through the available characters if the key is pressed several times in a row.
A <-> a	Toggles between uppercase and lowercase characters.
A, B, C, D, E, F	Enters hexadecimal values. The letters assigned to the keys are automatically active when an entry field with a hexadecimal value is active.

ENTER

Pressing the rotary knob has the same effect.

- Concludes the entry of dimensionless entries. For other entries, this key can be used instead of the default unit key. The new value is accepted.
- Confirms ("OK") and closes open input windows.
- In a dialog box, selects the default or focused button.
- In a dialog box, activates the edit mode for the focused area, if available.
- In a dialog box, activates or deactivates the selected option of the focused area, if the edit mode is active.
- Calls the next menu level.

2.1.6 Rotary Knob and Navigation Keys

The rotary knob and the arrow keys are alternative control elements for data variation and navigation in the graphical user interface.



ROTARY KNOB

The rotary knob has several functions:

- Increases (clockwise direction) or decreases (counter-clockwise direction) numeric values at a defined step width in editing mode
- Moves the cursor, e.g. to a function block in the block diagram
- Scrolls within lists, tables or tree views
- Acts like the ENTER key, when it is pressed.
- Shifts the selection bar within focused areas (e.g. lists), if the edit mode is activated.

Note: Turning or pressing the rotary knob is equivalent to pressing the UP and DOWN keys or the ENTER key in the keypad.

NAVIGATION KEYS



The navigation keys consist of 4 arrow keys which are used for navigation, alternatively to the rotary knob.

UP/ DOWN KEYS

The up and down arrow keys do the following:

- In a numeric edit dialog box, increase or decrease the instrument parameter.
- In a list, table, window or dialog box, scroll vertically.

LEFT/ RIGHT KEYS

The left and right arrow keys do the following:

- In an alphanumeric edit dialog box, move the cursor forward and back.
- In a list, table, window or dialog box, scroll horizontally.

2.1.7 Front Panel Connectors

The RF and LF output connectors and a connector for external modulation signals are located on the front panel.

MOD EXT



Input for external modulation signals.

LF



Output for internal LF modulation generator signal.

See also data sheet and [Chapter 5.5.1, "Overview of LF Generator"](#), on page 218, [Chapter 5.5.2, "LF Output"](#), on page 218.



RF 50 Ohm

Output for RF signal.

NOTICE! Maximum Input Levels. Do not overload the RF output.

The instrument is equipped with a reverse power protection that prevents the RF output against back feed, see [Chapter 5.3.5.7, "Reverse Power Protection"](#), on page 165. Nevertheless, the maximum permissible reverse power is specified in the data sheet.

Depending on the equipped frequency option, the RF output connectors vary.

RF Option		Microwave Option	
			
Frequency options	Connector type	Frequency options	Connector type
R&S SMB- B101	N female	R&S SMB-B112/-112L	test port adapter, PC 3.5 mm female
R&S SMB-B102		R&S SMB-B120/-B120L	
R&S SMB-B103		R&S SMB-B131	test port adapter, PC 2.92 mm female
R&S SMB-B106		R&S SMB-B140/-140L/-B140N	

NOTICE! Risk of RF connector and cable damage. Excessive tightening of the connectors can damage the cables and connectors. Too weak tightening leads to inaccurate results.

Always use an appropriate torque wrench suitable for this type of connector and apply the torque specified in the application note [1MA99](#).

The application notes are available on the Internet and provide additional information on care and handling of RF connectors.

Rohde & Schwarz offers appropriate torque wrenches for various connectors. For ordering information see the R&S SMB data sheet or product brochure.

2.2 Rear Panel Tour

This section gives an overview of connectors on the rear panel of the instrument. Each connector is briefly described and a reference is given to the chapters containing detailed information. For technical data of the connectors refer to the data sheet.



Figure 2-2: Rear panel view

2.2.1 Description of the Connectors



FUSES

The R&S SMB is fully fused by two fuses IEC60127-T3.15H/250 V.

The fuses are accommodated in the fuse holders next to the power connector. Use only fuses of the mentioned type.

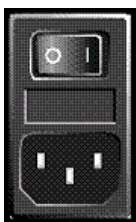

AC SUPPLY AND POWER SWITCH

When the R&S SMB is connected to the AC supply, it automatically sets itself to the correct range for the applied voltage (range: see type label). There is no need to set the voltage manually or change fuses.

The power switch can be set to two positions:

- **0**
The instrument is disconnected from the mains.
- **I**
The instrument is power-supplied. It is either ready for operation (STANDBY) or in operating mode, depending on the position of the ON/STANDBY switch on the instrument front.

See also data sheet and [Chapter 2.3.4, "Connecting the Instrument to the AC Supply"](#), on page 28.



USB IN

USB (universal serial bus) interface of type B (device USB).

This interface can be used for remote control of the instrument.



USB CONNECTORS TYPE A

USB (universal serial bus) interfaces of type A (host USB).

- Connection of peripherals such as mouse, keyboard, etc.
- Connection of memory stick for file transmission
- Firmware update

See also [Chapter 2.4.1, "Connecting USB Devices"](#), on page 32.



LAN CONNECTOR

Ethernet interface

- For integrating signal generators in a network
- Remote control of signal generator
- Remote access to the signal generator
- Firmware update

See also:

- [Chapter 2.6, "Setting Up a Network \(LAN\) Connection"](#), on page 34
- [Chapter 6.1.3, "LAN Interface"](#), on page 237

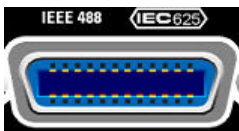

IEC 625/IEEE 488

IEC-bus (IEEE 488) interface for remote control of the instrument.

See also [Chapter A.1, "GPIB Bus Interface"](#), on page 490 and [Chapter 6.1.6, "GPIB Interface \(IEC/IEEE Bus Interface\)"](#), on page 241.

Note: In order to avoid electromagnetic interference (EMI) caused by open lines, always terminate any connected IEC-bus cable with an instrument or a controller.

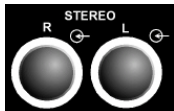

STEREO R/L

Inputs for analog stereo modulation signals. External modulation sources or the internal LF generator can be used (stereo modulation is available with option R&S SMB-B5).

See also [Chapter 5.4.6, "Stereo Modulation"](#), on page 211.



S/P DIF

Input for digital stereo signals (stereo modulation is available with option R&S SMB-B5).

See also [Chapter 5.4.6, "Stereo Modulation"](#), on page 211.



SIGNAL VALID

Output of valid signal. This signal marks the valid signal times (valid level and frequency indication). The signal is generated automatically.

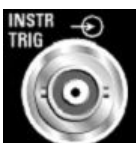

INSTR TRIG

Input for external trigger for sweeps and list mode.

See also [Chapter 5.3.7.4, "List Mode"](#), on page 187 and [Chapter 5.3.7.1, "Overview"](#), on page 174.



PULSE VIDEO

Output of internal pulse generator signal or external pulse signal fed in via the PULSE EXT connector (video signal).

See also [Chapter 5.4.5, "Pulse Modulation \(PM\)"](#), on page 209 .

**PULSE EXT**

Input of external pulse signal or input of external trigger/gate signal for internal pulse generator.

See also [Chapter 5.4.5, "Pulse Modulation \(PM\)"](#), on page 209 .

**REF OUT**

Output of internal reference signal.

See also [Chapter 5.3.4, "Reference Oscillator"](#), on page 141.

**REF IN**

Input for external reference signal.

See also [Chapter 5.3.4, "Reference Oscillator"](#), on page 141.

OCXO

- Oven-controlled reference oscillator (option R&S SMB-B1)
or
- high performance oven-controlled reference oscillator (option R&S SMB-B1H)

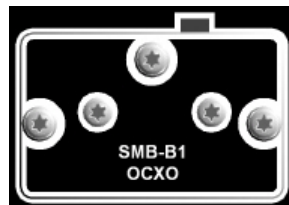

The OCXO generates a very precise 10 MHz reference signal. It needs some minutes of warm-up time to reach its nominal frequency.

Refer also to the data sheet for detailed information.

2.3 Putting into Operation

This section describes the basic steps to be taken when setting up the R&S SMB for the first time.

WARNING

Risk of injury and instrument damage

The instrument must be used in an appropriate manner to prevent electric shock, fire, personal injury, or damage.

- Do not open the instrument casing.
- Read and observe the "Basic Safety Instructions" delivered as a printed brochure with the instrument.

In addition, read and observe the safety instructions in the following sections.

Notice that the data sheet may specify additional operating conditions.

NOTICE**Risk of instrument damage**

Note that the general safety instructions also contain information on operating conditions that prevent damage to the instrument. The instrument's data sheet can contain additional operating conditions.

NOTICE**Risk of electrostatic discharge (ESD)**

Electrostatic discharge (ESD) can damage the electronic components of the instrument and the device under test (DUT). ESD is most likely to occur when you connect or disconnect a DUT or test fixture to the instrument's test ports. To prevent ESD, use a wrist strap and cord and connect yourself to the ground, or use a conductive floor mat and heel strap combination.

For details, refer to the basic safety instructions delivered as a printed brochure with the instrument.

NOTICE**Risk of instrument damage during operation**

An unsuitable operating site or test setup can damage the instrument and connected devices. Ensure the following operating conditions before you switch on the instrument:

- All fan openings are unobstructed and the airflow perforations are unimpeded. The minimum distance from the wall is 10 cm.
- The instrument is dry and shows no sign of condensation.
- The instrument is positioned as described in the following sections.
- The ambient temperature does not exceed the range specified in the data sheet.
- Signal levels at the input connectors are all within the specified ranges.
- Signal outputs are correctly connected and are not overloaded.

2.3.1 EMI Suppression

Electromagnetic interference (EMI) may affect the measurement results.

To suppress generated Electromagnetic Interference (EMI),

- Use suitable shielded cables of high quality. For example use double-shielded RF and LAN cables.
Note: USB cables are of varying and often poor quality. Therefore, check the quality of each individual USB cable as described in the service manual.
- Always terminate open cable ends.
- Note the EMC classification in the data sheet

2.3.2 Unpacking and Checking the Instrument

To remove the instrument from its packaging and check the equipment for completeness, proceed as follows:

1. Pull off the polyethylene protection pads from the instrument's rear feet.
2. Carefully remove the pads from the instrument handles at the front.
3. Pull off the corrugated cardboard cover that protects the rear of the instrument.
4. Carefully unthread the corrugated cardboard cover at the front that protects the instrument handles and remove it.
5. Check the equipment for completeness using the delivery note and the accessory lists for the various items.
6. Check the instrument for any damage. If there is damage, immediately contact the carrier who delivered the instrument. Make sure not to discard the box and packing material.



Packing material

Retain the original packing material. If the instrument needs to be transported or shipped at a later date, you can use the material to protect the control elements and connectors.

2.3.3 Placing or Mounting the Instrument

The R&S SMB is designed for use under laboratory conditions, either on a bench top or in a rack using a rack adapter kit (order number see data sheet).

Bench Top Operation

If the R&S SMB is operated on a bench top, the surface should be flat. The instrument can be used in horizontal position, standing on its feet, or with the support feet on the bottom extended.

⚠ CAUTION**Risk of injury if feet are folded out**

The feet may fold in if they are not folded out completely or if the instrument is shifted. This may cause damage or injury.

- Fold the feet completely in or completely out to ensure stability of the instrument. Never shift the instrument when the feet are folded out.
- When the feet are folded out, do not work under the instrument or place anything underneath.
- The feet can break if they are overloaded. The overall load on the folded-out feet must not exceed 500 N.

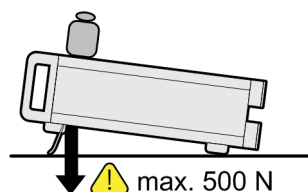
**⚠ CAUTION****Risk of injury and instrument damage if stacking instruments**

A stack of instruments may tilt over and cause injury. Furthermore, the instruments at the bottom of the stack may be damaged due to the load imposed by the instruments on top.

Observe the following instructions when stacking instruments:

- Never stack more than three instruments with the same dimensions (width and length). If you need to stack more than three instruments, install them in a rack.
- The overall load imposed on the lowest instrument must not exceed 500 N.
- All instruments should have the same dimensions (width and length). If you need to stack smaller instruments on the top, the overall load imposed on the lowest instrument must not exceed 250 N.
- If the instruments have foldable feet, fold them in completely.

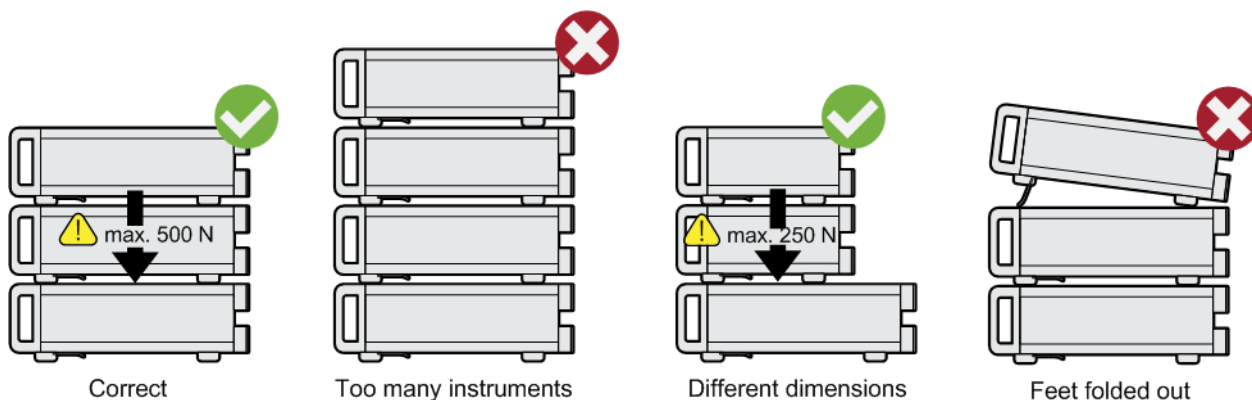

Rackmounting

The R&S SMB can be installed in a rack using a rack adapter kit (Order No. see data sheet). The installation instructions are part of the adapter kit.

NOTICE

Risk of instrument damage in a rack

An insufficient airflow can cause the instrument to overheat, which may disturb the operation and even cause damage.

Make sure that all fan openings are unobstructed, that the airflow perforations are unimpeded, and that the minimum distance from the wall is 10 cm.

2.3.4 Connecting the Instrument to the AC Supply

The R&S SMB is automatically adapted to the AC voltage supplied. There is no need to set the voltage manually or change fuses. The [AC SUPPLY AND POWER SWITCH](#) is at the rear of the unit.

- ▶ Connect the instrument to the AC power source using the AC power cable delivered with the instrument.

Note: The instrument is in compliance with safety class EN61010-1. Connect the instrument only to a socket with earthing contact.

2.3.5 Starting the Instrument



Switching off the AC power

You can leave the AC power on permanently to preserve your last instrument settings. Switching off is required only if the instrument must be completely disconnected from all power supplies.

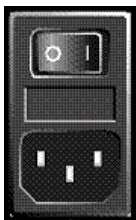

Starting up instruments with power switch

1. [Connect the instrument to the AC supply.](#)
2. To turn the power on, press the main power switch to position I (On).
After power-up, the instrument is in [standby or ready state](#), depending on the state of the ON/STANDBY key at the front panel of the instrument when the instrument was switched off for the last time.
3. In case the instrument is in standby mode, i.e. the yellow LED is on, press the ON/STANDBY key to switch the instrument to ready state.

2.3.5.1 Standby and Ready state

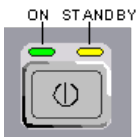

The ON/STANDBY key is located in the bottom left corner of the front panel.

Switching between standby and ready state

- ▶ Press the ON/STANDBY key briefly to switch the instrument from the standby to ready state or vice versa.

In ready state, the left, green LED is on. The instrument is ready for operation. All modules are power-supplied and the R&S SMB initiates its [startup procedure](#).

In standby state, the right, yellow LED is on. The standby power only supplies the power switch circuits and the oven-controlled crystal oscillator to keep it at its operating temperature. In this state it is safe to switch off the AC power and disconnect the instrument from the power supply.

2.3.5.2 Start Display and Booting

The instrument boots the operating system, starts the instrument firmware and automatically performs a selftest. If the previous session was terminated regularly, the instrument uses the last setup with the relevant instrument settings.

Once the startup procedure has been terminated, the block diagram opened in the previous session is displayed and the instrument is ready for operation.



Use the PRESET key to return the instrument to its definite reset/preset state, if the current setup is not anymore relevant.

To customize the start settings, use the "File" dialog.



Rebooting the instrument

Press the STANDBY key for approx. 5 s. to reboot the instrument, if the software stops unexpectedly.

2.3.5.3 Function Check

The signal generator automatically monitors the main functions when the instrument is switched on and continuously during operation.

A detected fault is indicated by a "ERROR" message displayed in the info line together with a brief error description. For in-depth identification of the error, press the INFO key. In response, a description of the error(s) is displayed.

For more information, refer to [Chapter 9, "Status Information, Error Messages and Troubleshooting"](#), on page 481.

Additionally to the automatic monitoring, the R&S SMB offers the following capabilities to ensure correct functioning:

- Internal Adjustments

Press the SETUP key and select "System > Internal Adjustments" to access the dialog for performing and configuring of the adjustments settings. A maximum level accuracy can be obtained, for instance.

- Selftest
A selftest is provided for service purposes.

2.3.5.4 Default Settings

When the instrument is switched on, it is not the preset state that is active, but rather the instrument state that was set before the instrument was switched off. It is also recommended that you use the PRESET key to return the instrument to its defined preset state every time a new configuration is required or the current setup is not anymore relevant.

The R&S SMB offers a two-stage preset concept:

- Preset the instrument to a predefined state
The PRESET key calls up a defined instrument setup. All parameters and switching states are preset (also those of inactive operating modes). The default instrument settings provide a reproducible initial basis for all other settings. However, functions that concern the integration of the instrument into a measurement setup are not changed, e.g. GPIB bus address or reference oscillator source settings.
- Preset the instrument to its factory settings
The instrument can also be forced to load its default factory settings. To access the corresponding dialog box, press the SETUP key and select the "Factory Preset". For more information and an overview of the settings affected by the factory preset function, see [Chapter 5.2.3.20, "Factory Preset"](#), on page 120.

Overview of the Most Important Preset States

The following list gives an overview of the presets for the most important generator settings. The other presets can be found in the preset tables of the individual menus and the information accompanying the remote commands.

- "RF frequency" = 1 GHz
- "RF level" RF output switched off
- "Level" = 30 dBm for instruments including an attenuator
"Level" = -5 dBm for instruments with no attenuator
- "Offsets" = 0
- "Modulations State" = Off
- Uninterrupted level settings are switched off
"Level Attenuator Mode" = AUTO
- Internal level control "Level ALC" = AUTO
- User correction "Level Ucor" = OFF
- "LF output State" = Off
- "Sweep State" = Off

Settings that are not affected by the PRESET key

- Reference frequency settings ("Ref Oscillator" menu)

- Power on settings ("Level/EMF" menu)
- Network settings ("Setup" menu)
- GPIB address ("Setup" menu)
- *IDN? Identification and emulation ("Setup" menu)
- Password and settings protected by passwords ("Setup" menu)
- Start/Stop Display Update ("Setup" menu)
- Display and keyboard settings ("Setup" menu)



User-defined instrument states can be stored and called up in the "File" dialog.

2.3.6 Shutting Down the Instrument

To shut down the R&S SMB, proceed as described below.

NOTICE

Risk of losing data

If you switch off the running instrument using the rear panel switch or by disconnecting the power cord, the instrument loses its current settings. Furthermore, program data may be lost.

Press the ON/STANDBY key first to shut down the application properly.

1. Press the ON/STANDBY key to save the current setup, shut down the operating system and set the instrument to standby state.
The yellow LED must be on.
2. To switch off the power, press the main power switch to position 0 (Off).
None of the front-panel LEDs should be on.

2.3.7 Power Fuses

The R&S SMB is fully fused by two fuses IEC60127-T3.15H/250 V.

The fuses are accommodated in the fuse holders next to the power connector. Use only fuses of the mentioned type.

⚠ WARNING**Shock hazard**

Before replacing a fuse, make sure that the instrument is switched off and disconnected from all power supplies.

Always use fuses supplied by Rohde & Schwarz as spare parts, or fuses of the same type and rating.

2.4 Connecting External Accessories

The equivalent USB ports on the front and/or rear panel of the R&S SMB can be used to connect a variety of accessories.

In addition the instrument provides interfaces for network integration (see [Chapter 2.6, "Setting Up a Network \(LAN\) Connection"](#), on page 34).

2.4.1 Connecting USB Devices

Via the USB ports, you can connect external devices directly to the R&S SMB. If you need more interfaces, you just use an USB hub.

The following list shows various USB devices that can be useful:

- Memory stick for easy transfer of data to/from a computer (for example firmware updates).
- CD-ROM drives for easy installation of firmware applications.
- Keyboard or mouse to simplify the entry of data, comments, file names, etc.
- Power sensors, for example of the NRPxS(N) Power Sensors family.

Installing USB devices is easy under Linux, because all USB devices are plug&play. After a device is connected to the USB interface, the operating system automatically searches for a suitable device driver.

If Linux does not find a suitable driver, it will prompt you to specify a directory that contains the driver software. If the driver software is on a CD, connect a USB CD-ROM drive to the instrument before proceeding.

When a USB device is subsequently disconnected from the R&S SMB, the operating system immediately detects the change in hardware configuration and deactivates the corresponding driver.

All USB devices can be connected to or disconnected from the instrument during operation.

Connecting a memory stick or CD-ROM drive

If installation of a memory stick or CD-ROM drive is successful, the operating system informs you that the device is ready to use. The device is made available as a new drive (`/usb`). The name of the drive is manufacturer-dependent.

Connecting a keyboard

The keyboard is detected automatically when it is connected. The default keyboard layout is English – US.

Use the "Setup > Keyboard Settings" dialog to configure the keyboard properties.

Connecting a mouse

The mouse is detected automatically when it is connected.

2.5 Linux Operating System

The instrument uses an embedded Linux operating system. To make sure that the instrument software works properly, certain rules must be adhered to concerning the operating system.

NOTICE

Risk of causing instrument unusability

The instrument is equipped with the Linux operating system. Additional software can therefore be installed on the instrument. The use and installation of additional software may impair instrument function. Thus, run only programs that Rohde & Schwarz has tested for compatibility with the instrument software.

The drivers and programs used on the instrument under Linux have been adapted to the instrument. Existing instrument software must always be modified using only update software released by Rohde & Schwarz.

The configuration of the operating system is optimally adapted to signal generator functions in the factory. Changes in the system setup are only required when peripherals like keyboard are installed or if the network configuration does not comply with the default settings (see [Chapter 2.6.1, "Connecting the Instrument to the Network"](#), on page 35). After the R&S SMB is started, the operating system boots and the instrument firmware is started automatically.



Accessing Operating System

No access to the operating system is required for normal operation.

All necessary system settings can be made in the "Setup" dialog.

The R&S SMB provides an internal flash memory, it does not contain a disk drive. The flash memory holds the operating system, the firmware and the stored data. Data transfer is possible via a memory stick connected to a USB interface. The memory stick and the flash memory are accessed via the "File Manager".

Accessing the File System

The instrument also supports two standard methods to access the file system from a remote client:

- FTP (file transfer protocol)
- File sharing according to the SAMBA/SMB (server message block) protocol.

Both methods allow the access to the folder `/var/user/share`.



Default password

The FTP and SAMBA/SMB file access use the user "instrument" with the default password "instrument".

It is highly recommended that you change this password in the [Chapter 5.2.3.18, "Security"](#), on page 114 dialog before connecting the instrument to the network!

Refer also to Application Note 1GP72 "Connectivity of Signal Generators", provided on the Rohde & Schwarz website, at <http://www.rohde-schwarz.com/appnotes>.

Screen saver

A screen saver can be activated in the R&S SMB. When active, the display is shut off when no entries via front panel, external mouse or external keyboard are made for a period of time. The screen saver prolongs the life time of the display.

Use the "Setup > Display Settings" dialog to switch on or off the screen saver and to adjust the screen saver settings.

2.6 Setting Up a Network (LAN) Connection

The R&S SMB is equipped with a network interface and can be connected to an Ethernet LAN (local area network). Provided the appropriate rights have been assigned by the network administrator and the Linux firewall configuration is adapted accordingly, the interface can be used, for example:

- To transfer data between a controller and the instrument, e.g. in order to run a remote control program.
See [Chapter 6, "Remote Control Basics"](#), on page 235.
- To access or control the measurement from a remote computer using the R&S VISA or Ultr@VNC programs (or similar tools, like another VNC client or any Web browser supporting Java)
- To transfer data from a remote computer and back, e.g. using network folders

This section describes how to configure the LAN interface. It includes the following topics:

- [Chapter 2.6.1, "Connecting the Instrument to the Network"](#), on page 35
- [Chapter 2.6.2, "Assigning the IP Address"](#), on page 36



Accessing Operating System

No access to the operating system is required for normal operation.
All necessary system settings can be made in the "Setup" dialog.

2.6.1 Connecting the Instrument to the Network

There are two methods to establish a LAN connection to the instrument:

- A non-dedicated network (Ethernet) connection from the instrument to an existing network
- A dedicated network connection (Point-to-point connection) between the instrument and a single computer

In both cases, an IP address has to be assigned to the instrument and the computer, which is usually accomplished automatically. See also [Chapter 2.6.2, "Assigning the IP Address"](#), on page 36.

To set up a network (LAN) connection

NOTICE

Risk of network failure

Before connecting the instrument to the network or configuring the network, consult your network administrator. Errors may affect the entire network.

- ▶ Connect the instrument to the network or to a single PC.

If the instrument is connected to the LAN, the operating system automatically detects the network connection and activates the required drivers.

By default, the instrument is configured to use dynamic TCP/IP configuration and obtain all address information automatically.

The network card can be operated with a 10/100 Mbps Ethernet IEEE 802.3u interface.

NOTICE

Risk of network connection failure

Network cables and cable connectors of poor quality may cause network connection failures.

If the network connection to the instrument fails, check the network infrastructure and contact your network administrator.

For details, see section "Status Information, Error Messages and Troubleshooting".

2.6.2 Assigning the IP Address

Depending on the network capacities, the TCP/IP address information for the instrument can be obtained in different ways.

- If the network supports dynamic TCP/IP configuration using the Dynamic Host Configuration Protocol (DHCP), all address information can be assigned automatically.
- If the network does not support DHCP, the instrument tries to obtain the IP address via Zeroconf (APIPA) protocol. If this attempt does not succeed or if the instrument is set to use alternate TCP/IP configuration, the addresses must be set manually.

By default, the instrument is configured to use dynamic TCP/IP configuration and obtain all address information automatically. This means that it is safe to establish a physical connection to the LAN without any previous instrument configuration.

NOTICE

Risk of network errors!

Connection errors can affect the entire network.

If your network does not support DHCP, or if you choose to disable dynamic TCP/IP configuration, you must assign valid address information before connecting the instrument to the LAN.

Contact your network administrator to obtain a valid IP address.

Assigning the IP address on the instrument

1. Press the SETUP key and select the "Network Settings" dialog.
2. Set the "Address Mode" to Static.
3. Select the "IP Address" and enter the IP address, for example *192.168.0.1..*
The IP address consists of four number blocks separated by dots. Every block contains 3 numbers in maximum.
4. Select the "Subnet Mask" and enter the subnet mask, for example *255.255.255.0.*
The subnet mask consists of four number blocks separated by dots. Every block contains 3 numbers in maximum.



Use computer names to identify the instrument

In networks using a DHCP server, it is recommended that you address the instrument by its unambiguous computer name, see [Chapter 2.6.3, "Using Computer Names"](#), on page 37.

A computer name (*hostname*) is an unique dedicated identification of the instrument, that remains permanent as long as it is not explicitly changed. Hence, you can address an instrument by the same identification (computer name), irrespectively if a network or a point-to-point connection is used.

To assign the IP address manually on the remote computer

- ▶ Obtain the necessary information from your network administrator. If you use more than one LAN connector, you need separate address information for each connector.

For information on how to perform the configurations, refer to the documentation of the operating system the remote computer uses.

2.6.3 Using Computer Names

In a LAN that uses a DNS server (Domain Name System server), each PC or instrument connected in the LAN can be accessed via an unambiguous computer name instead of the IP address. The DNS server translates the host name to the IP address. This is especially useful when a DHCP server is used, as a new IP address may be assigned each time the instrument is restarted.

Each instrument is delivered with an assigned computer name, but this name can be changed.

The default instrument name is a non-case-sensitive string that follows the syntax `rs<instrument><serial number>`.

The serial number can be found on the rear panel of the instrument. It is the third part of the device ID printed on the bar code sticker:



Querying and changing a computer name

1. Press the "Setup" key and select "Network Settings".
The computer name is displayed under "Hostname".
2. Press the "Setup" key, select "Protection" and enable the "Protection Level 1".
The default password is 123456.
The parameter "Hostname" in the "Network Settings" dialog is now enabled for configuration.
3. Change the "Hostname".

2.7 Remote Access via an External Controller

The R&S SMB can be remote accessed from a remote computer (external controller) via a network link. This allows convenient operation of the instrument from the desktop although the instrument is integrated in a rack somewhere else.



For an overview of the instrument's operating concept and the different ways to control and operate the instrument, see [Chapter 3.1, "Brief Introduction to the Instrument's Concept"](#), on page 54.

There are different ways to establish a remote access connection to the signal generator but all of them require an established LAN connection between the instrument and the remote computer. The simplest way to remote access the instrument is to use a Web browser, such as Windows Internet Explorer or Mozilla Firefox for instance. Alternatively a remote access via a special application can be used.

For example, the free-of-charge program Ultr@VNC for PCs with Linux/Unix or Windows operating system is available for setting up the remote access connection. Using this application requires additional installation.

See the following table for an overview of the different ways to establish a remote access connection to the signal generator.

Table 2-1: Remote access via an external computer

Remote access via	LAN connection	Installation of the additional application	
		on the instrument	on the remote computer
Any web browser for example Windows Internet Explorer or Mozilla Firefox, see Chapter 2.7.1, "Using a Web Browser for Remote Access" , on page 39	required	no	<i>Java Runtime</i> must be installed and activated in the browser settings.
Web browser with HTML5 for example LXI Browser, see Chapter 2.8.2.4, "Web Control" , on page 50	required	no	<i>Web sockets</i> must be supported.
VNC Client for example Ultr@VNC or other dedicated client software for PCs with Linux/Unix or Windows operating system see Chapter 2.7.2, "Remote Access via a VNC Client Software" , on page 40	required	required	VNC Viewer required

When the connection is set up with a VNC client software (Ultr@VNC), direct control on the instrument is possible while remote access is established.

For return to direct operation on the instrument, the connection must be cut. After cutting the connection, it is still enabled and can be established again any time. The connection is disabled only after deactivation of the program.

This section gives an information on how to use the Web browser for remote access, how to install the applications for remote access and how to establish the connection between the instrument and an external computer with Windows operating system. Remote access via an external computer with Linux/Unix operating system is performed accordingly.



Default password

Remote-access and file access require the user "instrument" with default password "instrument".

NOTICE

Changing the default user and security passwords

It is highly recommended to change the default user and security passwords in the menu "Setup > Security" before connecting the instrument to the network (see section [Chapter 5.2.3.18, "Security"](#), on page 114).

2.7.1 Using a Web Browser for Remote Access

The instrument can be remote-accessed via any web browser, as for example the Windows Internet Explorer or Mozilla Firefox.



Alternatively, you can also make use of the LXI browser, as described in [Chapter 2.8.2.4, "Web Control"](#), on page 50.

To remote access the instrument via a web browser:

1. Connect the instrument and the remote computer to a LAN, see [Chapter 2.6.1, "Connecting the Instrument to the Network"](#), on page 35.
2. Instal the Java Runtime Environment JRE on the remote computer.
3. Type the instruments' IP address in the address field of the Web browser on your PC, e.g. `http://10.111.11.1`

The "VNC Authentication" screen appears.

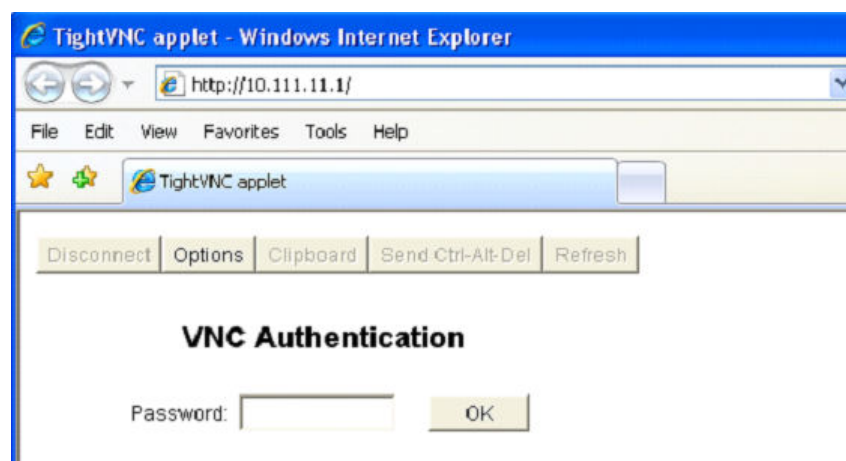

4. Enter the password and select "OK".

The default password is "instrument".

After the connection is established, the current signal generator screen with the block diagram is displayed and the instrument can be remote-accessed from the remote computer.

2.7.2 Remote Access via a VNC Client Software

A VNC client software is an application which can be used to access and control the instrument from a remote computer via LAN.

The following description explains how to establish the remote access, represented by means of the client software Ultr@VNC. The software is included in Linux/Unix operating system, but it is also available as a free-of-charge download on the Internet <http://www.uvnc.com/download/index.html>. Thus, it is also available for remote computers with Windows operating system.



The GUI appearance of Ultr@VNC may vary if you use a later release. Also, similar programs may deviate in some details, but the basic procedure is the same.

NOTICE

Risk of Unauthorized Access

If the VNC service is enabled on the instrument, any user in the network who knows the computer name and password can access it.

Disable the VNC service on the instrument to prevent unauthorized access.

See "[LAN Services](#)" on page 116.

Setting up a VNC connection

1. Connect the instrument and the remote computer to a LAN, see [Chapter 2.6.1, "Connecting the Instrument to the Network"](#), on page 35.
2. [Install the Ultr@VNC application](#) and enable it on the instrument.
3. In the ICF firewall, enable communication on the network via Ultr@VNC program.
4. Install the VNC Viewer on the remote computer with Windows operating system, see "[Installing the VNC Viewer on a Windows PC](#)" on page 42.
5. Set up the VNC connection between the instrument and:
 - a) the remote computer with Linux/Unix operating system, see "[Setting up the VNC connection on the Linux/Unix remote computer](#)" on page 43;
 - b) the remote computer with Windows operating system, see "[Setting up the VNC connection on the Windows remote computer](#)" on page 43.



Enabled Direct Control

The direct control of the instrument is not disabled and the instrument can be controlled from the front panel and via the remote computer alternately.

Installing the Ultr@VNC application

1. Download the program from the internet and copy it to a directory that can be accessed.
2. On the instrument, shut down firmware using the ALT+F4 key combination.
3. Double click on the setup file to start the installation.
The setup wizard leads through the installation. This description focus only on the relevant settings.
 - a) Select installation of all components.

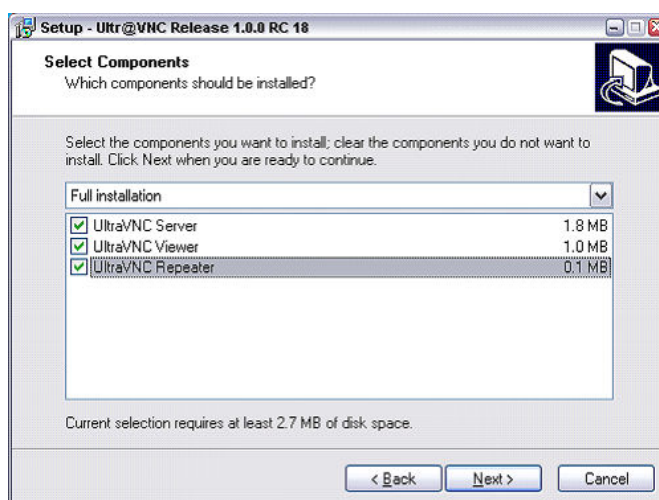

- b) In the "Additional Task Panel", enable all entries.

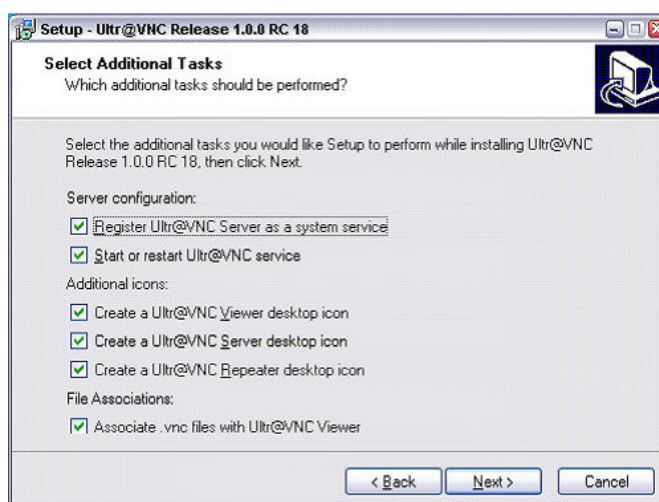

A successful installation is indicated by a message.

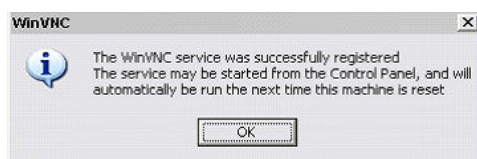

At the same time a warning is displayed stating that a password must be set.

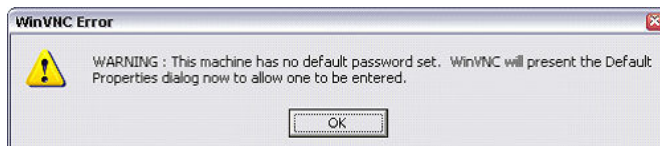

4. Select "OK".

The "Default Local System Properties" panel opens.

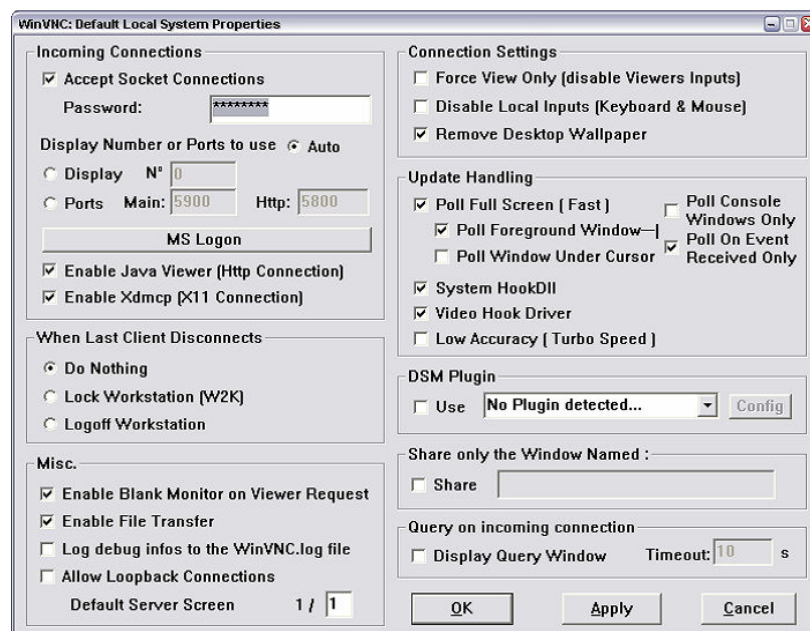

5. Enter a password with a length of at least five digits.

This password is used on the remote computer to access the instrument. Other settings may be changed according to the user-specific security requirements.

After the installation the Ultr@VNC program is automatically started together with the operating system. On mouse over, the IP address of the instrument is indicated.

This IP address and the user-defined password are the prerequisites to enable remote access on the remote computer. Terminated connection is indicated by changed icon color.

Installing the VNC Viewer on a Windows PC

1. Download the Ultr@VNC program from internet and follow the installation instructions.

Only the program component VNC Viewer is required.

Note: The VNC Viewer program is included in the download for the installation of the Ultr@VNC program on the signal generator if "Full installation" was selected in the "Select Component" panel. In this case, the program `ultr@vncviewer.exe` can be copied to the Windows PC.

2. Install VNC Viewer program component on the remote computer.

Setting up the VNC connection on the Linux/Unix remote computer

The VNC program is available per default for Linux/Unix operating systems.

1. Start a Web browser on the remote computer and enter the IP address of the instrument.
2. Enter the following address:
`vnc://<IP-address of the instrument>`, e.g. `vnc://192.168.1.1`.

A dialog is opened and the password for the remote VNC connection is requested.

3. Enter the password as defined in the "Default Local System Properties" panel of the Ultr@VNC program and select "Log On".

The connection is established, the instrument is remote accessed and the current signal generator screen with the block diagram is displayed. The individual functions are operated using the mouse and keyboard.

In contrast to remote access via Remote Desktop, the direct control of the instrument is not disabled and the instrument can be controlled from the front panel and via the remote computer alternately.

Setting up the VNC connection on the Windows remote computer

1. Start VNC Viewer program component on the PC, select "VNC Server" and enter IP address of the instrument.

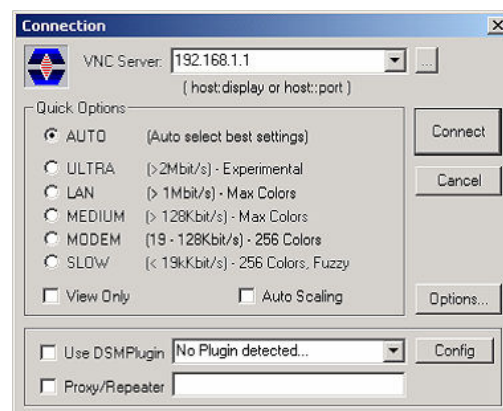

2. To initialize the connection, select "Connect".
A message requesting the password appears.

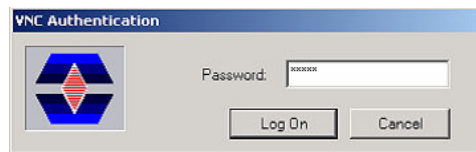

3. Enter the password as defined in the "Default Local System Properties" panel of the Ultr@VNC program and select "Log On".

The connection is established, the instrument is remote accessed and the current signal generator screen with the block diagram is displayed. The individual functions are operated using the mouse and keyboard.



Enabled Direct Control

The direct control of the instrument is not disabled and the instrument can be controlled from the front panel and via the remote computer alternately.

Terminating VNC Connection

The remote access via VNC connection can be terminated either on the R&S SMB or on the external PC. Terminating the connection does not disable it. It can be established again any time. See the notice above concerning unauthorized access due to VNC connection!

1. Terminate the connection on the R&S SMB
 - a) Press the "Windows" key to access the operating system.
 - b) Right-click on the VNC icon on the task bar and select "Kill all clients".
2. To terminate the connection on the external Linux/Unix PC, close the internet browser or close the signal generator window.
3. To terminate the connection on the external Windows PC, close the VNC Viewer program.

The connection is terminated. The color of the VNC icon in the status bar of the instrument changes.

A message on the external PC indicates the disconnection.

Disabling Remote Access via Ultr@VNC

The VNC connection can be disabled by removing the program on the instrument or by deactivating the VNC Server service.

1. Remove the VNC program
 - a) Press the "Windows" key to access the operating system and open the "Add or Remove Programs" by selecting "Start > Settings > Control Panel > Add or Remove Programs".
 - b) Remove the VNC program.
2. Deactivate the VNC Server service
 - a) Press the "Windows" key to access the operating system and open the "Services" by selecting "Start > Settings > Control Panel > Services".

b) Deactivate the VNC Server service.

The connection is disabled, the VNC icon disappears from the task bar of the instrument.

2.8 LXI Configuration

LXI ("LAN eXtensions for Instrumentation" is an instrumentation platform for measuring instruments and test systems that is based on standard Ethernet technology. LXI is intended to be the LAN-based successor to GPIB, combining the advantages of Ethernet with the simplicity and familiarity of GPIB.

Like GPIB, LXI determines and standardizes the way the instrument behaves in a LAN. The LXI implementation by the Rohde&Schwarz signal generators allows you to change certain LAN settings, to reset the LAN connection as well as to identify the instrument easily.



For information about the LXI standard, refer to the LXI website at <http://www.lxistandard.org>. See also "News from Rohde & Schwarz, article 2006/II - 190".

The R&S SMB provides an integrated "LXI Status" dialog for LXI status indication and reset of the LAN configuration ("LAN Configuration Initialize", LCI). To access the LXI status dialog, press the SETUP key and select "Remote > LXI Status".

For further information, see [Chapter 5.2.3.16, "LXI Status"](#), on page 112.



Firmware update

After a firmware update, shut down and restart the instrument in order to enable the full LXI functionality.

Default state of the network settings

According to the LXI standard, an LCI must set the following parameters to a default state.

Parameter	Value
TCP/IP Mode	DHCP + Auto IP Address
Dynamic DNS	Enabled
ICMP Ping	Enabled
Password for LAN configuration	LxiWebIfc

The LCI for the R&S SMB also resets the following parameters:

Parameter	Value
Hostname	<Instrument-specific host name>
Description	Vector Signal Generator
Negotiation	Auto Detect
VXI-11 Discovery	Enabled

The LAN settings are configured using the instrument's "LXI Browser Interface".

2.8.1 LXI Browser Settings

To access the instrument via the web browser:

- ▶ Type in the instrument's host name or IP address in the address field of the browser on your PC, for example "http://10.113.1.205".
Note: Do not add the missing zeros in the IP address, while opening the instrument home page.

The instrument home page (welcome page) opens.

The screenshot shows the LXI Browser Interface. The top header features the Rohde & Schwarz logo and the LXI logo. The left navigation pane is organized into sections: LXI (Home, Lan Configuration, Status, Utilities), Instrument Control (Web Control, File Download, File Upload), Diagnostics (Device Screenshot, SCPI Remote Trace, SCPI Command Shell), and Help (Glossary, www.rohde-schwarz.com). The main content area is titled 'Instrument Properties' and lists the following information:

Instrument Model	R&S SMB
Manufacturer	Rohde & Schwarz GmbH & Co. KG
Serial Number	100011
Description	Rohde & Schwarz Signal Generator SMB100A 100011
LXI Version	1.4 LXI Core 2011
LXI Extended Features	
DNS Host Name(s)	instrument
MAC Address	00:25:64:C3:31:82
IP Address	10.113.1.150
Firmware Revision	03.20.390.12
Current Time	Wednesday, 2015/12/02, 11:54:06
Current Time source	Operating System
VISA resource string	TCPIP::10.113.1.150::inst0::INSTR TCPIP::10.113.1.150::hislip0::INSTR
Device Indicator	ACTIVE (press to toggle) ●

At the bottom of the main content area, there is a 'Status' section indicating 'No error'. The footer contains the copyright notice: © 2015 ROHDE&SCHWARZ. All rights reserved.

The navigation pane of the browser interface contains the following elements:

- "LXI"
 - "Home" opens the instrument home page.

The home page displays the device information required by the LXI standard, including the VISA resource string in read-only format.

- "Device Indicator" activates or deactivates the LXI status indication. When activated, the LXI LEDs flash, both in the browser dialog and in the LXI dialog of the connected instrument. A green LXI status symbol indicates that a LAN connection has been established; a red symbol indicates that no LAN cable is connected.
 - "Lan Configuration" allows you to configure LAN parameters and to initiate a ping, see [Chapter 2.8.2.3, "Ping Client"](#), on page 49.
 - "Status" displays information about the LXI status of the instrument.
 - "Utilities" provides access to the LXI event log functionality required by the LXI standard.
 - "Instrument Control"
 - "Web Control" provides remote access to the instrument, see [Chapter 2.8.2.4, "Web Control"](#), on page 50.
 - "Diagnostics"
 - "SCPI Remote Trace" records messages exchanged via the remote control interface, see [Chapter 2.8.2.5, "SCPI Remote Trace"](#), on page 51.
 - "Help"
 - "Glossary" explains terms related to the LXI standard.
 - www.rohde-schwarz.com opens the Rohde & Schwarz home page.
- ▶ Press the "INACTIVE (press to toggle)" button to activate the connection.

ACTIVE (press to toggle)



A green flashing status LED indicates the active connection. If the LAN connection fails, the LED turns red.

The status of the LAN connection is also indicated by the "LAN Status indicator" in the "LXI Status" dialog.

For further information, see section "LXI Status" in the Operating Manual.

2.8.2 LAN Configuration

The "LAN Configuration" web page provides access to the parameters required for identifying the R&S SMB in the network, and allows modification.



Password protection

Changing the LAN configuration is password-protected. The default password is *Lxi-WebIfc* (notice upper and lower case characters). This password cannot be changed in the current firmware version.

It comprises the following navigation entries.

- [IP Configuration](#)..... 48
- [Advanced LAN Configuration](#).....48
- [Ping Client](#).....49
- [Web Control](#)..... 50
- [SCPI Remote Trace](#).....51

2.8.2.1 IP Configuration

The "IP Configuration" page displays all mandatory LAN parameters.

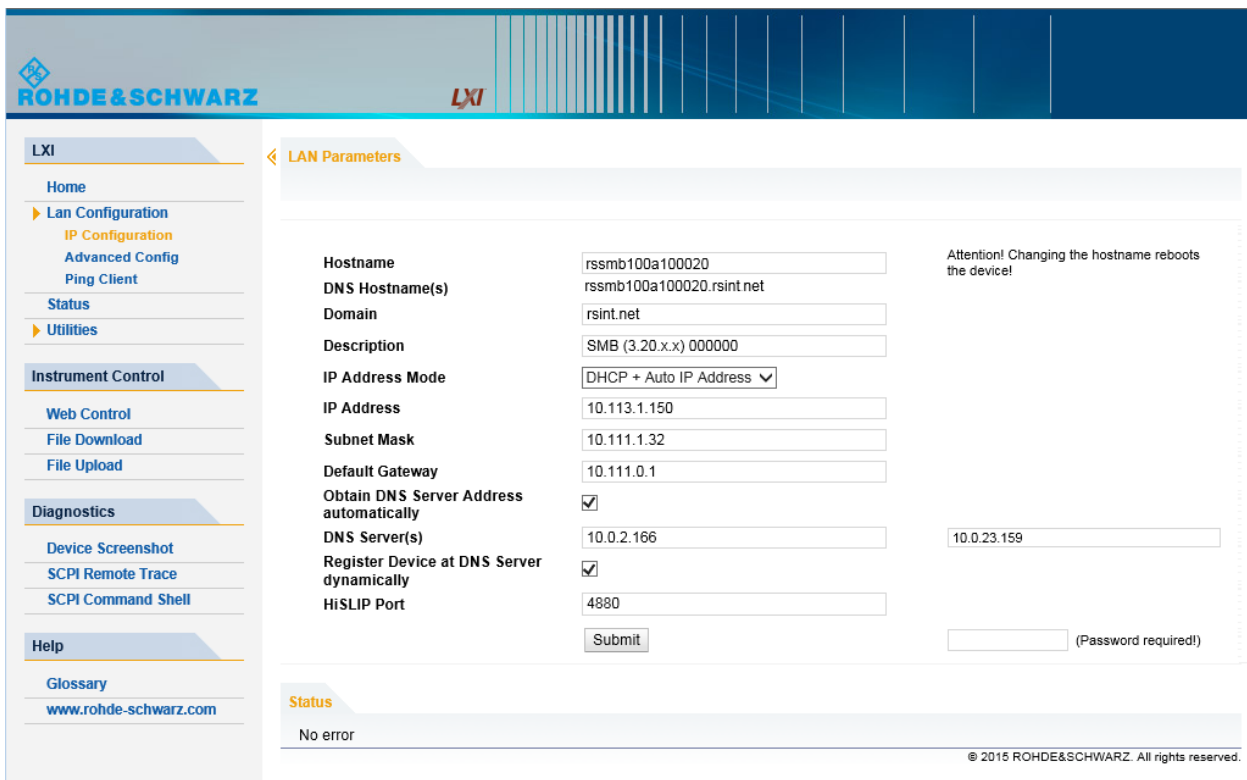

The "IP Address Mode" selects a configuration mode for the IP address of the R&S SMB. With static configuration, the entered IP address, subnet mask, and default gateway are used. With dynamic configuration, DHCP or dynamic link local addressing (automatic IP) are used to obtain the instrument IP address.

See [Chapter 2.6.2, "Assigning the IP Address"](#), on page 36.

2.8.2.2 Advanced LAN Configuration

The "Advanced Config" page provides LAN settings that are not declared mandatory by the LXI standard.

The screenshot shows the LXI configuration web interface. The top navigation bar includes the Rohde & Schwarz logo and the LXI logo. The main content area is titled "LAN Parameters" and contains the following settings:

- mDNS and DNS-SD**: A dropdown menu set to "mDNS & DNS-SD".
- ICMP Ping enabled**: A checked checkbox.
- VXI-11 Discovery**: A checked checkbox.
- A **Submit** button and a password input field with the label "(Password required!)" next to it.

On the left side, there is a navigation menu with the following items:

- LXI**
 - Home
 - Lan Configuration
 - IP Configuration
 - Advanced Config
 - Ping Client
 - Status
 - Utilities
- Instrument Control**
 - Web Control
- Diagnostics**
 - SCPI Remote Trace
- Help**
 - Glossary
 - www.rohde-schwarz.com

At the bottom of the page, there is a "Status" section indicating "No error" and a copyright notice: "© 2015 ROHDE&SCHWARZ. All rights reserved."

The following advanced parameters are available:

- "mDNS and DNS-SD": The additional protocols "multicast DNS" and "DNS service discovery" are used for device communication in zero configuration networks, working without DNS and DHCP.
- "ICMP Ping enabled": Must be enabled to use the ping utility. If you disable this setting, the instrument does not answer ping requests. The setting does not affect the LXI ping client. You can ping other hosts from the instrument, even if the setting is disabled.
- "VXI-11 Discovery": Must be enabled to detect the instrument in the LAN. If you disable this setting, the instrument cannot be detected by the VXI-11 discovery protocol mechanism. The setting does not affect other detection mechanisms. Setting up a VXI-11 connection via the IP address or the host name is independent of this setting.

2.8.2.3 Ping Client

The "Ping Client" page provides the ping utility to verify the connection between the LXI-compliant instrument and another device.

The ping is initiated from the instrument. Using the `ICMP` echo request and echo reply packets, the function checks whether the communication with a device via LAN works. Ping is useful for the diagnosis of IP network or router failures.

The ping utility is not password-protected.

To initiate a ping from the instrument to the device:

1. Enable "ICMP Ping" on the "Advanced LAN Configuration" page.
2. Select the "Ping Client" page.
3. In the "Destination Address" field, enter the IP address of the device you want to ping (without the ping command and without any further parameters), e.g. *10.113.1.203*.
4. Select "Submit".

The screenshot displays the LXI web interface for the R&S SMB100A. The left sidebar contains a navigation menu with the following items: LXI, Home, Lan Configuration, Status, Utilities, Instrument Control, Web Control, Diagnostics, SCPI Remote Trace, and Help. The main content area is titled 'Ping Parameter' and features a 'Destination Address' input field with 'Clear' and 'Submit' buttons. Below this, the 'Result' section shows the output of a ping command: 'PING 10.111.1.32 (10.111.1.32): 56 data bytes 64 bytes from 10.111.1.32: seq=0 ttl=64 time=0.280 ms --- 10.111.1.32 ping statistics --- 1 packets transmitted, 1 packets received, 0% packet loss round-trip min/avg/max = 0.280/0.280/0.280 ms'. At the bottom, a 'Status' section indicates 'No error'. The footer of the page reads '© 2015 ROHDE&SCHWARZ. All rights reserved.'

2.8.2.4 Web Control

The web control functionality provides remote operation via VNC using a Web browser (with HTML5). This mode does not require additional installation or activation. The VNC protocol allows simultaneous operation from several remote devices. The instrument remains locally operable.

The GUI of the R&S SMB is visible. To perform the settings, you can operate the instrument as with the manual control. The instrument controls are available via the front panel simulation. File upload and download between the instrument and the remote PC is also available.

Starting a Remote Control via the LXI web browser

This section assumes that the instrument and the controller PC are connected in the LAN.

1. Start a web browser that supports html5 (W3C compliant).
2. Enter the IP address of the R&S SMB in the browser's address bar.
The R&S SMB's welcome page is displayed.
3. In the navigation pane, select "Instrument Control" > "Web Control".
Remote access to the instrument requires the password. The default password is *instrument*.
4. Enter the password.
5. Confirm with the ENTER key.

After the connection is established, the current screen of the R&S SMB is displayed in the browser window.

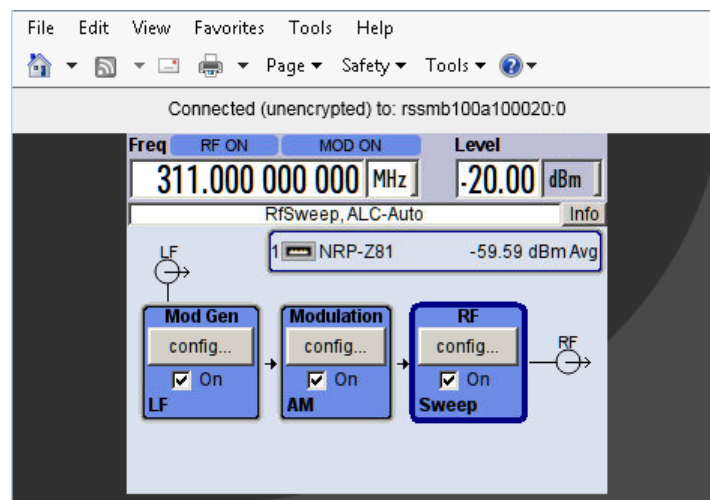

6. Use the mouse cursor and keyboard to access the functionality of the instrument as you would directly perform the settings on the instruments front panel.

2.8.2.5 SCPI Remote Trace

The remote trace functionality allows you to trace input and output strings at the remote control interface of the R&S SMB.

A recorded trace (message log) can be evaluated directly in the dialog. Use the highlighting and navigation functions provided in the lower toolbar to locate error messages and messages containing arbitrary search strings. You can also export the message log to a *.CSV file and evaluate the file using a suitable program.

To trace and display messages:

1. In the navigation pane, select "Diagnostics" > "SCPI Remote Trace".

- In the toolbar bar of the "SCPI Remote Trace" page, select "live mode" > "on" and "logging" > "on".
"live mode > on" displays all commands and responses, and "logging > on" also traces messages.
- If you now control the R&S SMB with SCPI commands, using an appropriate tool, the SCPI remote trace records the information sent and received.

rec	MT	I	message
0	>	1	*idn?
0	<	1	Rohde&Schwarz,<instrument,12345,67890>
0	>	1	*opt?
0	<	1	0
0	>	1	Freq?
0	<	1	1000000000
0	>	1	LEV -20
0	>	1	LEV?
0	<	1	-20

Status
20 live records received

© 2015 ROHDE&SCHWARZ. All rights reserved.

The function records all sent commands, received responses and messages, and stores them in an internal database. If "live mode" is disabled, you can display the recent traces upon request, using the "refresh" button. You can also store the log in a file.

Note: The diagnostics functionality is extended in later releases, e.g. to download or upload SCPI command files from / to the instrument.

Toolbars

The toolbar at the top of the dialog provides basic settings and functions.

- "Live mode" / "logging": If logging is switched on, messages are traced. They are stored in an internal database and can be displayed upon request, using the refresh button (live mode off) or they can be displayed automatically (live mode on).
- "Filter": applies a filter to columns and/or rows when working (live mode off)
- "Refresh": reads the message log from the internal database and displays it

- "Download": stores the SCPI trace log to a *.csv file
- "Clear": deletes all message log entries in the database and on the screen
- "Details": displays details of the selected message, for example an SCPI command in hex format (also possible by double-clicking a message)

Columns

The following columns are available if no column filter is applied:

- "Rec": record number of the message within the message log
- I: number of the subinstrument
- "MT": indicates the type of the message. Possible values and related message contents are:
 - > = incoming command
 - < = outgoing response to a query
 - E = error message, highlighted by red color
 - T = execution time, i.e. time required by the instrument to process the command internally
- "message": indicates the type of the message. Possible values and related message contents are:
 - > = incoming command
 - < = outgoing response to a query
 - E = error message, denoted in red
 - T = execution time, i.e. time required by the instrument to process the command internally

3 Getting Started

This section helps you to get familiar with the R&S SMB. It provides an introduction to the general concept of the instrument with a sample of the possible application fields, and a description of the main blocks in the signal generation flow.

This section also explains the operating concept in general and includes a brief introduction to operation by a step-by-step description of the configuration. The example is intended to provide a quick overview of the settings provided. No additional equipment is required.

3.1 Brief Introduction to the Instrument's Concept

The **operating concept** of the R&S SMB employs the following three ways of instrument control:

- Manual operation
- Remote control
- Remote access

Manual Operation

The R&S SMB can be entirely operated from the front panel. Peripherals such as mouse or keyboard can be connected but are not essential.

The R&S SMB is equipped with an intuitive user interface. The central element of the display is the block diagram that shows the signal flow and processing from the left on the display to most right, i.e. the generated signal can be seen at a glance.

Each block represents a functional unit of the instrument. Thus you always know the position at which a parameter affects the signal flow. The main settings of a block are indicated in the block. The interconnection of employed inputs and outputs is also shown. The user is thus always informed about the connection of inputs and outputs in the signal flow and where they can be configured. A window is opened for each menu where parameters can be set. When the window is opened, an entry is made in the "Winbar" below the display. All open menus are of equal priority (not modal) and can be accessed any time.

The block diagram in the figure below shows a fully equipped instrument.

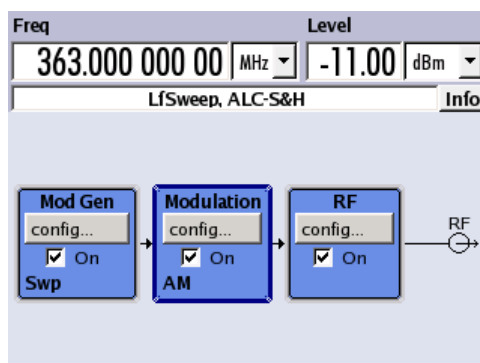

Figure 3-1: Block diagram of a fully equipped R&S SMB

With the rotary knob, you can navigate in the block diagram and the dialogs, and operate the instrument with one hand. The cursor is moved line by line through the block diagram or dialog. Turning the button clockwise advances the cursor. The selected block can be activated or deactivated with the TOGGLE key. Active blocks are highlighted by a colored background.

The instrument comprises a comprehensive info and help system. You can access the context-sensitive help with the HELP (F1) key at any time. The help system indicates the currently selected parameter and offers additional services such as cross references, index and contents. The content of the help system corresponds to the operating manual of the instrument.

Warning and conflict messages caused by incorrect operation as well as further information are displayed in the "Info" line. A complete list of existing conflicts is displayed when the INFO (CTRL+I) key is pressed. Additional information on entries can be requested from the help system. The history function permits display of all messages.

Assistants simplify the completion of tables. After data entry in the assistant, the table is modified only after the "Accept" button has been pressed. Pressing the "Accept" button also stores the assistant data.

For an introduction into the manual operating of the instrument, detailed operating instructions and an overview of menus refer to [Chapter 4, "Manual Operation"](#), on page 64.

For an in-depth description of the dialog boxes and the instrument functions, refer to section [Chapter 5.1, "Overview of Instrument Functions"](#), on page 89.

Remote Control

Remote control is an operation of the instrument by means of remote control commands or programs that automatize repeating settings. The instrument is connected to a computer running the program.

The R&S SMB supports various remote control connections:

- Connecting the instrument to a (LAN) network
- Using the LXI browser interface in a LAN network
- Connecting a PC via the IEC-bus (IEEE 488) interface
- Remote control via the USB interface



Tip: For remote control over LAN or USB, you can use the R&S VISA (Virtual Instrument Software Architecture) library provided for download at the Rohde & Schwarz website <http://www.rohde-schwarz.com/rsvisa>.

This way of operation and the instructions how to set up a connection for remote control are described in the [Chapter 6, "Remote Control Basics"](#), on page 235. The description of the remote control commands is provided in [Chapter 7, "Remote Control Commands"](#), on page 279.

Remote access

Remote access is the operating of the instrument from a remote computer. Both the R&S SMB and the computer are connected in a LAN.

Remote access in contrast to **remote control** does not use remote-control commands but a separate software which is installed on the remote computer. After its start, the software simulates the user interface of the instrument. The instrument can thus be operated from the remote computer as on the unit itself. The individual functions are operated using the mouse and keyboard. Specific instrument functions can be executed using specific key combinations on the keyboard or a front panel key emulation that can be operated with the mouse.

This way of operation and the instructions how to set up a connection for remote access are described in [Chapter 2.7, "Remote Access via an External Controller"](#), on page 37.

3.2 Application Field of the Instrument

The main field of application of the R&S SMB is the generation of sine wave signals with very high spectral purity. These signals are needed e.g. for adjacent channel or phase noise measurements. In addition, the RF signal can be modulated with the internal modulations waveforms sine waves and rectangular signals.

3.3 Description of Individual Diagram Blocks

The signal path of the instrument is configured by installing a frequency option that comprises all required modules.



One of the following options must be installed.

- R&S SMB-B101 (up to 1.1 GHz)
- R&S SMB-B102 (up to 2.2 GHz)
- R&S SMB-B103 (up to 3.2 GHz)
- R&S SMB-B106 (up to 6 GHz)
- R&S SMB-B112 (up to 12,75 GHz)
- R&S SMB-B112L (up to 12,75 GHz without attenuator)
- R&S SMB-B120 (up to 20 GHz)
- R&S SMB-B120L (up to 20 GHz without attenuator)
- R&S SMB-B131 (up to 31,8 GHz)
- R&S SMB-B140/-B140N (up to 40 GHz)
- R&S SMB-B140L (up to 40 GHz without attenuator)

Instruments without step attenuator provide a restricted level range at the RF output. Refer to the data sheet for detailed information.

You can additionally get the following options for microwave instruments:

- up to 20 GHz (R&S SMB-B120/-B120L)
 - high output power option R&S SMB-B31
 - low harmonic filter option R&S SMB-B25
- up to 40 GHz (R&S SMB-B140/-B140L/-B140N)
 - high output power option R&S SMB-B32
 - low harmonic filter option R&S SMB-B26

See data sheet for detailed information.

Up-to-date information is available at R&S SMB homepage on the internet <http://www.rohde-schwarz.com/product/smb100a.html>.



Mod Gen block

The internal modulation sources are configured in this block. Also, the "LF frequency sweep" can be activated here.

An internal LF generator is available as the internal source for the analog modulations AM, FM and PhiM. Available modulation shapes are sine and rectangle.

The internal modulation signals are provided at the LF output at the front of the instrument. The LF output signal and the modulations sources for the analog modulations AM, FM and PhiM can be selected independently from each other.

A pulse generator provides single and double pulse modulation with selectable pulse widths and periods. Additionally, an option is available to generate pulse train signals.

The R&S SMB offers three different sweep types (frequency sweep, level sweep and LF sweep) to be activated alternatively. Each type has 6 modes which differ with respect to the sweep cycle mode (continuous, individual and step-by-step) and triggering mode (automatic, internal and external). In the "Mod Gen" block, the LF sweep is configured. Frequency and level sweep settings are accessed via the "RF" block.

The status display in the block shows whether LF generator and/or a sweep are active. The selected internal LF generator and/or noise source are switched on or off with the TOGGLE ON/OFF key.

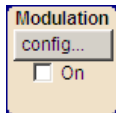

Modulation block

The internal and external analog modulations are configured and activated in this block. The MOD ON/OFF key switches the active modulation(s) on/off.

The internal modulation sources are configured in the "Mod Gen" block. External amplitude, frequency or phase modulation signals can be fed in at the input connector MOD EXT at the front of the instrument. An external pulse signal is fed in via the BNC connector PULSE EXT at the rear of the instrument. AC or DC coupling for external feed is possible.

Modulation signals of up to two sources (internal and external source) can be combined for AM/FM and PhiM modulation.

Available internal and external analog modulation modes are:

- Amplitude modulation (AM)
- Frequency modulation (FM)
- Phase modulation (PhiM)
- Pulse modulation (Pulse)
- Stereo modulation (Stereo)

Note: For modulation modes that can be simultaneously used, refer to the R&S SMB data sheet.

The status display in the block shows the active modulation(s). Use the TOGGLE ON/OFF key to switch the active modulation of the block on or off.



RF block

In this block, the RF parameters and frequency/level sweep settings are set.

The active sweep is displayed in the block. The RF ON/OFF key switches the RF signal on and off. When the signal is switched off, the switch before the RF output symbol is open.

RF settings include:

- Frequency and reference frequency
- Level settings; if required.
- NRP-Z Power Viewer using power sensors
- Frequency and level sweep
- List Mode settings. In this mode, extremely fast frequency and level settings can be made.

The RF 50 OHM output connector at the front of the instrument provides the RF signal. An external trigger/gate signal for sweeps is input via the INST TRIG connector at the rear of the instrument

Note: Frequency and level are set fast with the aid of the FREQ and LEVEL keys. Use the TOGGLE ON/OFF key to switch the RF output on or off.

3.4 Example of Setup

This section provides an example on how to configure the instrument for generating of an amplitude modulated signal.

Generation of an Amplitude-Modulated Signal

To generate a simple AM-modulated signal, proceed as follow:

1. Activate default (preset) state
Press the PRESET key to set a defined instrument state.

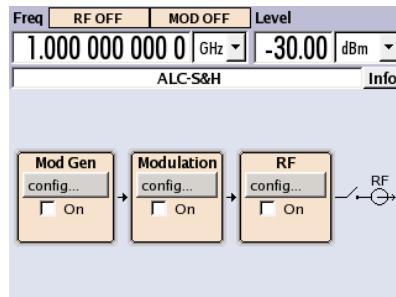

2. Select and activate AM modulation
 - a) Turn the rotary knob and select the "Modulation" block.

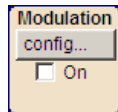

- b) Press the rotary knob to open the dialog where the modulation can be selected.

Note: Different modulation modes are available depending on the options installed.

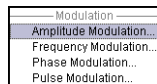

The "Amplitude Mod..." menu is the first menu and is highlighted per default.

- c) Turn the rotary knob and highlight "Amplitude Mod...".
Press the rotary knob to open the "Amplitude Modulation" dialog.

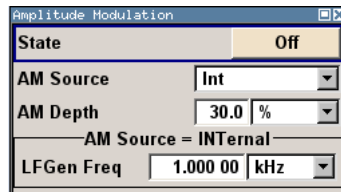

- d) Turn the rotary knob to select parameter "AM Depth", press the rotary knob to allow editing and enter the preferred AM depth with the aid of the numeric keypad and the unit keys.

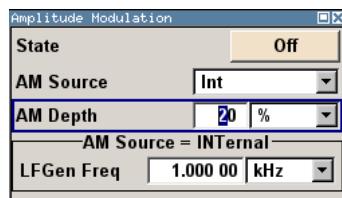

- e) Finally, select "State" and press the rotary knob to switch on the AM modulation.

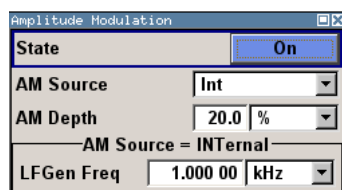

- f) Press the DIAGRAM key to display the complete block diagram.

To indicate the active state, the "Modulation" block is displayed in blue. The "RF" is not yet active, which means that no RF signal is output.

3. Set frequency and level and activate RF signal

- a) Press the FREQ key to activate the editing mode for frequency entry. The "Frequency" entry field in the header section of the display is highlighted.

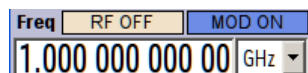

Enter the frequency using the numeric keypad and terminate the entry by pressing a unit key.

- b) Press the LEVEL key and enter the level settings in the same way.

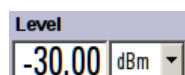

- c) Press the DIAGRAM key to display the complete block diagram.
 d) Turn the rotary knob to select the "RF" block.
 Press the RF ON/OFF key to activate the "RF" block.

The AM modulation signal is now present at the RF output.

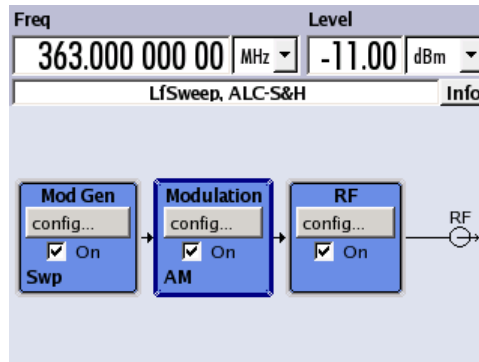

Generation of an RF Frequency Sweep Signal

In the example, an RF frequency sweep is configured. Proceed as follow:

1. Activate default (preset) state
Press the PRESET key to set a defined instrument state.

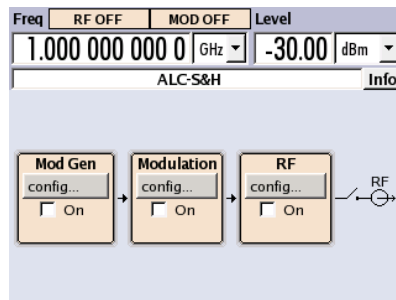

2. Configure and activate RF frequency sweep.
 - a) Turn the rotary knob and select the "RF" block.



- b) Press the rotary knob to open the dialog where the RF frequency sweep can be selected.

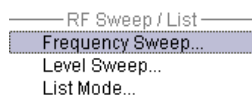

- c) Turn the rotary knob and highlight "RF Frequency Sweep...". Press the rotary knob to open the "RF Frequency Sweep" dialog.

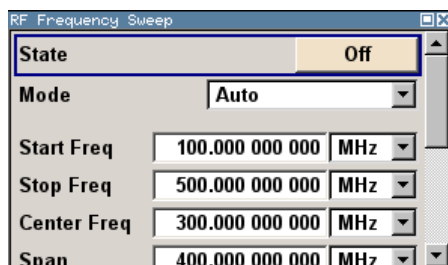

All sweep parameters are default except for the sweep mode. The default settings are not changed.

- d) Turn the rotary knob to select parameter "Mode", press the rotary knob to open the selection list and select "Single".

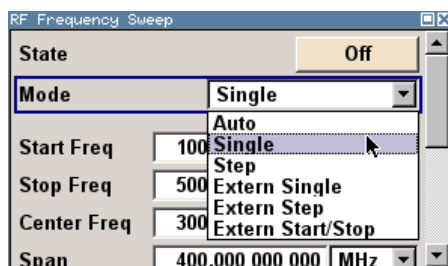

- e) Press the rotary knob to apply the selection. For triggering, the "Execute Single Sweep" and "Reset Sweep" buttons are displayed.
- f) Finally, select "State" and press the rotary knob to switch on the RF frequency sweep.

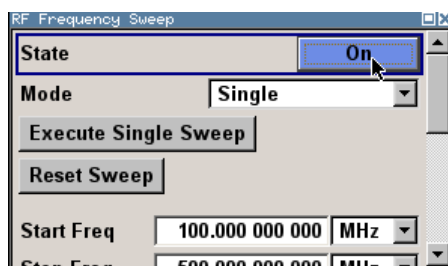

- g) Press the DIAGRAM key to display the complete block diagram. The "RF" is not yet active, which means that no RF signal is output.
3. Activate RF signal.
- a) Turn the rotary knob to select the "RF" block.
 - b) Press the RF ON/OFF key to activate the "RF" signal output.

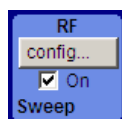

To indicate the active state, the RF block is displayed in blue. An RF signal with the default frequency and level settings is output, i.e. 1 GHz and -30 dBm. The sweep is not yet active, it must be triggered in the sweep dialog.

4. Trigger RF frequency sweep
 - a) Press the WINBAR key to switch to the "RF Frequency Sweep" dialog. Turn the rotary knob to select the "Execute Single Sweep" button.

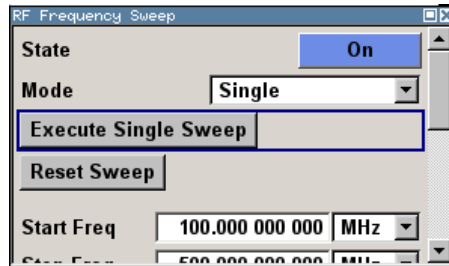

Press the rotary knob to trigger (start) the frequency sweep.

A linear single sweep signal is now present at the RF output, starting at 100 MHz. The sweep is processed in 1 MHz steps with dwell time of 10 ms per step up to the stop frequency of 500 MHz.

The sweep starts at 100 MHz, stops at 500 MHz in 1 MHz steps is output with a dwell time of 10 ms per step.

4 Manual Operation

The R&S SMB can be operated intuitively either via the interactive block diagram or via a menu tree. All menus are in the form of windows that can be operated in the same way. Rotary knob, keys and softkeys, or alternatively a mouse, allow direct and therefore convenient access to entries and settings.

The clear-cut display shows the current signal generator state. Numerous help functions support the user in signal configuration.

This section describes the concept of manual operation of the signal generator. This includes a description of the general structure of a dialog box, working with dialog boxes and the block diagram and the setting of parameters.

For an in-depth description of the dialog boxes and the instrument functions refer to section "Instrument Functions".

4.1 Key Features

The manual operating concept of the R&S SMB enables the user to make settings as intuitively as possible and at the same time gives a permanent overview of characteristics of the generated signal and of the current instrument state. Numerous online help functions support user settings.

Block diagram

The block diagram is the core of the operating concept.

A graphics display shows the current configuration and the signal flow in the form of a block diagram. All graphical elements can be accessed for operation. An element is selected by means of the arrow keys and the associated setting function is called by pressing Enter. Required menus and graphs are displayed on the block diagram which is displayed again in the foreground whenever the DIAGRAM (CTRL+D) key is pressed.

Permanent frequency and level display

The main characteristics of the RF signal, frequency and level, are permanently displayed in the header section of the screen and can be directly set in the display fields after the FREQ (CTRL+F) or LEVEL (CTRL+L) key is pressed. Status messages for the output signal are displayed in addition to frequency and level.

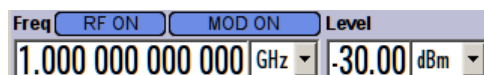

Operation via Graphical User Interface

- **Functional blocks**

Menus are assigned to the specific function blocks in the block diagram. The function blocks represent elements of signal generation. Function blocks displayed with

a blue frame can be directly switched on and off by means of the TOGGLE ON/OFF (CTRL+T) key. The menus of the highlighted function blocks can be called by pressing the ENTER key.

– **Example:**

The "Modulation" block contains all menus required for modulation signal configuration.

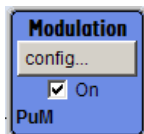

In this block all modulations can be selected.

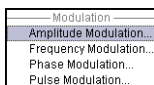

• **Signal flow**

The signal flow between the function blocks and the employed inputs and outputs are also shown.

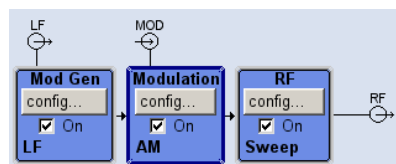

• **Menu tree**

The menu tree can be opened and closed with the MENU (CTRL+M) key. The menu tree is organized in the same way as the directories under Windows. The function blocks correspond to the first directory level, the menus to subdirectories.

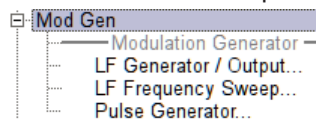

Operation corresponds to the Windows concept

To offer the user a familiar environment, operation is very similar to operation of Windows user interfaces. All menus and tables are made up of known elements, such as selection lists, check boxes and entry fields.

A blue frame indicates that the selected item is active. In the highlighted element, entries can be made.

Rotary knob



Operation is possible via front-panel keys, an external keyboard and the mouse. However, most of the settings can be easily made with the rotary knob:

- Turning the rotary knob shifts the entry focus to the target element.



- Pressing the rotary knob activates the selected entry field. Depending on the parameter, the submenu is called, the numeric value varied, the list entry selected or the check box activated or deactivated.
- If a value is entered, the entry is stored by another click on the rotary knob and the editing mode is exited.

Clear settings with the aid of independent subdialogs

A separate window is opened for each dialog and subdialog. The dialogs can be operated independently of each other, i.e. none of the dialogs requires that settings in other dialogs be completed before it can be closed. This ensures flexible operation at all times.

Keys with assigned simple functions

Most keys on the front panel of the R&S SMB directly perform a simple function.

Since a great number of settings can thus be made by a keystroke, operation is easy. For instance, the CLOSE (ESC) key closes the active menu; with the RF ON/OFF (CTRL+R) key the RF output signal can be switched on or off.

An exception are keys that call a menu such as the MENU (CTRL+M) key which opens the complete menu tree of the instrument, the SETUP (CTRL+E) key which opens the menus for general instrument settings or the FILE (CTRL+S) key which opens the menu for file management.

Help functions for user support

Numerous help functions support the user in signal configuration.

- **Value ranges**

The valid setting range is displayed for each numeric parameter. This requires a short wait after activation of the entry field. The range is then displayed automatically after a few seconds.

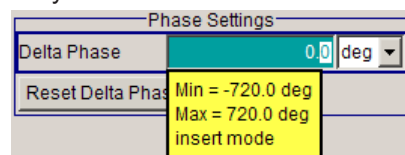

If the entered value is outside the permissible range, the next permissible value is automatically set and a message is output.

- **Context-sensitive help**

Context-sensitive help for each parameter can be called with the HELP or F1 key.

- **Comprehensive online help**

Each help page is part of a comprehensive online help function which can be called by means of an index, a content tree or the "Previous/Next" buttons.

Info line with messages for indication of the current instrument state

A great variety of different messages such as status messages, error messages, warnings or information are displayed in the header field of the screen. With the aid of the INFO (CTRL+I) key, help pages can be called for most of the messages. They provide

background information on the message and indicate operating steps that may be required. All messages are explained in the online help which can be called with the HELP (F1) key.

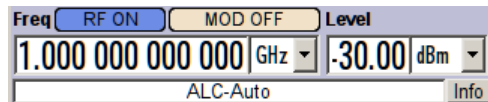

4.2 Display

The display shows the current signal generator state and offers graphical elements for direct operation. It is divided into three sections:

- The frequency and level display with info line indicates the main output signal parameters and reports the current state with status, error and warning messages.
- The block diagram shows the instrument configuration, the signal characteristic as well as the inputs and outputs used and permits interactive operation via graphics elements. Active menus and graphs are displayed on top of the block diagram.
- Winbar with labeled softkeys for menu display.

The block diagram in the figure below shows a fully equipped instrument.

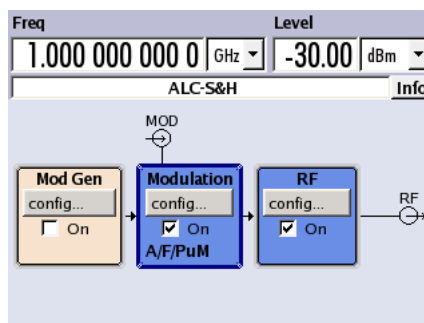

Figure 4-1: Block diagram of a fully equipped R&S SMB

4.2.1 Settings Displayed in the Header Section

Frequency/level settings and a few status messages (see [Chapter 4.2.2, "Status Information and Messages"](#), on page 68) are displayed in the header field of the screen.

The display may vary depending on the instrument's operating mode:

- In the sweep mode, the current frequency or level of the output signal is displayed. The status message "SweepMode" is displayed in the info line.
- In the list mode, neither the current frequency nor level is displayed, the indication is dimmed.
- If user correction is active, the status message "UCorr" is displayed in the info line.



The values displayed in the "Freq" and "Level" fields include a set offset or multiplier factor.

For more See also [Chapter 5.3.2, "RF Frequency"](#), on page 137 and [Chapter 5.3.5.1, "Overview of RF Level"](#), on page 145.

The frequency and level indication can be enlarged so that it covers the complete display of the R&S SMB by using the DIAGR key. This key toggles between block diagram, magnified frequency and level indication and the display of the active dialog. This requires the "Summary Screen Toggle" to be enabled.

See also ["Toggle Summary Screen"](#) on page 108.

4.2.2 Status Information and Messages

The instrument indicates status information and messages in the header section of the screen. The messages differ with respect to their importance (errors, warnings, info) and the time of their appearance (brief and permanent messages), and require different treatment

For additional information refer to the info window (see [Chapter 4.2.3, "Info Window"](#), on page 69).

Refer to [Chapter 9, "Status Information, Error Messages and Troubleshooting"](#), on page 481 for an overview of all status information and messages and corrective actions.

4.2.2.1 Status Information

The status information gives the user an overview of the main operating states and settings of the instrument. The states are indicated for information only and do not necessitate any action by the user.

Status information is displayed between the frequency and level fields, at the left of the info line or in the info line itself.

4.2.2.2 Messages

Messages indicate errors in the instrument. They are displayed in the info line in different colors depending on their importance and display duration. Errors (e.g. no calibration data) are displayed in red, information (e.g. file not found) and warnings in black. Warnings indicate less significant errors (e.g. the instrument operates outside specified data).

4.2.2.3 Volatile messages

Brief messages report automatic settings in the instrument (e.g. switching off of incompatible types of modulation) or on illegal entries that are not accepted by the instrument

(e.g. range violations). They are displayed in the info line on a yellow background. They are displayed on top of status information or permanent messages.

Volatile messages do not normally demand user actions and disappear automatically after a brief period of time. They are stored in the history, however.

These messages can be read from remote using the commands `:SYSTem:ERRor[:NEXT]?` and `:SYSTem:ERRor:ALL?`.

4.2.2.4 Permanent Messages

Permanent messages are displayed if an error occurs that impairs further instrument operation, e.g. a hardware fault. The error signalled by a permanent message must be eliminated before correct instrument operation can be ensured.

The message is displayed until the error is eliminated. It covers the status display in the info line. After error elimination, the message automatically disappears and is also recorded in the history.

These messages can be read from remote using the command `:SYSTem:SERRor?`.

4.2.3 Info Window

A few operating states and the current message are displayed in the info line.

The INFO window with a list of current permanent messages and a detailed description of each message can be opened with the INFO (CTRL+I) key.

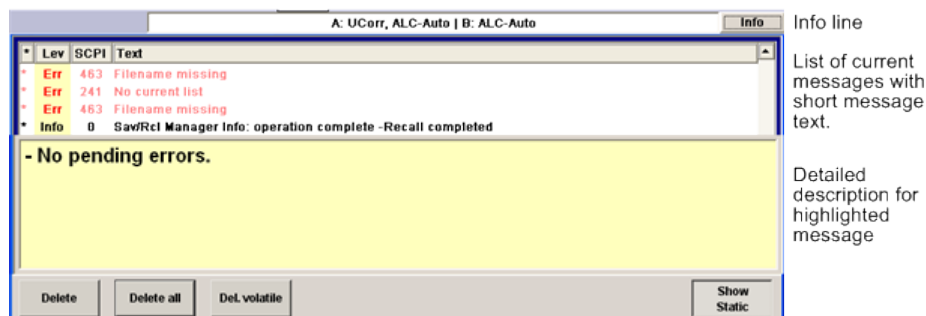

The upper section of the info window contains a list of all current permanent messages in the order of their occurrence, i.e. the most recent message is displayed first. In the lower section of the window, additional information on the highlighted message is displayed. A history of all messages that have occurred since instrument switch-on can be called with the "History" key. The most recent message is displayed first.

The messages are color-coded according to their level. Device-specific messages are red, info and remote control error are black. The level is also indicated in the "Lev" column (Err, Sys or Info). Column "SCPI" indicates the SCPI error code.

With the aid of the softkey buttons, error messages can be cleared and a history of all messages called.

Delete

Clears the highlighted message.

This button is available only if the history of the messages is displayed.

Delete All

Clears all messages.

This button is available only if the history of the messages is displayed.

History

Calls the list of all messages that have occurred since instrument switch-on. The most recent messages are displayed at the top of the list. When the button is pressed again, the list of current messages is displayed.

Remote command:

`:SYSTem:ERRor[:NEXT]?` on page 435 or `:STATus:QUEue[:NEXT]?`
on page 432

Each time a `SYST:ERR?` or `STAT:QUE?` query is sent, the oldest entry in the error queue is returned and at the same time cleared in the list.

4.2.4 Block Diagram

The block diagram shows provided options, signal configuration and the currently selected signal flow of the generator with inputs and outputs used. Signal generation can be completely operated from the block diagram. The highlighted function block can be directly switched on and off with the TOGGLE ON/OFF (CTRL+T) key. Pressing the Enter opens the associated setting menu.

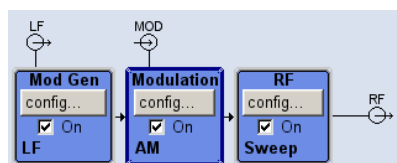
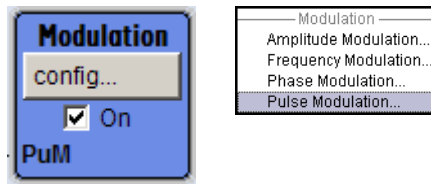

Figure 4-2: Block diagram of the R&S SMB

4.2.4.1 Function Blocks in the Block Diagram

Each block represents a function of signal generation. The function is indicated in the headline of the block. In the check box, the respective function can be quickly activated/ deactivated with the TOGGLE ON/OFF (CTRL+T) key. After activation, the block is displayed in blue. Status information is displayed below the check box. It is different for the different blocks.

Pressing the rotary knob (front panel) or the "Config..." button (mouse) opens the associated setting menu.

Example: Modulation block

In this block, the modulation signals are set. The status information of the "Modulation" block indicates the selected modulation.

4.2.4.2 Signal Flow and Input/Output Symbols in the Block Diagram

The input/output symbols in the block diagram show the currently used inputs and outputs of the signal generator. Unused inputs and outputs are not shown. The lines indicate the signal flow.

Symbols and labels refer to the corresponding inputs and outputs on the front and rear panel of the signal generator. The direction - input or output - is indicated by an arrow.

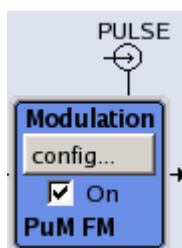
Example:

The symbols indicate the input for the external pulse signal on the instrument rear panel.

4.2.5 Structure of the Dialogs

The parameters are set in the menus. Menus are accessed either via the function blocks in the diagram or by means of the MENU (CTRL+M) key. The menus are displayed on top of the block diagram.

The WINBAR key toggles between the active menus. The REARR key toggles between the enlarged and normal sized menus.

Working with menus and dialog boxes is described in [Chapter 4.3, "Accessing Dialogs"](#), on page 72; the setting of parameters in [Chapter 4.4, "Setting Parameters"](#), on page 73.

The menus are in Windows format. The menus differ in details depending on their function but they consist of the same main elements. Each menu consists of a menu header and one or more menu areas with various fields for setting parameters.

The header line contains the name of the menu and the buttons for minimizing and closing the menu. To operate the buttons, use the mouse or the front key CLOSE (ESC).

Several fields of associated but separately set parameters are organized in menu areas. A menu area is framed and labelled with the function common to all parameters.

Example: Pulse Generator

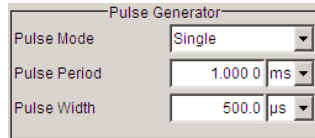

Each of the setting fields is assigned a parameter name. The kind of setting varies depending on the parameter to be set. Some settings can only be made in a specific configuration. If setting is not permitted with the specific configuration selected, the respective item is disabled and displayed in gray and the entry or selection field cannot be accessed.

4.3 Accessing Dialogs

The MENU (CTRL+M) key opens the complete menu tree. Selecting a functional block and pressing the ENTER key opens the menu associated with this block.

An alternatively way to access a dialog is to use the CLOSE (ESC), DIAGRAM (CTRL+D) and REARR (CTRL+A) keys on the front panel.

For a quick access to the dialogs, use one of the following alternative methods.

Displaying the block diagram or a dialog in the foreground

- ▶ Press the DIAGRAM (CTRL+D) key to move the cursor to the block diagram.
All active menus are minimized.

Enlarging the indication of the header section

- ▶ Press the DIAGRAM key twice to enlarge the indication of the header section.
Tip: Use the REARR key to toggle between the enlarged and normal sized dialogs.

Accessing the menu tree

- ▶ Press the MENU (CTRL+M) key to open the complete menu tree.

Calling the File or Setup dialog

- ▶ Use the FILE (CTRL+S) or SETUP (CTRL+E) keys to open the respective dialog.

Closing an active menu

- ▶ Press the CLOSE key to close an active menu.
Tip: If the cursor is at the highest menu level, you can also use the ESC key to close the active menu.

Accessing the header area

- ▶ Press the **FREQ** (CTRL+F) and **LEVEL** (CTRL+L) keys to activate the "Frequency" or "Level" entry fields in the header area.



Keyboard Shortcuts

Keyboard shortcuts (e.g. "Ctrl + D" for the displaying the block diagram in the foreground) provide direct access to all utility dialogs of the instrument (see [Chapter 4.8, "Legend of Front-Panel Controls"](#), on page 86).

4.4 Setting Parameters

The R&S SMB offers several and sometimes alternative possibilities for setting parameters. Operation is possible from the front panel, with the aid of a mouse and/or from a PC keyboard.



The examples within this description focus on the operation from the front panel.



For more information, refer to:

- [Chapter 4.8, "Legend of Front-Panel Controls"](#), on page 86 for an overview of key functions and a cross-reference between the front panel keys and the keyboard shortcuts
- section "Instrument Functions" for a detailed description of key functions.

Most of the parameters are set in the different menus. The R&S SMB provides alternative ways for accessing the dialogs. Turn the rotary knob and navigate to the corresponding block in the block diagram and press the knob to open the dialog or perform a mouse click on the "Config..." button.

An exception are the "Setup" and "File" dialogs. In the "Setup" dialog, general settings are made which are not directly concerned with signal generation, e.g. setting of the GPIB-bus address. In the "File" dialog, files and lists are managed.

These menus can only be called with the **SETUP** (CTRL+E) and **FILE** (CTRL+S) keys.

Frequency and level are directly set in the header area of the display using the **FREQ** and **LEVEL** keys.

Specific settings can also be made directly in the block diagram, e.g. activating a function block by means of the **TOGGLE ON/OFF** (CTRL+T) key or switching the RF output on and off with the aid of the **RF ON/OFF** (CTRL+R) key. Changes affecting the signal flow are immediately visible in the graphics display.

This section provides an information about the parameter handling that comprises of the following main steps:

- [Chapter 4.4.1, "Working with the Cursor"](#), on page 74

- [Chapter 4.4.2, "Selecting a Control Element"](#), on page 74
- [Chapter 4.4.3, "Switching Parameters On/Off"](#), on page 75
- [Chapter 4.4.4, "Entering a Value"](#), on page 75
- [Chapter 4.4.5, "Working with Units "](#), on page 77
- [Chapter 4.4.6, "Selecting a Value from a List"](#), on page 77
- [Chapter 4.4.7, "Terminating Entries with Confirmation"](#), on page 78
- [Chapter 4.4.8, "Restoring the Previous Value"](#), on page 78

4.4.1 Working with the Cursor

After the instrument is switched on, the cursor is always on the first function block of the diagram (default setting).

Moving the cursor on the display

- ▶ To move the cursor, use one of the following alternative methods:
 - a) Use the rotary knob or the arrow keys.
 - b) Use the WINBAR key to toggle between the active dialogs.
 - c) Use the ESC key.

Tip: Be aware that the function of the ESC key depends on the current cursor position.

The function of this key depends on the current cursor position.

- Calls the next higher selection level.
- Closes the open window without accepting new entries; the old value or parameter is retained.
- In dialog boxes that contain a "Cancel" button it activates that button.
- Closes all kinds of dialog boxes, if the edit mode is not active.
- Quits the edit mode, if the edit mode is active.
- Switches between different entry fields of a menu.
- Shifts the entry cursor from the header display to the previously active menu, or to the previously highlighted block in the block diagram if no menu is active.

Moving the cursor to the heading area

- ▶ Press the **FREQ (CTRL+F)** or **LEVEL (CTRL+L)** key to move the cursor to the header area.

4.4.2 Selecting a Control Element

Control elements are always selected in the same way no matter whether a function block in the diagram, a menu in the menu tree, a parameter in the menu or an entry in a list or table is concerned.

- ▶ To activate an element, put the cursor on it.



An active element is highlighted by a blue frame.

4.4.3 Switching Parameters On/Off

A parameter can be activated and deactivated using a button or a check box.

1. Select the parameter.
2. To change the state of a parameter, use the "Enter" function of the different control media:
 - Press the rotary knob
 - Press ENTER
 - Press the TOGGLE ON OFF (CTRL+T) key.

Colour and label of a button change, the check box is ticked or the tick is removed.

4.4.4 Entering a Value

Numeric and alphanumeric values can be edited in the entry fields. In the editing mode, cursors of different colour are used. A blue cursor indicates the overwrite mode, a green cursor the insert mode.

Numeric and alphanumeric values can either be newly entered or the existing value can be changed. Incorrect entries are cleared with the BACKSPACE key.

Entering a new numerical value

1. Select the parameter.
2. Press a numeric key to activate the editing mode.

The previous value is cleared and the new value can be entered.

Editing a value in the insert mode (default setting)

1. Press the rotary knob (= Enter) to activate the editing mode.
If the cursor is placed at the right of the total value, the insert mode is always active.
2. Set the cursor to the left of the number to be changed using the LEFT/RIGHT arrow keys.
The cursor is displayed in green.
3. Click on a numeric key to insert a new value.



Editing a value in the overwrite mode

1. Activate the editing mode.
2. Set the cursor on the numeric digit to be changed using the LEFT/RIGHT arrow keys.

The cursor is displayed in blue and the number to be replaced is highlighted.

3. Click on a numeric key to overwrite the highlighted value.



Varying a value

1. Activate the editing mode.
2. Set the cursor to the left of the number to be changed using the LEFT/RIGHT arrow keys.

The value at the cursor position is varied.

3. To vary the selected value, use the UP/DOWN arrow key or turn the rotary knob.
The value is increased or decreased.

Entering a new alphanumerical value

1. Select the parameter.
2. Press an alphanumeric key to start the editing mode.

The new value is entered.

Editing an alphanumerical value

An existing value, e.g. a file name, can be changed in the insert mode (see example) or in the overwrite mode.

1. Select the parameter and activate the editing mode.
2. Set the cursor to the left of the alphanumerical value using the LEFT/RIGHT arrow keys.

Tip: If hexadecimal values are to be entered, the numeric front-panel keys are automatically changed to hexadecimal values.

3. Click on an alphanumeric key to insert a new alphanumerical value.

Terminating the entry of a numeric value

To terminate the entry of a numeric value:

1. Press the rotary knob (= Enter).
2. Press a UNIT key on the front panel.
3. Select a "Unit" in the selection field next to the parameter value.

4.4.5 Working with Units

The unit of a parameter is displayed next to the value. When the parameter is edited, the unit is selected either from the list or by means of the front-panel keys. When the entry is completed, the unit can be changed. In this case the value remains unchanged but is automatically adapted to the new unit.



While operating the instrument by means of a mouse, assign the unit to the selected parameter before entering its value.

Assigning a unit

To assign a unit to a value, use one of the following alternatives:

1. Press a UNIT key on the front panel.



2. Select a "Unit" in the selection field next to the parameter value.
Press the ENTER key.

The unit displayed in the entry field next to the value is assigned.

Changing a unit

To subsequently change a unit, i.e. after the entry has been terminated and when the editing mode is not active, use one of the following alternatives:

1. Press a UNIT key on the front panel.
2. Select "Unit" in the selection field next to the parameter value.

The value remains unchanged but the display is automatically adapted to the new unit, i.e. the value is recalculated to suit the new unit.



The new unit is indicated in the value field of the menu.

4.4.6 Selecting a Value from a List

Selection lists provide a list of predefined values for the selected parameter.

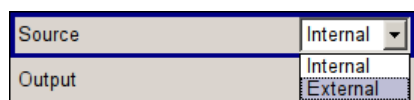

To select a item from a list, proceed as follow:

1. Press ENTER key to open the list.

2. Use one of the following alternatives to navigate through the list:
 - a) Turn the rotary knob or use the UP/DOWN arrow keys.
The selected item is highlighted.
 - b) Press TOGGLE ON/OFF key several times until the preferred entry is displayed in the selection field.
3. To confirm the selection, press the ENTER key.

4.4.7 Terminating Entries with Confirmation

The instrument behaves different by the termination of entries depending on the parameter type and the way this parameter is set.

Confirming settings

- ▶ To confirm the settings, press the rotary knob or one of the UNIT keys (see also [Chapter 4.4.5, "Working with Units "](#), on page 77) .

Note: Variations by means of the rotary knob are immediately set.

Confirming multiple values

In some cases, like for instance when editing data in a user correction table, it is useful first to enter few values and to confirm them together. Such settings require additional confirmation. Not yet confirmed settings are displayed on a yellow background as an indication that the currently displayed values do not represent the target signal.

- ▶ To confirm these settings, select the "Save" or "Accept" button, respectively.

Confirming parameters with On/Off state

Most of the instrument functions with enabled and disabled states are calculated and effective only after this functions have been enabled. However, there are functions like the frequency variation of the reference oscillator for instance, that are immediately set after confirmation.

- ▶ To confirm a parameter with On/Off state, enable the parameter.

4.4.8 Restoring the Previous Value

Parameter variations with the rotary knob are immediately set and therefore not reversible.

Normally, values cannot be restored in the case of mouse control because no explicit confirmation is required in this case and entries are automatically confirmed when the entry or selection field is exited.

Restoring values

In the case of front-panel control or operation from the keyboard, previous values can be restored as long as the new value is not confirmed, i.e. the entry is not completed.

- ▶ To restore the values, press the ESC key.

Restoring values that require confirmation

All settings that are not confirmed with the "Accept" button but require this additional confirmation can be restored.

1. Press the ESC key.

A confirmation query is displayed.

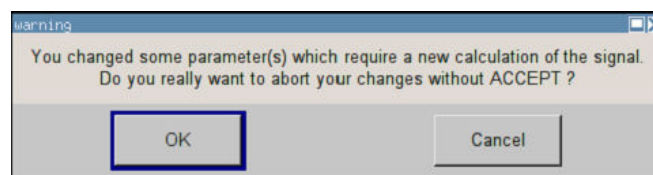

2. Confirm with "OK" to abort the changes.

Select "Cancel" to return to the dialog. The previous selected settings are displayed.

Restoring values after an extended calculation has been started

Calculation and setting might require different period of time. Many settings are made without noticeable calculation times; such operations are indicated by a "BUSY" message displayed in the status field of the header section.

A window with a progress indicates that the instrument performs an extended calculation that requires longer calculation time. The termination of such a calculation restores the previous values.

- ▶ Press the ABORT button to terminate the calculation.

All previous values are restored.

4.5 Editors

The R&S SMB provides user-friendly editors for defining lists. Lists containing frequency and level value pairs are used for the list mode and the user-defined level correction.

The lists are saved to files and may thus have any length. The file name of the lists and the directory to which the files are saved are user-selectable. The file prefix is different for each list type and is permanently assigned by the system.

For information about file handling and overview of the automatically assigned file prefixes, refer to [Chapter 4.7, "File Management"](#), on page 82.

4.5.1 Working with List Editor

The "User Correction" and "List Mode" dialogs provide a list editor for defining the frequency/level value pairs.

Editing list mode data lists

1. To access a list editor and open an existing data list for editing, use the cursor keys to select the associated button "Edit User Correction Data..." or "Edit List Mode Data..." (if available) in the individual menu.

The selected list is displayed and the cursor marks the first row of the "Frequency/Hz" column.

	Frequency/Hz	Power/dBm
1	100 000.000	-140.00
2	100 010.000	-140.00
3	100 020.000	-140.00
4	100 030.000	-140.00
5	100 040.000	-140.00
6	100 050.000	-140.00
7	100 060.000	-140.00
8	100 070.000	-140.00
9	100 080.000	-140.00

Goto Edit Save

If no list has been selected, a blank list of only one row is displayed.

2. Press the LEFT/RIGHT arrow keys to change between the columns. Use the UP/DOWN arrow keys to mark a row.
3. Use the numeric keys to enter the value for the value pairs in the "Frequency/Hz" and "Power/dBm" table columns. A blank row is inserted at the end of the list. Terminate the entry by pressing a UNIT key.
4. To select a row, select the "GoTo" button and press the ENTER key. Use the numeric keys to enter the row index in the entry field and press the ENTER key to confirm the entry. The cursor moves to the selected row.
5. To insert a new row in the table, select the row above which the new row is to be inserted and select "Insert Row(s)".

A row is inserted above the currently marked row.

If no row has been selected, a row is inserted at the beginning of the list.

6. Use the "Save" function to save the edited list under its current name. Enter the file name in the "File Select" dialog and select the directory (see [Chapter 4.7.1, "File Select Dialog"](#), on page 84).

Only complete value pairs are taken into consideration; rows containing an entry in only one column are ignored.

Creating a new list mode data list

A new list can be created under a new name either by generating a blank file in the "File Select" menu (see section [Chapter 4.7, "File Management"](#), on page 82) or by changing an existing list which will then be saved under a new name.

1. To create an empty data list, select "RF > List Mode > List Mode Data... > New List" or respectively "RF > User Correction > User Cor. Data... > New User Correction Data" and enter the file name of the new data list.
2. To open the data list for editing, select the associated button "Edit User Correction Data..." or "Edit List Mode Data..." in the individual menu. Edit the list and save it under a new name.

4.6 How to Use the Help System

The R&S SMB is equipped with a context-sensitive help function. A help page is available for each parameter and can be called any time during instrument operation.

Calling context-sensitive and general help

- ▶ To display the general help dialog box, press the HELP (F1) key.

The help dialog is displayed. A topic containing information about the current menu or the currently opened dialog box and its function is displayed.

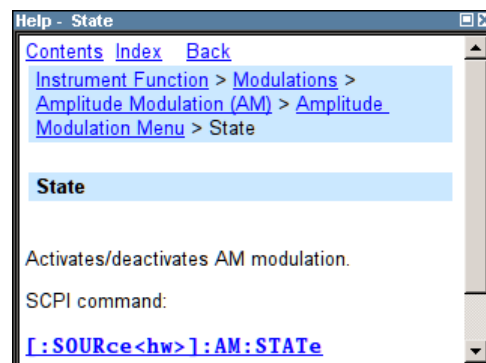

On top, the help dialog box contains a navigation bar with:

- "Contents" - accesses a table of help contents
- "Index" - switches to an index table
- "Back" / "Previous" / "Next" for navigation to further help topics

Navigating in the table of contents

1. To navigate within the table of contents entries, use the UP/DOWN keys. Entries that contain further entries are marked with a plus sign.
2. To display a help topic, press the "ENTER" key. The corresponding help topic is displayed.

Navigating in the help topics

1. To scroll through a page, use the UP/DOWN arrow keys.
2. To follow a cross-reference, select the link text.
3. To return to the previous page, select "Back".
This function scrolls back all steps that you have performed before.
4. Use the "Scroll Right" or "Scroll Left" buttons to shift the indicated area of the navigation window to the left or right.

Using the Index

1. Select "Index".
2. Enter the first characters of the topic you are interested in. The entries starting with these characters are displayed.
3. Press the ENTER key to change the focus.
4. Use the UP/DOWN keys to navigate and select the suitable keyword.
5. Press the ENTER key to display the help topic.
The corresponding help topic is displayed.

Closing the help window

- ▶ Press the HELP (F1) key.

4.7 File Management

The R&S SMB uses files to save all instrument data, i.e. system and user data.

The user data includes saved instrument settings and lists and the user correction.

The files are stored in the internal memory of the instrument or on a USB memory stick. The `/var` directory can be used to save user-defined data; any subdirectory structure can be created on `/var`. Some default subdirectories are predefined, but can be changed at any time.

The `/opt` directory is a protected system drive and therefore unaccessible system directory. The files on this directory contain data that must not be changed. Therefore, this drive should not be accessed, since reconstruction of the system partition will lead to data loss. To prevent inadvertent deletion or overwriting of system files, this drive is not specified in the file menus.

Files can be exchanged either via a memory stick or a connected network. A memory stick is connected to the USB interface and is assigned the `var/usb/` drive. In the case of a connected network, all network drives that can be accessed are available. The files are accessed in a "Save/Recall" dialog in the individual menus.

The files are differentiated according to their extensions; each type of file is assigned a specific file content. The extension is usually of no consequence to the user since

access to the files occurs in the individual menu where only the relevant type of file is available. See [Chapter 4.7.2.1, "Extensions for User Files"](#), on page 85 for an overview of the supported file extensions.

The user data can be roughly divided into the following data types:

- **Settings**
Instrument settings can be saved and loaded. In case of saving, the current setting is saved to the specified file.
- **Lists**
Lists, e.g. user correction lists, can be loaded. They can be generated either externally or internally. For internal generation, a new list must be created in the "File Select" dialog which will then be edited in the list editor of the individual menu.



For more information, refer to:

- [Chapter 4.8, "Legend of Front-Panel Controls"](#), on page 86 for an overview of key functions and a cross-reference between the front panel keys and the keyboard shortcuts
- to section "Instrument Functions" for a detailed description of key functions.

Accessing files with user data

1. To access an editable user data file, select the "Save/Recall" or "File Manger" function in the individual dialog.

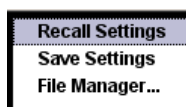

2. To access a loadable data file, select the "Select/New" or "File Manager" function in the individual dialog.

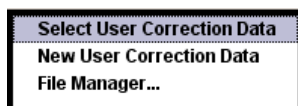

3. To access the "File Manager" function, press the SETUP (CTRL+E) key and select "Save/Recall > File Manager".

A "File Select" window for loading, saving or creating a file or the "File Manager" dialog for managing all files is displayed.



Saving and loading of all instrument settings

All instrument settings are saved and loaded in the "File" menu.

To access the "File" menu, press the FILE (CTRL+S) key.

For more information, see [Chapter 5.2.8, "Storing and Loading Instrument Data - File Key"](#), on page 126.

4.7.1 File Select Dialog

The "Save/Recall" dialog displays the available drives and directories. In the upper part, "Recent Data Sets", the files last used are listed.

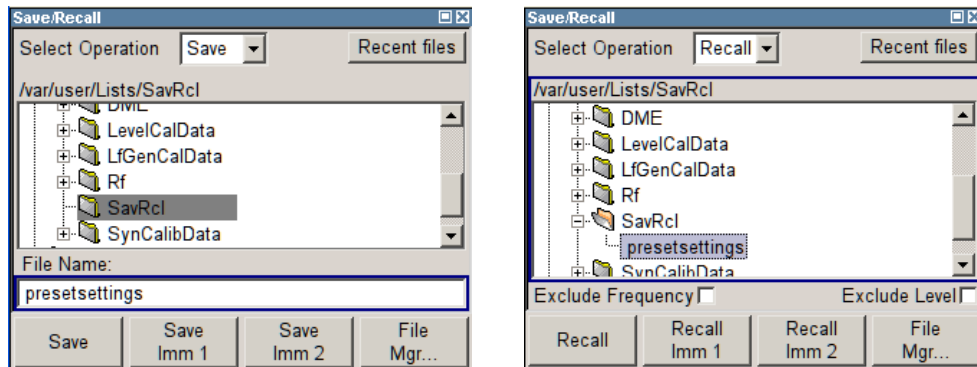

The available drives and directories and the files of the selected directory are displayed. The currently selected path is displayed above the window. Only the relevant files without file extensions are displayed. If the area is opened several times, the path last selected is displayed. When a file is saved or created, its name is user-selectable; the extension is assigned automatically and cannot be entered. The file is saved to the selected path.

In addition to the files saved by the user, some menus also offer files containing predefined contents. These files are saved to a specific directory on system drive; for this reason, this directory cannot be chosen from the "File Select" menu.

Working with the File Select dialog

1. Access the "File Select" dialog (see ["Accessing files with user data"](#) on page 83).
2. Navigate in the "File Select" dialog.
3. Load an existing file.
In the "Recall Settings" dialog, mark a file and press the "Select" button.
4. Save a file.
In the "Save Settings" dialog, enter file name in the "File Name:" field.
Select the directory to which the file is to be saved and then select the "Save" button.
5. Create a new file.
To create a new file, use the "Save Settings" functionality, i.e. specify file name and directory and save the file.

The created file is empty; it must be filled with the necessary values in the individual editor.

4.7.2 File Manager

The "File Manager" allows general file management such as copying, shifting, renaming and deleting files as well as generating new directories.

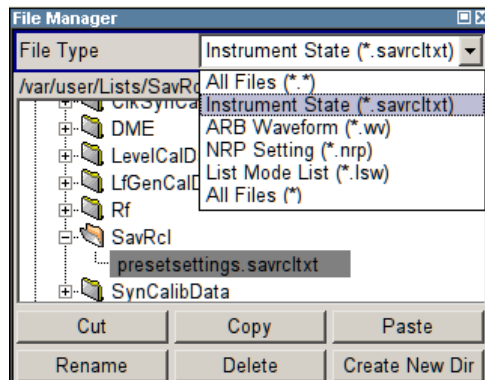

Use the "File Type" to select a file type from the list. This can be used to process either all files (all files (*) selection) or a specific selection of files. See [Chapter 4.7.2.1, "Extensions for User Files"](#), on page 85 for an overview of the supported file extensions. The available drives and directories and the files of the selected directory are displayed. The currently selected path is displayed above the windows. If the area is opened several times, the path last selected is displayed. Unlike the "File Select" window, the "File Manager" displays the full file names including extensions.

Working with the File Manager dialog

1. Accessing the "File Manager" dialog (see ["Accessing files with user data"](#) on page 83).
2. Navigating in the "File Manager" dialog.
Operation is very similar to the operation of a standard Windows explorer.
3. Moving, duplicating, deleting or renaming files
To move a file, select the file and press the "Cut" button. Mark the directory to which the file is to be moved and select the "Paste" button. If the target directory already contains a file with the same name, a confirmation query is displayed to confirm overwriting of this file.
Perform the similar steps and cut/copy/rename/delete the file.
Tip: The operation corresponds to the Windows concept.
4. Creating a new directory
Mark drive or directory level where the new directory is to be created, select the "Create New Directory" button and enter the name of the new directory in the entry window that opens. Confirm with ENTER.

4.7.2.1 Extensions for User Files

The following table lists all available file extensions for user files. The currently available files on the instrument depend on the installed options.

Table 4-1: List of the automatically assigned file extensions in the instrument

Function	List type	Contents	File suffix
Instrument State	Settings	Instrument settings	*.savrc1txt
"User Correction"	List	User-defined level correction values	*.uco
		Export Data	*.txt or *.csv
"List Mode"	List	User-defined frequency/level value pairs	*.lsw
		Export Data	*.txt or *.csv
"Pulse Train List"		User-defined offtime/ontime/repetition values	*.pulstrn
SMZ Settings	Settings	Data (firmware) of a connected SMZ frequency multiplier	*.efmfirm
NRP Settings	Settings	NRP Settings	*.nrp

4.8 Legend of Front-Panel Controls

The following table lists all key functions available on the front panel. Key combinations used on the PC keyboard to trigger key functions on the instrument front panel are also described. Keyboard labels are described in alphabetical order.

In addition, a front panel key emulation and an on-screen keyboard can be used for manual operation by mouse only.

Table 4-2: Cross-reference between the front panel keys and keyboard shortcuts

Front-panel key	Key of PC keyboard	Function
Turning the rotary knob	Tab key (towards the right) Shift + Tab (towards the left)	Sets the cursor with the rotary knob.
Pressing the rotary knob	Enter	Pressing the rotary knob confirms an entry; it has the same function as the ENTER key.
Arrow keys	Arrow keys	Moves the cursor.
ENTER / *1 / dB(m)	Enter ALT + F12	Terminates an entry. Confirms entries in the base unit and values without a unit. Selects dBm for the RF level and dB for level offset and level step width.
. / *...#	. / *...#	Enters a period/decimal point. Enters a special character.
- / A<->a	- / (shift+) a—z	Enters the sign. Switches between upper-case and lower-case letters.
0-9 / a...z	CTRL+ 0-9 / a...z CTRL	Enters the number/letter.

Front-panel key	Key of PC keyboard	Function
BACKSPACE	Backspace	Clears the last entry (number, sign or decimal point)
ESC / CLOSE	ESC / CTRL + G	Selects the next higher menu/selection level. When the editing mode is exited with ESC, the previous value is restored. Closes an active menu.
DIAGR	CTRL+ D	Sets the cursor on the block diagram and hides all menus.
FILE	CTRL + S	Activates the menu for storing instrument settings.
FREQ	CTRL+ F	Activates the frequency entry.
G/n / dBuV	ALT + F9	Selects the unit Giga/Nano, dBuV for the RF level and dBu for the LF level.
HELP	F1	Opens/closes context-sensitive help.
INFO	CTRL + I	Opens/closes the info window
k/m / mV	ALT + F11	Selects the units kilo/milli and mV for RF levels.
LEVEL	CTRL + L	Activates the level entry.
LOCAL	CTRL + Q	Switches the instrument from remote control to manual control.
M/u / uV	ALT + F10	Selects the units Mega/Micro and uV for RF levels.
MOD ON/OFF	CTRL + O	Switches modulation on/off. "MOD OFF" is indicated in the status line.
TOGGLE	CTRL + T	Switches a block or parameter on/off. Toggles between the different possibilities of setting a selection parameter.
PRESET	CTRL + P	Restores a defined basic instrument setup.
RF ON/OFF	CTRL + R	Switches the RF output signal on/off. "RF OFF" is indicated in the status line.
SETUP	CTRL + E	Opens the setup menu for general instrument settings.
WINBAR	CTRL + W	Toggles between the active menus.

4.8.1 Front Panel Key Emulation

The R&S SMB provides a front panel key emulation to enable execution of the front panel key functions by mouse e.g. for remote access. The emulation is called by a right mouse click. The front panel key functions are executed by a mouse click on the associated button.

Freq	Diagram
Level	Menu
File	Rearr.
RF On/Off	WinBar
Mod On/Off	Help
Preset	
Local	
Setup	
Hardcopy	
Info	

5 Instrument Function

5.1 Overview of Instrument Functions

This chapter explains the functions of the R&S SMB and the options available in the setting menus. The associated SCPI command is specified for each parameter (where applicable).

The description starts with the general instrument settings which do not directly affect signal generation. The majority of these settings can be accessed by means of front-panel softkey menus and not by means of function block menus.

The signal generation functions are then described, beginning with the functions which affect the RF signal ("RF" block) and the analog modulations ("Mod" block). The configuration of the modulation generators (LF generators and pulse generator) and of the LF sweep is offered in the "Mod Gen" block. The clock synthesis signal is set in the "Clock Synthesis" block.

The general instrument settings include various functions, such as:

- Setting a defined basic setup using the PRESET key
see [Chapter 5.2.2, "Default Instrument Settings - Preset Key"](#), on page 91
- Switching from remote control to manual control using the LOCAL key
see [Chapter 5.2.4, "Switching to Manual Control - Local Key"](#), on page 121
- Configuring the generator and its interfaces in the "Setup" dialog - e.g. setting the GPIB address, starting an adjustment, querying instrument data
see [Chapter 5.2.3, "General Configuration of Instrument - Setup Key"](#), on page 91
- Calling up the online help using the HELP key
see [Chapter 5.2.7, "Help System - Help Key"](#), on page 125
- Querying messages using the INFO key
see [Chapter 5.2.6, "Messages - Info Key"](#), on page 125
- Loading and storing complete instrument settings in the "File" menu
see [Chapter 5.2.8, "Storing and Loading Instrument Data - File Key"](#), on page 126

The RF signal and the reference oscillator are configured in the "RF" function block:

- CW mode
see [Chapter 5.3.1, "Overview of RF Signal"](#), on page 135
- List mode
see [Chapter 5.3.7.4, "List Mode"](#), on page 187
- Frequency and Level Sweep mode
see [Chapter 5.3.7.1, "Overview"](#), on page 174
- Reference Oscillator
see [Chapter 5.3.4, "Reference Oscillator"](#), on page 141
- RF Level
see [Chapter 5.3.5.1, "Overview of RF Level"](#), on page 145

- RF Level Sweep
see [Chapter 5.3.7.3, "RF Level Sweep"](#), on page 182
- ALC
see [Chapter 5.3.5.4, "Automatic Level Control - ALC"](#), on page 151
- Power Sensors
see [Chapter 5.3.6.1, "NRP-Z Power Viewer"](#), on page 166
- User Correction
see [Chapter 5.3.5.6, "User Correction"](#), on page 158

The analog and external digital modulations are activated in the "Modulation" function block:

- Amplitude Modulation
see [Chapter 5.4.2, "Amplitude Modulation \(AM\)"](#), on page 198
- Frequency Modulation
see [Chapter 5.4.3, "Frequency Modulation \(FM\)"](#), on page 202
- Phase Modulation
see [Chapter 5.4.4, "Phase Modulation \(PhiM\)"](#), on page 206
- Pulse Modulation
see [Chapter 5.4.5, "Pulse Modulation \(PM\)"](#), on page 209
- Stereo Modulation
see [Chapter 5.4.6, "Stereo Modulation"](#), on page 211

The internal LF generators, the LF frequency sweep and the pulse generator are configured in the "Mod Gen" function block:

- LF Frequency Sweep
see [Chapter 5.5.3, "LF Frequency Sweep"](#), on page 220
- LF output
see [Chapter 5.5.2, "LF Output"](#), on page 218

5.2 General Instrument Settings

5.2.1 Overview of General Instrument Settings

This section describes the settings which do not directly affect signal generation. Most of these settings can only be accessed by means of menus which are opened using keys or key combinations on the external keyboard or keys on the front panel key emulation.

The general instrument settings therefore affect various functions, such as storing instrument settings using the FILE key or setting the GPIB address in the menu of the SETUP key. The order in which the descriptions are given corresponds to the layout of the keys on the front panel of the R&S SMB (from top left to bottom right).

5.2.2 Default Instrument Settings - Preset Key

The PRESET key performs a defined instrument setup. All parameters and switching states are preset (also those of inactive operating modes). The default instrument settings provide a reproducible initial basis for further settings.

However, functions concerning the integration of the instrument in a measurement setup are not changed, for example the GPIB address or reference oscillator settings.

When the instrument is switched on, it is not the preset state that is active, but rather the instrument state that was set before the instrument was switched on.

User-defined instrument states can be accessed and stored in the "File" menu.



Resetting the instrument to the factory state is possible with the [Factory Preset](#) function.

Preset

Presets all parameters and switching states.

The following list gives an overview of the presets for the most important generator settings. The other presets can be found in the preset tables of the individual menus and the information accompanying the remote commands.

- "RF frequency" = 1 GHz
- "RF level" RF output switched off
- "Level" = 30 dBm for instruments including an attenuator
"Level" = -5 dBm for instruments with no attenuator
- "Offsets" = 0
- "Modulations State" = Off
- Uninterrupted level settings are switched off
"Level Attenuator Mode" = AUTO
- Internal level control "Level ALC" = AUTO
- User correction "Level Ucor" = OFF
- "LF output State" = Off
- "Sweep State" = Off

Settings that are not affected by the PRESET key

- Reference frequency settings ("Ref Oscillator" menu)
- Power on settings ("Level/EMF" menu)
- Network settings ("Setup" menu)
- GPIB address ("Setup" menu)
- *IDN? Identification and emulation ("Setup" menu)
- Password and settings protected by passwords ("Setup" menu)
- Start/Stop Display Update ("Setup" menu)
- Display and keyboard settings ("Setup" menu)

Remote command:

*RST on page 282

5.2.3 General Configuration of Instrument - Setup Key

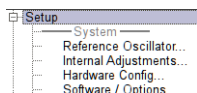

The "Setup" menu provides access to basic instrument settings, regardless of the currently set operating mode or measurement. It contains information on the instrument's equipment, and comprises all settings for the general configuration of the instrument and its interfaces.

To access the "Setup" menu, press the SETUP key.

The "Setup" menu is divided into functional sections as follows:

- "System": covers general instrument parameters.
- "Test": used to perform function tests.
- "Environment": used to configure the controller interfaces.
- "Remote": used to configure the remote control interfaces.
- "Protection": used to set the protection level for service functions and security settings.
- "Settings": used to save or recall instrument settings or to preset the instrument to factory settings.

Most submenus of this key can be accessed only via the SETUP key or the menu tree (MENU key), with the following exceptions:

- The "Reference Oscillator" dialog can also be accessed in the "RF" block and is therefore described in the section on this block (see [Chapter 5.3.4, "Reference Oscillator"](#), on page 141).
- The "Save/Recall" dialog can also be accessed with the FILE key and is therefore described in the section on this key (see [Chapter 5.2.8, "Storing and Loading Instrument Data - File Key"](#), on page 126).

5.2.3.1 Internal Adjustments

The R&S SMB is extremely accurate due to the integrated adjustment procedures, which you can execute directly on the instrument.



Self-calibration routines that do require additional (external) measurement equipment are either described in the Service Manual of the instrument, or they require to be performed by a Rohde & Schwarz service center.

NOTICE

Risk of invalid adjustment

In order to achieve correct adjustment of the instrument, make sure that the instrument is warm before performing adjustments. The warm-up time is 30 minutes.

When to perform adjustments?

It is recommended to perform internal adjustments prior to any application that requires a maximum of level and frequency accuracy, especially when a long period of time has passed or if the ambient temperature of the instrument significantly differs from the one of the last adjustment.

Additional Information to the Adjustments

During adjustments, a progress indicator shows the status of the process. If any error occurs, the process aborts and an error message appears in the info line.

The extent of the adjustments depends on the installed options.

NOTICE

Risk of damage to the DUT

High power at the RF output may destroy a connected DUT (**D**evice **U**nder **T**est).

During level adjustments instruments without step attenuator, that means with frequency options R&S SMB-BxxxL, temporarily apply high power at the RF output. This may damage the DUT. Therefore, it is required that the RF connector is terminated during the adjustments.

Disconnect the DUT and replace it by a 50 Ohm terminating resistor.

- ▶ To access the settings for internal adjustments, press the SETUP key and select "System > Internal Adjustments".

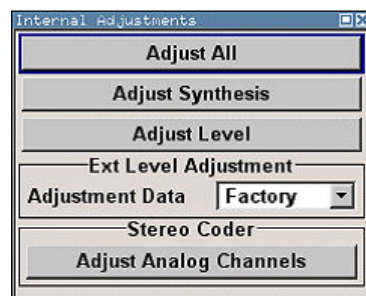

In this dialog you can perform internal calibration routines.

The remote commands required to define these settings are described in [Chapter 7.4, "CALibration Subsystem"](#), on page 286.

Adjust All

Performs all available internal calibration routines of the instrument.

Adjustment may take some time. Especially in instruments with frequencies above 6 GHz, it may last up to 15 minutes.

Remote command:

`:CALibration<hw>:ALL[:MEASure]?` on page 286

Adjust Synthesis

Performs all adjustments which affect the frequency.

Remote command:

`:CALibration<hw>:FREQuency[:MEASure]?` on page 287

Adjust Level

Performs all adjustments which affect the level. The acquired correction values improve the settling time and the signal quality.

Remote command:

`:CALibration<hw>:LEVel[:MEASure]?` on page 287

Adjust Stereo Coder

Performs all adjustments which affect the analog channels of the stereo coder. For the adjustment of the S/P DIF see Service Manual, chapter 2, "Adjustment".

Remote command:

`[:SOURce]:CALibration:STEReo:ANALog[:MEAS]?` on page 288

5.2.3.2 Hardware Config

In the "Hardware Config" dialog, the installed assemblies together with their variants and revision states can be displayed for servicing purposes.

To open the "Hardware Config" dialog, select "System" and press the SETUP or MENU key.

Counter		
Operation Time / h		6
Power On Count		0

Common Assembly		
Assembly	Part Number	Revision
SMB100A	1406.6000k02	--
Basis Board	1406.6600.00	00.00
COM-FPGA		00.00.00

RF Assembly		
Assembly	Part Number	Revision
RF Board	1406.7220.06	01.01
MOD-FPGA		20.20.00

Baseband Assembly		
Assembly	Part Number	Revision
Stereo Coder	1407.3240.00	00.00

Section "Counter" in the upper part of the menu shows the "Operation Time" (in hours) and the number of power-on ("Power On Counter").

The second part of the menu is a table that lists the installed assemblies. It is divided into the sections:

- "Common Assembly"
- "RF Assembly"
- "Baseband Assembly"

Operation Time / h

Displays the operation time in hours.

Remote command:

`:DIAGnostic:INFO:OTIME?` on page 289

Power On Count

Displays the number of power-on.

Remote command:

:DIAGnostic:INFO:POCount? on page 290

Assembly

The tables list the installed assemblies.

"Assembly" Assembly name

"Part Number" Part Number of assembly

"Revision" Revision state of assembly

Remote command:

:DIAGnostic<hw>:BGInfo? on page 288

5.2.3.3 Software / Options

The "Software/Options" dialog shows the firmware version of the instrument software and all installed hardware and software options.



Software options purchased at a later stage can be activated with a keycode. The activation code is supplied with the software option.

How to install options is described in chapter 4 "Software Update / Installing Options" of the service manual.

The installation of hardware options purchased at a later stage is also described in the service manual. Most hardware options need to be installed at an authorized Rohde&Schwarz service shop.

To access the "Software/Options" dialog, select "System" and press the SETUP or MENU key.

The menu is divided into the following sections:

- "Firmware"
- "Hardware Options"
- "Software Options"

Package	More...
SMB100A FW	02.05.19 beta (Release..
R&S COMPASS	2.1.59.0 (Release)

Hardware Options	
Option	More...
SMB-B106	9 kHz to 6 GHz

Software Options (Internal)	
Option	More...
SMB-K22	Pulse Modulator (Desi..
SMB-K23	Pulse Generator (Desi..

Firmware

The firmware section of the menu shows the firmware version and the version of the software platform.

Note: Your instrument is delivered with the latest firmware version available. Firmware updates and the "Release Notes" describing the improvements and modifications are provided on the Internet at the download site of the Rohde & Schwarz signal generator home page. This home page always offers the latest information on your signal generator, e.g. also on changes of the firmware update procedure.

Remote command:

n.a.

Hardware Options / Software Options

The tables in the sections "Hardware" and "Software" list the installed hardware and software options.

"Option" Short name of option

"Designation" Name of option

Remote command:

*OPT? on page 281

*IDN? on page 281

Loaded Modules

Section "Loaded Modules" is provided for service purposes. It lists all loaded software modules with their versions and offers a short description of each module.

Remote command:

n.a.

5.2.3.4 Manage License Keys

This dialog is the central dialog for managing licenses, like enabling newly purchased and/or newly registered options or performing the required instrument related steps during the process of unregistration of licenses.

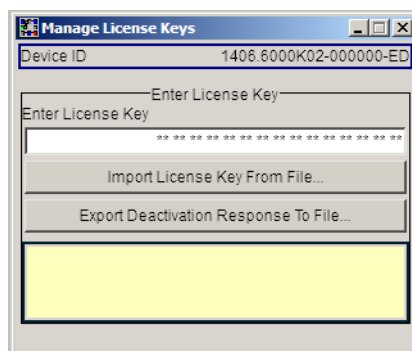

An option is ready to operate after it is enabled by means of a license key code supplied with the option. The license key is delivered as a file or on paper. Unregistered licenses must be registered for a particular instrument prior to the corresponding option can be enabled for operation.



License Registration

If your purchased license is delivered unregistered, you must register it before you can activate the option.

For detailed information about the license registration, refer to the installation instructions provided with the option (Supplement A) and the documentation of the online tool "Manage Licenses" (<https://extranet.rohde-schwarz.com/service>).



Only if the R&S SMB is equipped with an older firmware version, a firmware update prior to enabling the software option may be required. The information on the valid firmware versions for the purchased software option is provided together with the option.

The firmware update is described in the service manual, chapter 4.

Device ID

Displays the instrument specific identification number. The device ID is a unique string with the following structure:

```
<stock number>-<serial number>-<checksum>
```

Enter License Key

Type here the license key provided with the option.

For license keys delivered as a file, use [Import License Key from File...](#)

Import License Key from File...

Opens a dialog for selecting the file with the license key.

Export Deactivation Response to File...

Exports the generated deactivation response key to a file and opens a file management dialog to save the file. This key is required during the unregistration process.

Status Information

Displays status information.

5.2.3.5 NRP-Z Info/Update

The "NRP-Z Info/Update..." dialog covers information on connected power sensors, like serial number, revision state and features of the particular sensor. You can directly perform an update of the sensor firmware.

- To access this dialog, select "Setup > System > NRP-Z Info/Update...".

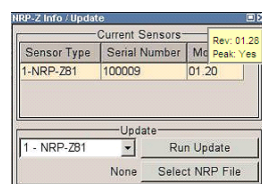

The "NRP-Z Info / Update" dialog indicates the connected R&S NRP-Z Power Sensors with specific information and contains the functions to update the firmware of a connected sensor.

The remote commands required to remotely configure the power sensor settings are described in [Chapter 7.12, "SENSe, READ and INITiate Subsystems"](#), on page 315.

How to update an R&S NRP sensor

To perform an R&S NRP sensor update proceed as follows:

1. Open the R&S website <http://www.rohde-schwarz.com> in section "Power Meters & Voltmeters > R&S NRP-Z Sensors".
2. Select the respective sensor, e.g. R&S NRP-Z81.
3. Select "Downloads > Firmware" and the offered firmware suitable for your sensor.
4. Transfer and save the firmware on the instruments, for example in the `/var/` directory.
5. Connect the sensor to the R&S SMB and select "Setup > System > NRP-Z Info Update" to open the dialog.
6. Select the sensor in the left sensor selection field.
7. Select the update file with "Select NRP File".
8. Start the update procedure with "Run Update".

The update starts and a bar indicates the progress.

How to restart an interrupted update of an R&S NRP sensor

An accidental removal of the sensor during the update process interrupts the update.

If no other sensor is connected to the instrument, proceed as follows to restart the update process:

1. Do not reconnect the sensor but keep it ready to be connected.
2. In the "Setup > System > NRP-Z Info Update" dialog, select "Rescue" in the left sensor selection field
3. Activate "Run Update".
4. Confirm query in message box
5. Connect sensor within 4 seconds

The update starts, a bar informs about the progress.

Current Sensors

Shows the sensors that are connected to the generator with information on serial number, the revision state and some features.

Tip: Click on a sensor to get quick information about the firmware version and whether this sensor measures the peak of the signal.

Remote command:

`SENSe<ch>[:POWER]:TYPE?` on page 324

`SENSe<ch>[:POWER]:SVERsion?` on page 323

`SENSe<ch>[:POWER]:SNUMber?` on page 322

Update

Section "Update" provides access to the file system in order to select a file for an R&S NRP sensor update (Button "Select NRP File"), the selected file is indicated to the left of the button. On the left side, the sensor to be updated is selected.

Button "Run Update" starts the update.

Note: If the update is interrupted for example by accidental removal of the sensor during the process, the button "Rescue" appears. Thus, you can restart the update process.

Prerequisite is that no other sensor is connected to the instrument.

Refer to "[How to update an R&S NRP sensor](#)" on page 98 and "[How to restart an interrupted update of an R&S NRP sensor](#)" on page 98 for detailed instructions.

Remote command:

n.a.

5.2.3.6 SMZ Info Update

The "SMZ Info/Update" dialog covers information on a connected frequency multiplier, like type, serial number revision state, frequency range and firmware version. You can directly perform an update of the multiplier firmware.

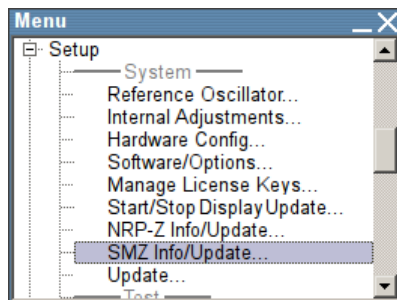

To access the "SMZ Info/Update" dialog, perform one of the following

- On the front panel, press the SETUP key and select "SMZ > SMZ Info Update".
- In the block diagram, select "RF Block > Configure > SMZ Info Update"

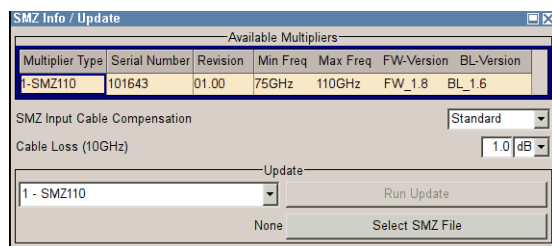



- Where you can find the description...
Since this section is relevant when an R&S SMZxxx frequency multiplier is connected, you can find a detailed description in the user manual of the frequency multiplier. It is included in the online help of the R&S SMB, but can also be found in pdf format on the CD, or on the R&S website <http://www.rohde-schwarz.com/product/SMZ.html>.

5.2.3.7 Display Update

The "Start/Stop Display Update" dialog provides the possibility to switch off update of the displayed parameters in order to increase speed for certain settings.

The indicated values are not updated and may therefore differ from the intern, used values.

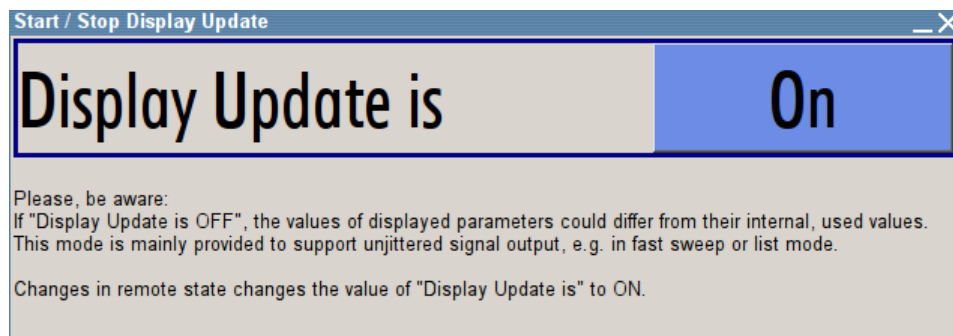

Display Update is On/Off

Switches on/off update of the displayed parameters.

Switching off the update of the displayed parameters increases the speed for certain settings.

Note: For optimum sweep performance with short dwell times and for fast settling times, it is recommended to switch off the display update .

Remote command:

:SYSTem:DISPlay:UPDate on page 445

5.2.3.8 Selftest

A selftest is provided for service purposes.

Access:

1. Select "Setup > Test > Selftest"
2. Select "Start Selftest".

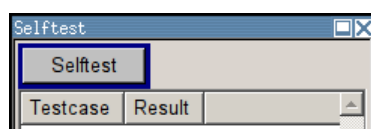



The following tests are only available via remote control:

- `:TEST<hw>:DIRect` on page 449

Start Selftest

Performs a selftest on all installed hardware options.

When completed, the R&S SMB displays a list of all performed test cases and the test results (passed or failed).

Note: While the self test is in progress, the actual signal level at the RF output is -50 dBm. This value is not indicated in the status bar.

Remote command:

`:TEST<hw>:ALL:START` on page 448

`:TEST<hw>:ALL:RESult?` on page 448

5.2.3.9 Check Front Panel

With the functions provided in this dialog you can verify the functionality of the control keys of the R&S SMB.

In case of malfunctions, contact your Rohde & Schwarz Customer Support Center for technical support, see <http://www.customersupport@rohde-schwarz.com>.



Accessing the online help in the check front panel dialog or exiting via ESC

During the test, the actual functions of all keys are disabled, including the HELP and the ESC keys.

Check Front Panel Settings

- To access this dialog, Press the "setup" key and select "Setup > Test > Check Front Panel".

Preset		Roll l.		Roll r.	
Help		Roll click			ESC
		Up			Diagr
		Left		Right	Mod
		Down			RF
Local	Freq				
Setup	Level	7	8	9	G/n
File	Toggle	4	5	6	M/μ
Info	Back	1	2	3	k/m
Winbar		0	.	+/-	^1

Reflecting the front panel, the "Check Front Panel" dialog contains all functions to test the operating elements of the instrument.

Performing the Front Panel Tests

To perform the front panel test, you operate the keys at the front panel, and check the response of the instrument in the "Check Front Panel" dialog. To perform this test properly, it is essential that you check each key of the front panel. The test is only completed, when you have verified all keys.

During the test, the actual functions of the keys are disabled.

Proceed as follows:

1. Press the SETUP key.
2. Select "Test > Check Front Panel"
The "Check Front Panel" dialog opens.
3. Press a key on the front panel.
Check if the corresponding key in the "Check Front Panel" dialog turns green.
4. Press the same key a second time.
Check that the key in the dialog turns red.
Note: Pressing the same key again has no further effect, with the exception of the ESC key, see [Press the ESC key a third time](#).
5. Continue with the next key on the front panel and repeat [step 3](#) to [step 5](#) until all keys are tested.

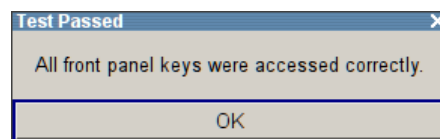

The test is completed, when each key is verified successfully, confirmed by a "Test passed" message.

Select "OK" to exit the test.

- ▶ Press the ESC key a third time.
Exits the "Check Front Panel" dialog, even if you have not yet checked all the keys.

Expected responses:

- Pressing a key once (green), pressing twice (red)
- Pressing the ESC key a third time exits the dialog.

If you detect a malfunction, for example, you press the front panel key the first time, and the color of the button in the dialog turns red (instead of green), the front panel key may be stuck. In this case, contact the Rohde & Schwarz Customer Support Center for technical support, see <http://www.customersupport@rohde-schwarz.com>.

5.2.3.10 Shutting Down and Rebooting the Instrument

The POWER ON/STANDBY front panel key switches the instrument from the standby to the ready state or vice versa. In remote operation form a remote computer or in

manual control, the R&S SMB provides you with another possibility to shut the instrument down or to reboot the system.

- ▶ To access the required settings, select "Setup > Environment > Shut Down".

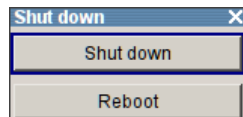

Remote control commands:

- `:SYSTem:SHUTdown` on page 445
- `:SYSTem:REBoot` on page 444
- see also `:SYSTem:REStart` on page 444

5.2.3.11 Date and Time

The R&S SMB uses an internal real time clock to determine the date and time. It adjusts the time and date to the timezone of your location automatically, by providing a selection list of continents and cities.

The instrument records the time whenever you create or modify files on your instrument or you use timed licences.

To access the required settings:

- ▶ Select "Setup > Environment > Date/Time" via the SETUP or MENU key.

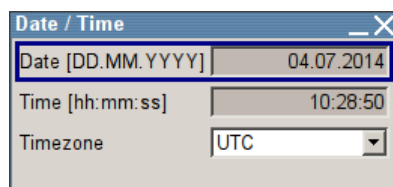

The "Date / Time" dialog contains the time and data settings of the operating system.



The parameters "Date" and "Time" are protected to prevent accidental changes. To enable editing, unlock protection level 1, see [Chapter 5.2.3.17, "Protection"](#), on page 113.

Date

Displays the date set in the operating system in the format [dd.mm.yyyy].

Remote command:

`:SYSTem:DATE` on page 445

Time

Displays the time set in the operating system in the format [hh.mm.ss].

The time setting corresponds to the selected [Time Zone](#).

Remote command:

:SYSTem:TIME on page 446

Time Zone

Selects the time zone.

You can select the time zone according to the major cities on the respective continents.

Note: By typing the first letter, you can quickly navigate through the lists to find the desired destination.

Remote command:

:SYSTem:TIME:ZONE on page 446

:SYSTem:TIME:ZONE:CATalog? on page 446

5.2.3.12 Network Settings

The "Network Settings" dialog shows the parameters relevant for identifying the instrument in a network. The R&S SMB is equipped with a network interface and can be connected to an Ethernet LAN (local area network).

How to connect the signal generator to the network is described in [Chapter 2.6.1, "Connecting the Instrument to the Network"](#), on page 35.

NOTICE

Risk of network errors!

Connection errors can affect the entire network.

If your network does not support DHCP, or if you choose to disable dynamic TCP/IP configuration, you must assign valid address information before connecting the instrument to the LAN.

Contact your network administrator to obtain a valid IP address.

-
- ▶ To access this dialog, press the SETUP or MENU key and select "Environment > Network Settings".

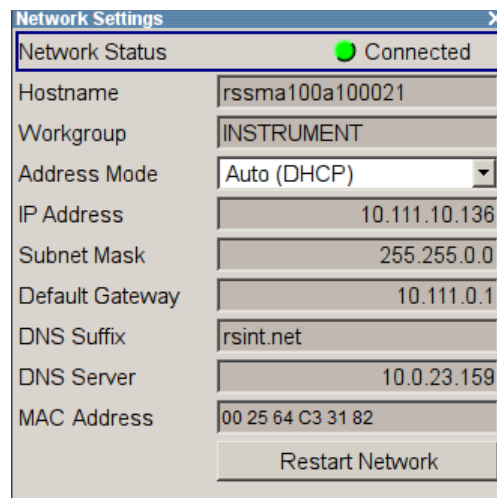

In the "Network Settings" dialog, you can configure the settings of the general network environment and specific identification parameters of the instrument in the network.

The remote commands required to remotely configure the network are described in [Chapter 7.15, "SYSTem Subsystem"](#), on page 433.

Network Status

Indicates that the instrument is connected to the network.

Remote command:

`:SYSTem:COMMunicate:NETWork:STATus?` on page 440

Hostname

Displays the host name.

Each instrument is delivered with an assigned host name, a logical name which can be used instead of the IP address. With the default network settings, the IP address is allocated by the DHCP server. This address may change each time the instrument is reconnected. Unlike the IP address, the host name does not change.

Note: Since the host name of the instrument is a protected parameter, you must first unlock protection level 1 to enable the entry (see [Chapter 5.2.3.17, "Protection"](#), on page 113).

It is recommended that you neither change the default network settings nor the host name in order to avoid problems with the network connection.

However, if you change the host name be sure to use an unique name.

Remote command:

`:SYSTem:COMMunicate:NETWork[:COMMON]:HOSTname` on page 438

Workgroup

Sets the individual windows workgroup name of the R&S SMB. This parameter is required in case the instrument is integrated in a windows network.

Note: Since the workgroup name of the instrument is a protected parameter, you must first unlock protection level 1 to enable the entry (see [Chapter 5.2.3.17, "Protection"](#), on page 113).

Remote command:

`:SYSTEM:COMMunicate:NETWork[:COMMON]:WORKgroup` on page 438

Address Mode

Selects the mode for assigning the IP address.

"Auto (DHCP)" Assigns the IP address automatically, provided the network supports DHCP (**D**ynamic **H**ost **C**onfiguration **P**rotocol). The network used must support automatic assignment of the IP address via DHCP or APIPA (Zeroconf) in order to use this function.

"Static" Enables you to assign the IP address manually.

Remote command:

`:SYSTEM:COMMunicate:NETWork:IPAddress:MODE` on page 439

IP Address

Displays the IP address.

By default, the R&S SMB is configured to use dynamic TCP/IP configuration and to obtain the whole address information automatically.

If the network does not support DHCP or the attempt does not succeed, the instrument tries to obtain the IP address via Zeroconf (APIPA) protocol. IP addresses assigned via Zeroconf start with the number blocks 169.254.*.*.

Note: An IP address that is assigned via the Zeroconf protocol while the network requires an IP address assigned via the DHCP server may cause network connection failures.

See [Chapter 9.5, "Resolving Network Connection Failures"](#), on page 487.

To assign the IP address manually, select [Address Mode "Static"](#).

Remote command:

`:SYSTEM:COMMunicate:NETWork:IPAddress` on page 439

Subnet Mask

Displays the bit group of the subnet in the host identifier.

To assign the subnet mask manually, select [Address Mode "Static"](#).

Remote command:

`:SYSTEM:COMMunicate:NETWork[:IPAddress]:SUBNet:MASK` on page 440

Default Gateway

Displays the gateway address.

To assign the gateway address manually, select [Address Mode "Static"](#).

This address identifies the router on the same network as the instrument that is used to forward traffic to destinations beyond the local network.

Remote command:

`:SYSTEM:COMMunicate:NETWork[:IPAddress]:GATeway` on page 439

DNS Suffix

Displays the primary DNS (**D**omain **N**ame **S**ystem) suffix, that means the DNS name without the host name part.

The DNS system uses the suffix for registration and name resolution to uniquely identify the instrument in the entire network.

To assign the DNS suffix manually, select **Address Mode** "Static".

Remote command:

`:SYSTEM:COMMunicate:NETWork[:COMMON]:DOMain` on page 438

DNS Server

Determines the preferred server for name resolution. The DNS server contains the underlying numerical values that are required for name resolution of the host name as part of the IP address.

To select the DNS server manually, select **Address Mode** "Static".

Remote command:

`:SYSTEM:COMMunicate:NETWork[:IPAddress]:DNS` on page 439

MAC Address

Indicates the MAC (**M**edia **A**ccess **C**ontrol) address, a unique identifier of the network adapter in the R&S SMB.

Remote command:

`:SYSTEM:COMMunicate:NETWork:MACaddress` on page 440

Restart Network

Terminates the network connection to the instrument and subsequently re-establishes it.

Used this function to resolve network problems.

Note: Only the connection of the instrument to the network restarts, the network itself is not affected.

Remote command:

`:SYSTEM:COMMunicate:NETWork:REStart` on page 440

5.2.3.13 Display/Keyboard Settings

In the "Display/Keyboard Settings" dialog the power-save mode and external keyboard settings are made. It is opened using the SETUP or MENU key under "Environment".

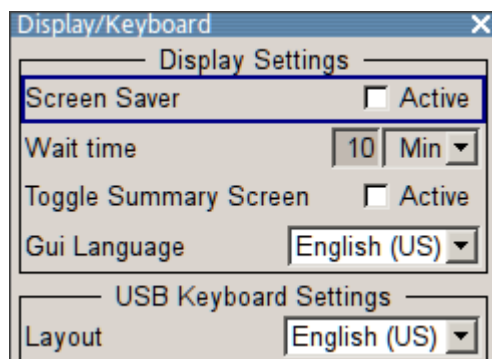

Screen Saver Active

Activates/deactivates the screen-save mode of the display.

If activated, the display including backlight is completely switched off after the elapse of the "Wait Time" when no entries via front panel, external mouse or external keyboard are made.

This mode is recommended for preserving the display especially if the instrument is exclusively operated via remote control.

Remote command:

`:DISPlay:PSAVe[:STATe]` on page 292

Wait Time

Enters the idle time that must elapse before the display lamp is shut off when no entries are made.

Remote command:

`:DISPlay:PSAVe:HOLDoff` on page 292

Toggle Summary Screen

Activates/deactivates the magnified frequency and level indication. If activated, the frequency and level indication covers the complete display.

Remote command:

n.a.

GUI Language

Selects the language of the graphical user interface.

Remote command:

n.a.

Layout (USB Keyboard Settings)

Selects the keyboard layout for the selected keyboard language.

The assignment of some keys depends on the selected layout and language.

Remote command:

`:KBOard:LAYout` on page 302

`:KBOard:LANGUage` on page 302

5.2.3.14 Remote Channel Settings

The "Remote Channel Settings" dialog provides access to the settings for remote control. The dialog is opened using the SETUP or MENU key under "Remote".

- ▶ To access this dialog, press the SETUP or MENU key and select "Remote > GPIB,...".

The "Remote Channel Settings" dialog contains the GPIB address and displays the VISA resource strings provided for remote control via the various interfaces.

GPIB channel address

Sets the address of the GPIB channel the instrument is connected to.

Remote command:

`:SYSTEM:COMMunicate:GPIB[:SELF]:ADDRESS` on page 438

RS232 using USB adapter

Remote control via a serial interface is possible via a USB. The controller and the instrument must be connected with the external USB/serial-adapter R&S TS1-USB (see recommended extras in the data sheet) and a serial crossover (null modem) cable. A USB connection requires the VISA library to be installed on the controller. VISA will detect and configure the R&S SMB automatically when the USB connection is established.

In addition, you can also use a Bluetooth connection for remote control via the serial interface. The settings are effective for both interfaces (see also [Chapter 5.2.3.18, "Security"](#), on page 114).

Baud Rate ← RS232 using USB adapter

Sets the baudrate for the serial remote control interface.

Remote command:

`:SYSTEM:COMMunicate:SERial:BAUD` on page 442

Parity ← RS232 using USB adapter

Sets the parity for the serial remote control interface.

Remote command:

`:SYSTEM:COMMunicate:SERial:PARity` on page 442

Stop Bits ← RS232 using USB adapter

Sets the number of stop bits for the serial remote control interface.

Remote command:

`:SYSTem:COMMunicate:SERial:SBITs` on page 443

Visa Resource Strings

Displays the visa resource strings, used for remote control of the instrument. Each interface requires an individual unique address, to identify the instrument for remote control.

Remote command:

`:SYSTem:COMMunicate:HISLip:RESource?` on page 441

`:SYSTem:COMMunicate:NETWork:RESource?` on page 441

`:SYSTem:COMMunicate:SOCKet:RESource?` on page 443

`:SYSTem:COMMunicate:GPIB:RESource?` on page 441

`:SYSTem:COMMunicate:USB:RESource?` on page 441

`:SYSTem:COMMunicate:SERial:RESource?` on page 442

Goto Local

Switches the instrument to operate in local control mode.

Switching from remote to local control mode can be also done with one of the following actions:

- manually with the LOCAL key on the front panel
- with the interface command `>L` via the remote control interface
- with the key combination CTRL + Q.

Remote command:

`>L`

5.2.3.15 Instrument Emulations

It is also possible to remotely control the R&S SMB via the command set of another signal generator, as for example of an HP generator. With this function you can, for example, replace a signal generator with an R&S SMB in an automated test setup, without adjusting the command scripts used.

You find all the remote control command sets supported by the R&S SMB in a selection list. For more information on this topic, an application note describes in detail how to use this feature. See the product site of the R&S SMB.

The selected instrument also defines the identification string that is retrieved with query `*IDN?`. In addition to the preset values, you can enter a user-defined identification string, for example to provide individual identification for each generator, like 'MY_R&S SMB' (see [Mode](#) and [IDN String](#)).

As any other parameter, you can additionally change the remote control command set to be emulated via the [Language](#) command. However, once you have switched to an emulation, the R&S SMB specific command set is disabled, that means this command is no longer effective. To return, you need to know the corresponding remote control command of the simulated instrument. If you emulate an HP generator for example, the HP command `EX` returns to the SCPI command set.

- ▶ To access this dialog, press the SETUP or MENU key and select "Remote > Instrument Emulations".

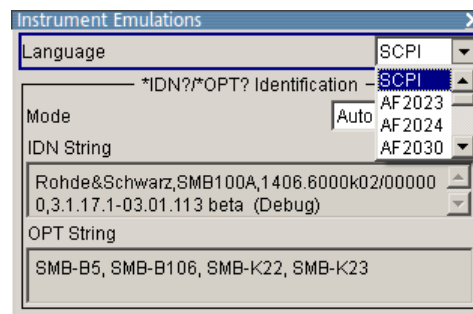

The "Instrument Emulations" dialog enables you to emulate a remote control command set of several other signal generators.

The remote commands required to remotely configure the emulation settings are described in [Chapter 7.15, "SYSTEM Subsystem"](#), on page 433.

Language

Selects the instrument whose remote command set is emulated by the R&S SMB.

Remote command:

:[SYSTEM:LANGUage](#) on page 443

Mode

Selects the way the instrument identification is performed.

"Automatic" Sets the "IDN String" and the "OPT String" automatically for the instrument selected with the parameter [Language](#).

"User Defined" Enables you to define the "IDN String" and the "OPT String" for the instrument selected with the parameter [Language](#).

Remote command:

:[SYSTEM:IDENTification](#) on page 443

Set to default

Enables you to reset the *IDN and *OPT strings in user defined mode, see "[Mode](#)" on page 111 .

The default strings vary depending on the selected emulation mode ([Language](#))

IDN String

Indicates the identification string of the instrument when queried with the common command *IDN?.

To assign a user defined identification string, select [Mode](#) "User defined".

Remote command:

*[IDN?](#) on page 281

OPT String

Indicates the option string of the instrument as queried with the common command *OPT?.

If a "User defined"(see [Mode](#)) [IDN String](#) is selected, you can create a user defined option string in addition to the automatically created one.

Remote command:

*OPT? on page 281

5.2.3.16 LXI Status

The "LXI - LAN eXtensions for Instruments - Status..." dialog displays the settings and status of the LAN and allows to reset the LAN connection.

For more information on LXI, see [Chapter 2.8, "LXI Configuration"](#), on page 45.

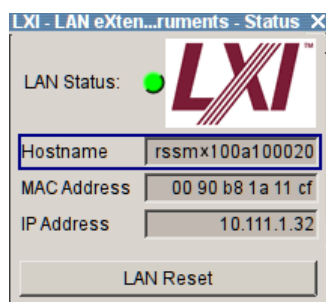

LAN Status

The LED indicates the LXI status.

The LAN Status is also indicated with the LED "LAN Status" on the front panel of the instrument.

"green"	normal operation
"green (flashing)"	device identification
"red"	LAN fault

Remote command:

n.a.

LAN Reset

Initiates the network configuration reset mechanism for the instrument and resets the hostname, MAC address, and IP address.

According to the LXI standard, a LAN Reset must place the following network settings to a default state:

Parameter	Value
TCP/IP Mode	DHCP + Auto IP Address
Dynamic DNS	Enabled
ICMP Ping	Enabled
Password for LAN configuration	LxiWebIfc

The LAN Reset for the R&S SMB also resets the following parameters:

Parameter	
Hostname	Instrument-specific host name
Description	RF and microwave signal generator
Negotiation	Auto Detect
VXI-11 Discovery	Enabled

The LAN settings are configured using the instrument's LXI Browser Interface described in [Chapter 2.8, "LXI Configuration"](#), on page 45.

To open the "Instrument Home Page" (welcome page), type the instrument's computer name (host name) or IP address in the address field of the browser on your PC, for example *http://10.111.10.175*.

Note: Do not add the missing zeros in the IP address, while opening the Instrument Home Page.

Remote command:
n.a.

5.2.3.17 Protection

This "Protection" dialog provides access to the unlocking of different protection levels .

Access:

- ▶ Select "Setup > Protection"

After power on the instrument, all protection levels are locked. To unlock the protection, the correct password must be entered, see ["To unlock or lock a protection level..."](#) on page 114.

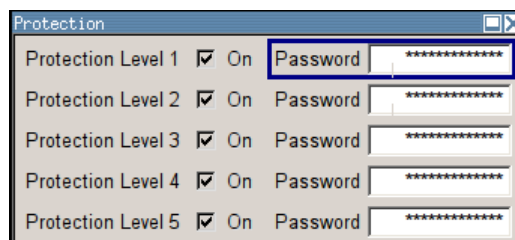

The following functions are protected in the respective levels:

- Protection Level 1
Protects against accidental changes to certain settings, e.g. clock and date, network settings or instrument names. You can access this protection level with the password *123456*.
- Protection Level 2
Provides access to the unlocking of protected service functions. It is accessible for authorized personnel of Rohde & Schwarz service departments.
- Protection Level 3-5
Are reserved for factory internal use.

To unlock or lock a protection level...

1. In the "Password" entry field, enter the password for the corresponding protection level.
2. Confirm with the ENTER key.
The checkbox of the protection level is disabled, i.e. the protection is unlocked.
3. To lock a protection level again, select the checkbox.

Protection Level/Password

Locks or unlocks the corresponding protection level.

E.g. protection level 1 expands the functionality of the internal adjustment and to access the selftests.

The password is 123456.

For access to service functions of protection level 2, see the service manual of your R&S SMB.

Remote command:

`:SYSTEM:PROTECT<ch>[:STATE]` on page 444

5.2.3.18 Security

The security concept of the R&S SMB helps you to protect your instrument against uncontrolled access and changes. All provided security services require that you enter the security password.

Provided security services are:

- **Password** management secures controlled user access to the instrument
With the two-step password concept, you can assign a user-defined password for the operating system, as well as a security password for accessing the mass storage of the instrument.
For more information concerning the security password, see the description *Resolving Security Issues when Working with an R&S SMB*. You can find this document on the R&S SMB product page at "Downloads" > "Manuals".
- **LAN Services** secures controlled network access.
You can individually lock and unlock the supported LAN interface services, see "[LAN Services](#)" on page 116.
Remote control via LAN interface requires that the interface is activated, but you can enable the required services specifically.
- **General** security parameters as:
 - **USB Storage** secures controlled access to the mass memory of the instrument.
 - **Write nonvolatile memory** protects against modification or deletion of data in the file system.
 - **Annotation** frequency and amplitude prevents reading the display.
 - **User Interface** prevents front panel operation and/or reading the display
 - **Bluetooth** enables operation of the instrument via Bluetooth.



Changing the password for the operating system or the security password requires that you enter the old password, the new password and that you confirm the new password.

To assign the password, press the "Accept" button. This action can not be undone!

Keep also in mind, that security settings are never reset, even if you perform a factory preset.

- ▶ To access this dialog, press the SETUP or MENU key and select "Protection " > "Security".

The "Security" dialog comprises the parameters for configuring the passwords, as well as the security settings of the mass storage and the LAN services.



The settings in this dialog will not be assigned until you enter the [Security Password](#) and confirm with the [Accept](#) button.

User Name

Indicates the user name used for access to the Linux operating system.

The user name and password are required for remote access to the instrument via VNC, FTP or SAMBA.

Change User Password

Allows you to change and confirm the user password.

Old Password ← Change User Password

Enters the current user password. The default password is "instrument".

Note: It is highly recommended to change the default user password before connecting the instrument to the network.

New Password ← Change User Password

Enters the new user password.

Confirm Password ← Change User Password

Confirms the new user password by repeating.

Note: The new password will not be assigned until you select the [Change Password](#) button.

Change Password ← Change User Password

Changes the user password accordingly.

Note: Keep in mind, that a changed password is never reset, even if you perform a factory preset.

Change Security Password

Enables you to change and confirm the security password.

Old Password ← Change Security Password

Enters the currently used security password. The default password is '123456'.

Note: It is highly recommended to change the default security password before connecting the instrument to the network.

The security password is required when changing the status of the USB and LAN interface.

New Password ← Change Security Password

Enters the new security password.

The security password may contain decimal characters only.

Confirm Password ← Change Security Password

Confirms the new password by repeating.

Note: The new password will not be assigned until you select the [Change Password](#) button.

Change Password ← Change Security Password

Changes the password accordingly.

Note: Keep in mind, that a changed password is never reset, even if you perform a factory preset.

LAN Services

Opens the "LAN Services" dialog for individually enabling or disabling the available LAN interface services.

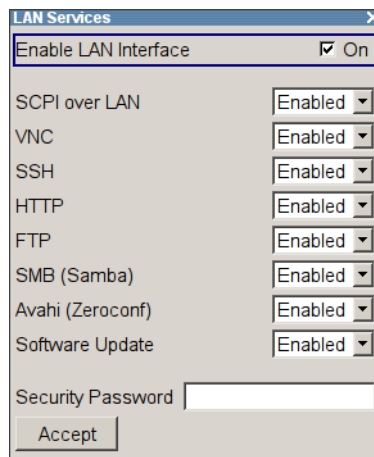

Enable LAN Interface ← LAN Services

Enables the LAN interface in general, and thus provides remote access via all unlocked services.

Note: The activated LAN services will not be assigned until you enter the [Security Password](#) and confirm with [Accept](#).

Enable LAN Services individually ← LAN Services

Enables or disables the following interface services individually.

"SCPI over LAN"

activates access over LAN to remotely control the instrument using SCPI (**S**tandard **C**ommands for **P**rogrammable **I**nstruments) commands.

"VNC"

activates access via VNC (**V**irtual **N**etwork **C**omputing) interface, a graphical desktop sharing system that uses RFB protocol to remotely control the instrument.

"SSH"

activates access via SSH (**S**ecure **S**hell), a network protocol for secure data communication.

"HTTP"

activates access via HTTP (**H**yper **T**ext **T**ransfer **P**rotocol), the application protocol for hypermedia information systems.

"FTP"

activates access via FTP (File Transfer Protocol), used to transfer files from a host to the instrument and vice versa.

"SMB (Samba)"

activates access to SMB (**S**erver **M**essage **B**lock), used for providing shared access to files, printers and serial ports of a network.

"Avahi (Zeroconf)"

activates Avahi, a service for automatic configuration of the instrument in a network environment.

"Software Update"

allows updating the instrument firmware via the LAN interface. For more information on this topic see the release notes of the instrument, provided on the Internet at the download site or the Rohde & Schwarz Signal Generator home page.

USB Storage

Activates the access to external USB storage media.

This setting has no effect on a mouse or a keyboard, connected via USB.

Note: The setting will not be assigned until you enter the [Security Password](#) and confirm with [Accept](#).

Write Nonvolatile Memory

Activates write protection on the file system to prevent modification or erasure of valuable data.

Note: The setting will not be assigned until you enter the [Security Password](#), confirm with [Accept](#), and reboot the instrument.

Annotation Frequency

Enables/disables the display of the currently used frequency in the header of the instrument.

Note: The setting will not be assigned until you enter the [Security Password](#) and confirm with [Accept](#).

Remote command:

[:DISPlay:ANNotation:FREQuency](#) on page 291

Annotation Amplitude

Enables/disables the display of the currently selected level in the header of the instrument.

Note: The setting will not be assigned until you enter the [Security Password](#) and confirm with [Accept](#).

Remote command:

[:DISPlay:ANNotation:AMPLitude](#) on page 290

User Interface

Allows you to lock the manual of the controls of the instrument, and to hide even the entire display.

The setting requires the entry of the security password *123456* and is only accepted after the "Accept" button is pressed.

Tip: Section ["Enabling a locked user interface for manual operation"](#) on page 119 describes how you can unlock the control elements and the user interface.

- | | |
|------------|---|
| "Enabled" | Enables the display and all controls for the manual operation of the instrument. |
| "VNC Only" | Locks the keys at the front panel and externally connected keyboard and mouse.
The display on the screen remains and shows the current settings and changes.
Unlocking is possible via VNC or turning off and on again. |

"Display only"

Locks the manual operation of the instrument. The display on the screen remains and shows the current settings and changes. This security feature protects the instrument against unauthorized access, but still shows the current settings and processes, for example when you operate the instrument via remote control.

The function disables:

- the keys at the front panel of the instrument
- the external mouse and keyboard

The instrument indicates the locked controls by a padlock  softkey in the taskbar.

"Disabled"

Locks the display and all controls for the manual operation of the instrument.

This security feature protects the instrument against unauthorized reading and access, for example when you operate the instrument via remote control.

The function disables:

- the display
- the keys at the front panel of the instrument
- the external mouse and keyboard

The screen shuts off and shows a padlock instead.



Remote command:

:SYSTem:ULOCK on page 437

:SYSTem:DLOCK on page 436

:SYSTem:KLOCK on page 436

Enabling a locked user interface for manual operation

To unlock the user interface for manual operation you have the following options:

- On the instrument's keypad or external keyboard, enter the security password *123456*.

Even if you press any key, the instrument prompts you to enter the security password for unlocking.

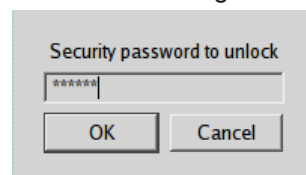

Note The character of the first key you pressed is immediately added in the input field. Prior to inserting the password delete this entry.

- In remote control mode, send the command `SYST:ULOCK ENABled` to release all locks at once.

Alternatively, you can use the command `SYST:KLOCK OFF` to unlock the keyboard, or `SYST:DLOCK OFF` to release the display.

Via remote control, there is no password required.

Remote command:

:SYSTem:ULOCK on page 437

:SYSTem:DLOCK on page 436

:SYSTem:KLOCK on page 436

Security Password

Enters the password that is required to enable or to disable the settings protected by a security password. Default is '123456'.

Note: It is highly recommended that you to change the default security password before connecting the instrument to the network.

All settings are only accepted after the "Accept" button is pressed.

Accept

Applies the modified settings, provided the security password is entered correctly.

Note: This action can not be undone. Keep in mind, that a changed password is never reset, even if you perform a factory preset.

Bluetooth Pin

Sets the Bluetooth pin of an external Bluetooth device. The pin is required to enable remote control via an external Bluetooth device.

Requires a Bluetooth adapter (recommended extra, see data sheet) .

5.2.3.19 Save/Recall

The "Save/Recall" submenu can also be called up with the FILE key and is therefore described in the section of this key (see [Chapter 5.2.8, "Storing and Loading Instrument Data - File Key"](#), on page 126).

5.2.3.20 Factory Preset

The "Factory Preset" dialog provides a function to reset the instrument's settings to their factory state. This function is activated by pressing the "Execute Factory Preset" button.

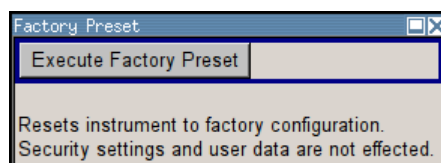

Factory Preset

Reset the instrument's settings to their factory state.

Note: "Factory Preset" resets the "Remote Channel" and network settings to the default values.

Executing "Factory Preset" via remote control terminates the connection to the instrument, if these settings had been configured to values different to the default ones.

The factory preset function resets nearly all instrument settings. In addition to the regular preset by means of the PRESET key, a "Factory Preset" resets also the following values:

- Reference frequency settings ("Ref Oscillator" menu)
- Power on settings ("Level/EMF" menu)
- Network settings including hostname ("Setup" menu)
- Remote channel settings including GPIB address ("Setup" menu)
- Start/Stop display update ("Setup" menu)
- Display and keyboard settings ("Setup" menu).

To maintain security, password settings and all settings protected by these passwords like disabled USB and LAN connections are not changed.

Not affected by the "Factory Preset" are also user data, lists or instrument settings files, created for example by means of the Save/Recall function.

Remote command:

:SYSTem:FPReset on page 285

5.2.3.21 Help

The "Help" dialog offers comprehensive online help for the R&S SMB. A desired topic can be selected via the table of contents (select "Manual") or the index (select "Index").

For context-sensitive information about a marked parameter, press the HELP key. For a description of the "Help" menu, refer to the section covering to the HELP key (see [Chapter 5.2.7, "Help System - Help Key"](#), on page 125).

5.2.4 Switching to Manual Control - Local Key

The local key switches from remote control to manual control (local state).

In remote control mode the instrument indicates the remote state in the display header. The rest of the display remains unchanged and shows the current instrument status, that means the status which exists under the remote control settings. The instrument can be operated (for example dialogs can be opened). However, it is not possible to enter or change values.

The status message additionally indicates whether the LOCAL key is disabled or enabled.

The following states are indicated:

- "REMOTE"
The LOCAL key switches the instrument from remote control to manual control. The current command must be fully processed before the mode is switched, otherwise the instrument switches immediately back to remote control.
- "REM-LLO"
The LOCAL key is locked, initiated by the &LLO (local lockout) command. The instrument can be switched from remote state to local state only via remote control, for example with >R or the Visual Basic command CALL IBLOC (generator%). The LOCAL key has previously been locked by the remote command &LLO.

When switching from remote to manual control, the display update function is automatically deactivated ("SETUP" > "Start/Stop Display Update" > "Off").

5.2.5 Generating a Hard Copy of the Display

The save/recall function enables you to store the settings in a file. In addition, you can create a hard copy of the current display to save the most important settings of a performed signal generation in an image file.

5.2.5.1 Hard Copy Settings

Creating a hardcopy of the display requires that you have an external keyboard connected to the instrument.

- To access the dialog, use the key combination CTRL+Z, or CTRL+Y depending on the used keyboard settings.

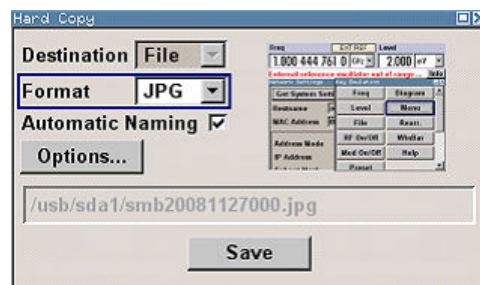

The dialog contains the parameters for configuring the output format and location of a hardcopy.

The remote commands required to define the hard copy settings are described in [Chapter 7.8, "HCOPY Subsystem"](#), on page 294.

Destination

Indicates that the hardcopy is stored in a file (see also ["File Options"](#) on page 123).

Remote command:

:HCOPY:DEVIce on page 295

Options

Opens the "Hardcopy Options" dialog for configuring the corresponding parameters (see ["File Options"](#) on page 123).

Remote command:

n.a.

File

Some configuration parameters are already offered in the Hardcopy dialog. All configuration parameters are available in ["File Options"](#) on page 123.

Automatic Naming

Activates automatic generation of the file name. Automatic naming is configured in the "Options..." sub dialog, see "File Options" on page 123.

Remote command:

`:HCOPY:FILE[:NAME]:AUTO:STATE` on page 301

File Info

Indicates the file name. The file name can be entered either manually via the file manager (button "File...") or generated automatically (Automatic naming checkbox). Automatic naming is configured in the "Options..." submenu.

Remote command:

`:HCOPY:FILE[:NAME]` on page 296

`:HCOPY:FILE[:NAME]:AUTO:FILE?` on page 297

5.2.5.2 Hardcopy Options

This section describes the "Hardcopy Options" dialog.

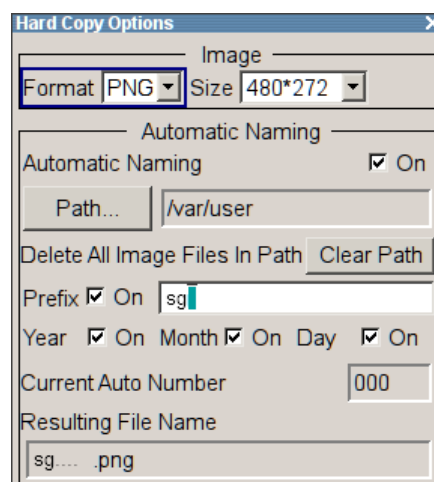
**File Options**

Dialog for setting the file parameters.

"Format" Selects the output file format, for example * .bmp, * .jpg* .xpm* .png.

Remote command:

`:HCOPY:IMAGE:FORMAt` on page 301

`:HCOPY:DEVIce:LANGUage` on page 296

"Automatic Naming" If enabled, creates the output filenames automatically according to rules following the activated components.

"Path..." Selects the directory.

Note: To select the destination path, you have to specify a file name as well. Otherwise an error message is displayed and the selection is canceled.

Directory, path and file name are displayed in the infoline right to the "Path" button.

Remote command:

`:HCOPY:FILE[:NAME]:AUTO:DIRectory` on page 297

`:HCOPY:FILE[:NAME]:AUTO?` on page 297

"Clear Path" Deletes all image files with extensions `bmp`, `img`, `png`, `xpm` and `csv` in the directory set for automatic naming.

Before deleting the image files a warning message is displayed requiring the confirmation.

Remote command:

`:HCOPY:FILE[:NAME]:AUTO:DIRectory:CLEar` on page 297

"Prefix, Year, Month, Day" Determines the rules for "Automatic Naming".

Per default, the automatically generated file name is composed of: `<Path>/<Prefix><YYYY><MM><DD><Number>.<Format>`, where `Y`, `M` and `D` mean Year, Month, Day; `Number` is the "Current Auto Number".

You can deactivate/activate each component separately.

The "Resulting File Name" indicates the current file name syntax.

Remote command:

`:HCOPY:FILE[:NAME]:AUTO[:FILE]:PREFix:STATe` on page 300

`:HCOPY:FILE[:NAME]:AUTO[:FILE]:PREFix` on page 300

`:HCOPY:FILE[:NAME]:AUTO[:FILE]:YEAR:STATe` on page 300

`:HCOPY:FILE[:NAME]:AUTO[:FILE]:MONTH:STATe` on page 299

`:HCOPY:FILE[:NAME]:AUTO[:FILE]:DAY:STATe` on page 298

"Current Auto Number" Indicates the number which is used in the automatically generated file name.

Note: When initially switching on the instrument the number is reset to the lowest possible value. Starting with number 0 the output directory is scanned for already existing files. As long as files with the same name are existing the number is increased by 1. The number is automatically set so that the resulting file name will be unique within the selected path. The current number is not in the save/recall file but will be temporarily stored within the database. At following save operations the number is increased.

Remote command:

`:HCOPY:FILE[:NAME]:AUTO[:FILE]:NUMBer?` on page 299

"Resulting File Name" Indicates the automatically generated file name.

Remote command:

`:HCOPY:FILE[:NAME]:AUTO:FILE?` on page 297

Save

Stores the hardcopy.

Remote command:

[:HCOpy \[:EXECute \]](#) on page 296

5.2.6 Messages - Info Key

The INFO key opens a window containing a detailed description of every message displayed in the info bar, see [Chapter 4.2.3, "Info Window"](#), on page 69 and [Chapter 9, "Status Information, Error Messages and Troubleshooting"](#), on page 481.

5.2.7 Help System - Help Key

The HELP key opens a browser window containing a context-sensitive description of the highlighted parameter.

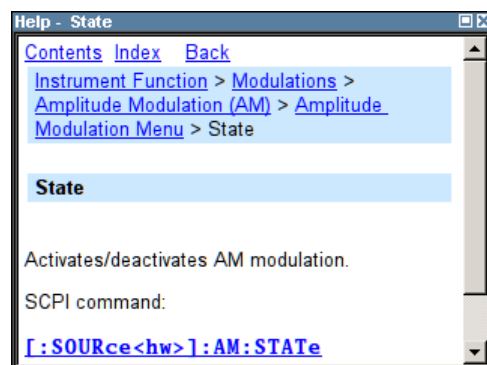

The context-sensitive page which is opened with the HELP key is part of a comprehensive help system. It is possible to move from this context-sensitive page to any page of the help system. The following navigation aids are available:

- Internal links in the text
They open pages which are directly linked to the described function. In this way it is possible, for example, to call up the description of the GPIB command for any particular function.
- Back
The "Back" button calls up the page last viewed.
- Contents in the navigation panel
The contents list is used to open the individual help pages. It has a hierarchical structure. The highlighted line indicates where the currently displayed page is within the contents list.
- Index in the navigation panel
The index is used to call up all pages which contain the selected entry. The index has an alphabetical structure and also contains all GPIB commands.
- Find

The find function allows you to look for freely selectable terms in all help pages. A list of the pages containing the entered term is displayed as the search result. The search can be limited to words in the page title to increase the number of hits.

5.2.8 Storing and Loading Instrument Data - File Key

The R&S SMB allows complete instrument settings to be stored in files either on the internal flash memory or on external USB memory devices.

Defined and complex instrument settings can then be reproduced at any time by loading this data. If required, these settings can be loaded to various signal generators.

The corresponding menu is available under "Save/Recall" in the "Setup" menu. The instrument settings are saved in files which can be stored in data directories.

Additionally there are intermediate memories in which the current instrument setting can be stored and then called up again by just pressing a key. This provides fast switching between different instrument settings.

Only settings which differ from the preset values and configuration data for the operating elements (e.g. window positions) are stored. As a result the files remain relatively small. Furthermore, instrument settings can easily be transferred between different equipped signal generators since the files contain only relevant information. When loaded, the referenced settings are implemented and all non-referenced parameters are set to the associated preset values.

If list data is part of the instrument settings, e.g. a list of user correction data, a reference to this list is stored, not the list itself. The list is reactivated when the associated settings are loaded, but the list may have been modified or deleted in the meantime or may not be available on a different instrument. If the list has been modified, the new entries will be used. An error message appears if an attempt is made to access a non-existing list or to activate settings which are not supported by the instrument.



- Network settings and remote settings are not saved and restored.
 - Lists are stored and loaded in the appropriate menus. For example, the user correction data list is created and stored in the "User Correction" menu.
-

When loading an instrument setting, it is possible to select whether the current frequency and level setting is to be retained or whether the stored settings are to be activated. It is possible to delete stored instrument settings. A file can be copied by loading it with "Recall" and then storing it under a new name.

Settings can be transferred easily between instruments with different equipment options and/or firmware versions because only the settings which differ from the preset values are affected. When settings are loaded, only those which are possible on the instrument are implemented. Error messages indicate the settings which cannot be implemented.

The stored file is transferred from one instrument to another using the memory stick.

General file management functions such as copying and moving data are available in the "File Manager" dialog.

5.2.8.1 Save/Recall Menu

The settings available in the File menu "Save/Recall" depend on the operation selected under "Select Operation".



For more information, see [Chapter 4.7.1, "File Select Dialog"](#), on page 84.

Select Operation

Selects the file function.

Accesses the settings for storing ("Save") and loading ("Recall") of the instrument settings.

"Save..." Calls the menu for storing the current instrument setting (see [Chapter 5.2.8.2, "Storing Instrument Settings"](#), on page 127).

"Recall..." Calls the menu for calling up a stored instrument setting (see [Chapter 5.2.8.3, "Loading Instrument Settings"](#), on page 128).

5.2.8.2 Storing Instrument Settings

If "Save" is selected under "Select Operation", the File menu provides options for storing the current instrument setting in a file.

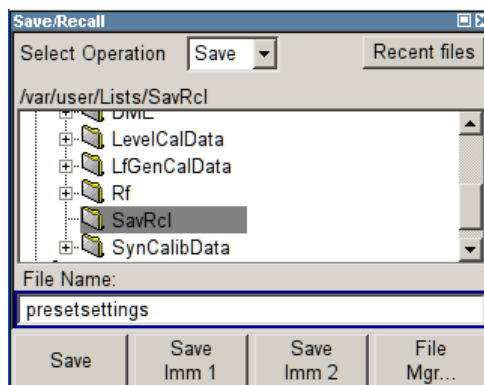

Recent files

Displays the files last used.

Directory, File List and File Name

Note:

You access this generic standard function each time you perform one of the following:

- store or load (settings) files
- define a folder these files are to be stored in or
- navigate through the file system.

The name of the dialog is context sensitive but the provided functions are self-explanatory and very similar.

With the provided settings, you can perform the following:

- to navigate through the file system, use the directory tree
- to load and store files, use the dedicated functions "Select", "Save" and [Recent files](#)
- to perform standard file management functions, like create new directories, move, copy, delete files and/or directories, use the standard "File Manager" function (see ["File Manager"](#) on page 128).

Remote command:

to list all files in a directory:

[:MMEMory:CDIRectory](#) on page 306

[:MMEMory:CATalog?](#) on page 306

[\[:SOURce\]:CORRection:CSET:CATalog?](#) on page 329

Save

Stores the current instrument settings under the specified path.

Remote command:

[*SAV](#) on page 283

[:MMEMory:STORe:STATe](#) on page 311

Save Immediate x

Stores the current instrument setting in one of the three intermediate memories.

These instrument settings are retained until a different instrument setting is stored in the intermediate memory. When the instrument is switched off, the contents of the intermediate memories are retained.

Remote command:

[*SAV](#) on page 283

File Manager

Accesses the "File Manager" dialog, see [Chapter 5.2.8.4, "File Manager"](#), on page 130.

Remote command:

n.a.

5.2.8.3 Loading Instrument Settings

If "Recall" is selected under "Select Operation", the "File" menu provides options for loading complete instrument settings. Here it is possible to select whether the current or stored frequency and level settings are to be used.

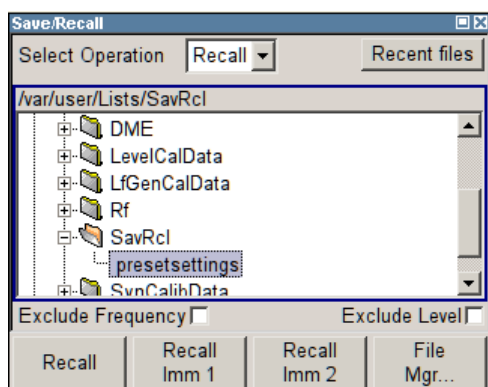

Recent files

Displays the files last used.

Directory, File List and File Name

Note:

You access this generic standard function each time you perform one of the following:

- store or load (settings) files
- define a folder these files are to be stored in or
- navigate through the file system.

The name of the dialog is context sensitive but the provided functions are self-explanatory and very similar.

With the provided settings, you can perform the following:

- to navigate through the file system, use the directory tree
- to load and store files, use the dedicated functions "Select", "Save" and [Recent files](#)
- to perform standard file management functions, like create new directories, move, copy, delete files and/or directories, use the standard "File Manager" function (see ["File Manager"](#) on page 128).

Remote command:

to list all files in a directory:

`:MMEMory:CDIRectory` on page 306

`:MMEMory:CATalog?` on page 306

`[:SOURce] :CORRection:CSET:CATalog?` on page 329

Exclude Frequency

The current frequency is retained when a stored instrument setting is loaded.

Remote command:

`[:SOURce<hw>] :FREQuency [:CW | FIXed] :RCL` on page 342

Exclude Level

The current level is retained when a stored instrument setting is loaded.

Remote command:

`[:SOURce<hw>] :POWER [:LEVel] [:IMMediate] :RCL` on page 380

Recall

Load the selected configuration.

If an instrument setting in which a sweep was activated is stored, the sweep is started when the recall command is called.

If an instrument setting which accesses lists is stored, this list is also loaded.

If the list has been deleted in the meantime, an error message appears when the instrument setting is loaded. If the list has been overwritten in the meantime, the new entries will be used.

Remote command:

[:MMEMory:LOAD:STATe](#) on page 309

[*RCL](#) on page 282

Recall Immediate x

Loads the selected configuration from one of the three intermediate memories.

If an instrument setting in which a sweep was activated is stored, the sweep is started when the recall command is called.

If an instrument setting which accesses lists is stored, this list is also loaded.

If the list has been deleted in the meantime, an error message appears when the instrument setting is loaded. If the list has been overwritten in the meantime, the new entries will be used.

A message appears if no instrument configuration is stored in this memory.

Remote command:

[*RCL](#) on page 282

File Manager

Accesses the "File Manager" dialog, see [Chapter 5.2.8.4, "File Manager"](#), on page 130.

Remote command:

n.a.

5.2.8.4 File Manager

The "File Manager" is a tool very similar to a standard Windows Explorer and helps you manage mass storage media and files stored on the R&S SMB.

You can perform the following tasks:

- Copying multiple files from disk to other media and vice versa, see [Chapter 5.2.8.5, "Accessing the File System of the Instrument and Transferring Files from and to the Instrument"](#), on page 132
- Copying files into another directory, see [Copy](#) and [Paste](#)
- Renaming and deleting files, see [Rename](#) and [Delete](#)
- Creating new directories on the following drives:
 - hard disk
 - internal flash memory
 - memory stick

See [Create New Directory](#)

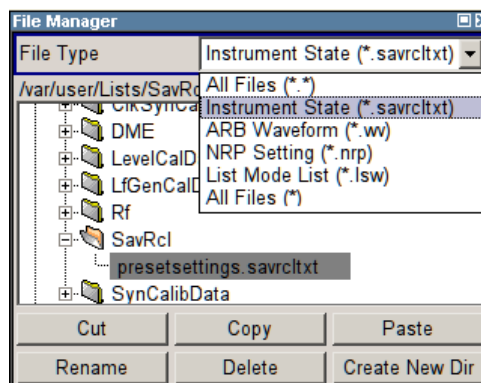

For more information, see [Chapter 4.7.2, "File Manager"](#), on page 85.

File Type

Selects the file type to be listed. If you select a file type with a specific file extension, only files with this extension are listed in the directory.

Remote command:

n.a.

Directory and File Name

Selects the directory in which the file to be deleted or copied is located. The dialog lists all files in this directory. Selected files are highlighted. The path is indicated above the directory window.

Unlike the "Save/Recall" and "File Select" dialogs, the "File Manager" displays the full file names including extensions.

Remote command:

[:MMEMory:CDIRectory](#) on page 306

Cut

Cuts the selected file. It can be pasted into a different directory using the "Paste" button.

Remote command:

[:MMEMory:DELeTe](#) on page 309

Copy

Copies the selected file. It can be pasted into a different or the same directory using the "Paste" button. When pasting the file into the same directory file name `Copy of <file name>` is given automatically. When pasting the file into a different directory, the original file name is kept.

Remote command:

[:MMEMory:COpy](#) on page 307

Paste

Pastes the file that has been copied or cut before.

Remote command:

n.a.

Rename

Renames the selected file or directory. The new name can be entered in the "New File-name" dialog.

Remote command:

[:MMEMory:MOVE](#) on page 310

Delete

Deletes the selected file. Before the file is deleted, a message appears prompting the user to confirm deletion of the file.

Remote command:

[:MMEMory:DELeTe](#) on page 309

Create New Directory

Creates a new directory. The name of the new directory can be entered in the "New Directory" dialog.

Note: When the subdirectory is entered, it is possible to enter an absolute path name (e.g. `/var/MEAS`) or the path relative to the current directory (e.g. `../MEAS`).

The directory is created as a subdirectory in the selected level.

Remote command:

[:MMEMory:MDIRectory](#) on page 310

5.2.8.5 Accessing the File System of the Instrument and Transferring Files from and to the Instrument

To access files and the file system of the instrument or to use the general file management functions such as copying and moving data, use the standard "File Manager" dialog.

To transfer files from and to the instruments or to exchange files, use one of the following alternatives:

- Connect a memory stick to one of the USB interfaces.
The instrument recognizes automatically a connected memory stick.
- Connect the instrument to a LAN.
For information on how to set up a LAN connection, refer to [Chapter 2.6, "Setting Up a Network \(LAN\) Connection"](#), on page 34.

An instrument connected to a LAN supports the standard file transfer methods from a remote client:

- FTP (file transfer protocol)
see ["To access the file system of the R&S SMB via ftp"](#) on page 133
- File sharing according to the SAMBA/SMB (server message block) protocol
see ["To access the file system of the R&S SMB via SMB \(Samba\)"](#) on page 134

Both file transfer methods access the folder `/var/user/share`.

This section provides an introduction to this topic. For comprehensive information, refer to the Application Note 1GP72 "Connectivity of Rohde&Schwarz Signal Generators".

To access the file system of the R&S SMB via ftp

If the R&S SMB is connected to a LAN and the required configurations are completed, you can use File Transfer Protocol (ftp) to access the file system and to transfer files from and to the instrument.

1. Connect the instrument and the remote PC to a LAN.
2. Find out the "IP Address" of the instrument:
 - a) Select "Setup > Environment > Network Settings".
 - b) Write down the "IP Address" of the instrument, e.g. *10.113.10.105*.
3. On the remote PC, start the Windows Explorer.
4. In the address field, enter `ftp://<"IP Address" of the Instrument>`, e.g. `ftp://10.113.10.105`

A log on dialog opens and requests a password.

Tip: Default password. The FTP file access use the user *instrument* with default password *instrument*.

It is highly recommended that you change the user password in the "Security" dialog before connecting the instrument to the network!

See [Chapter 5.2.3.18, "Security"](#), on page 114.

5. Enter the password to access the `/var/user/share` directory.

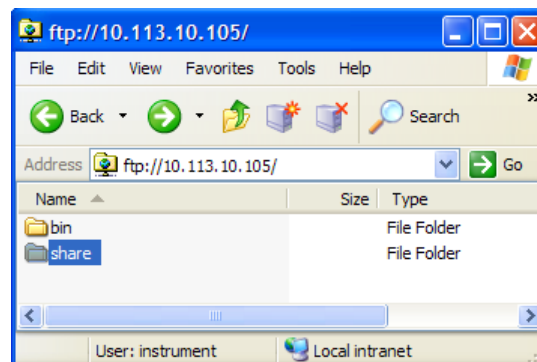

You can access the files in the `/var/user/` directory, perform standard function like creating directory, etc.

6. Open the `/var/user/share` directory and create a new directory, e.g. `testftp`.
7. On the instrument, press the FILE key and open the `/var/user/share` directory. The dialog displays the `testftp` directory.

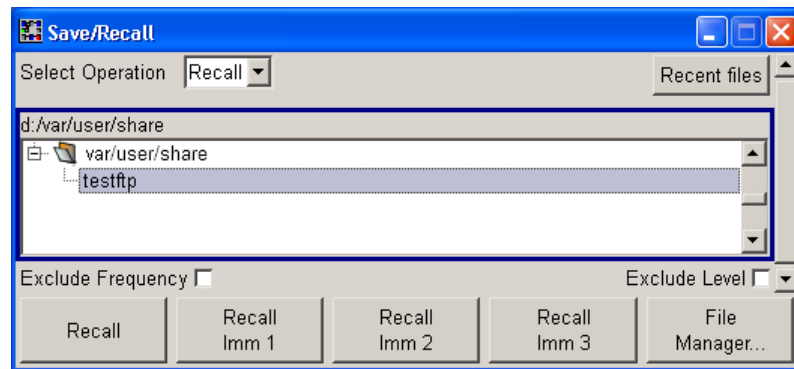

To access the file system of the R&S SMB via SMB (Samba)

The SMB (Samba) protocol is an alternative way to access the file system of the instrument from a remote PC, if both the instrument and the PC are connected to a LAN.

1. Connect the instrument and the remote PC to a LAN.
2. Find out the "IP Address" of the instrument:
 - a) Select "Setup > Environment > Network Settings".
 - b) Write down the "IP Address" of the instrument, e.g. *10.113.10.105*.
3. On the remote PC, start the Windows Explorer and open the "Map Network Drive" dialog.
 - a) Select a valid "Drive", e.g. *W*.
 - b) In the "Folder" field, enter:
`//<"IP Address" of the Instrument>/share` or
`//<"Hostname" of the Instrument>/share`, e.g. `//10.113.10.105/share`
 - c) Select "Finish".

A log on dialog opens and requests an user name and a password.

4. Enter the user name and the password of your instrument.
The default user name and password is *instrument*.

Tip: Default password. The SAMBA/SMB file access use the user *instrument* with default password *instrument*.

It is highly recommended that you change the user password in the "Security" dialog before connecting the instrument to the network!

See [Chapter 5.2.3.18, "Security"](#), on page 114.

The `/var/user/share` directory of the instrument is mapped to and displayed as a network drive of the remote PC.

You can access the files in this directory, perform standard function like creating directory, storing files, etc.

5.3 RF Block

5.3.1 Overview of RF Signal

Settings for the RF output signal and analog modulation are made under "RF Signal". These settings can be accessed in the block diagram by way of the "RF" function block, or by means of the menu with the same name which is opened using the MENU key.

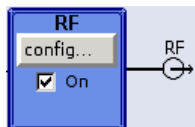

The function block is available for the basic unit (R&S SMB + frequency option) without additional equipment options.

5.3.1.1 RF Output

Basically, the RF output signal is deactivated. The previous state is restored, when the signal is reactivated.

Activating RF Signal Output

If the settings for the RF signal are done, you can activate RF signal output via:

- the RF ON/OFF key (the current entry focus is irrelevant)
- the checkbox in the "RF" block (see "RF On" on page 135)
- the "RF Frequency > RF ON" checkbox in the RF block (see "RF Output State" on page 136).

To open the menu, select the "Configure" button in the RF block.

The current state of the RF output (activated and deactivated) is indicated in the block diagram by means of the different block color and the status of the "On" checkbox.

An active sweep is also indicated in the block.



To query the impedance of the RF outputs, use the command `:OUTPut<hw>:IMPedance?` on page 314.

RF On

Activates RF signal output.

This function corresponds to the RF ON /OFF key.

See also [Chapter 5.3.1.1, "RF Output"](#), on page 135.

Remote command:

`:OUTPut<hw> [:STATe]` on page 314

RF Output State

Activates the RF output signal by selecting the RF checkbox in the "Configure" dialog of the "RF" block.

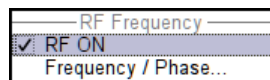

Remote command:

`:OUTPut<hw> [:STATe]` on page 314

5.3.1.2 RF Signal Modes and Characteristics

- **CW**
The RF signal is generated with the set frequency and level. This is the default mode.
- **Sweep**
The RF signal is generated as a sweep with the set parameters. It is not possible to activate frequency, level and LF sweep simultaneously.
- **List Mode**
The RF signal is generated on the basis of a list of predefined frequency and level values. The duration of the individual steps can be predefined.

Instruments connected downstream can be taken into consideration when setting the frequency and level by entering a frequency and/or level offset.

Automatic level control ("ALC") ensures maximum level accuracy.

User-specific lists which contain level correction values for any frequency range ("User Correction") can be created to, for example, compensate the cable attenuation in a test assembly setup.

The R&S SMB generates the RF signal in unmodulated or analog form. The signal generator is equipped therefore with the following sources for analog modulations:

- an internal LF generator
- an internal pulse generator
- the external modulation inputs MOD EXT and PULSE EXT.

An external trigger signal for the sweeps and the LIST mode can be provided at the INST TRIG input.

The input REF IN is used to input an external instrument reference, and the output REF OUT serves as the output of the reference frequency (internal or external).

5.3.2 RF Frequency

The value of the RF frequency is displayed in the header of the display ("Freq"). This field provides the direct input of the RF frequency. Alternatively, you can enter the RF frequency in the "Frequency/Phase" dialog.



Note that the displayed RF frequency in the header, and the RF output frequency, entered in the "Frequency/Phase" dialog can be different, as explained in the following section.

5.3.2.1 RF Frequency vs. RF Output Frequency

If you are working with a downstream instrument, e.g. a mixer or a frequency multiplier, you can enter the related parameter value in the frequency settings dialog ("Offset", "Multiplier").

The generator includes these parameters and displays the result in the "Freq" field in the status bar, as if the downstream instrument and the generator were one unit. This displayed frequency corresponds to the value at the RF output of the downstream instrument. However, the frequency provided at the RF output of the signal generator corresponds to the frequency value set in the "Frequency/Phase" dialog.

The instrument activates the "Freq Offset" icon in the status bar, when a frequency offset or multiplication factor is set.

The correlation between the RF frequency, the RF output frequency and the frequency offset is as follows:

"Freq" (in header) = "RF output frequency" (Frequency in dialog) * "Multiplier" factor (Multiplier in dialog) + "Freq offset" (Offset in dialog)

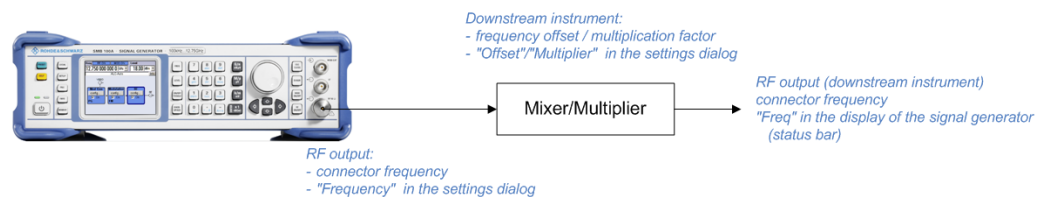

If you have the R&S SMB equipped with one of the microwave frequency options R&S SMB-B112, -B120, or -B140, you can, in addition, operate an R&S SMZxx frequency multiplier.

xx represents the multiplier type that you can use according to the target frequency range.

5.3.2.2 Setting the RF Frequency

To change the RF frequency, press the **FREQ** key and enter the desired frequency. Changes to the RF frequency have an immediate effect (without confirmation with the **ENTER** key) on the output signal.

RF Freq

Enters the RF frequency, considering the frequency offset.

Note: The SCPI command sets the level of the "Freq" display, that means an entered frequency offset and multiplier factor are considered in the frequency value.

Remote command:

[:SOURce<hw>] :FREQuency [:CW|FIXed] on page 341

5.3.2.3 RF Frequency Dialog

The combined "RF Frequency / Phase..." dialog contains the parameters required for configuring the frequency and settings like a frequency offset, or a multiplier factor of an externally connected multiplier, see [Chapter 5.3.2.4, "Frequency Settings"](#), on page 138.

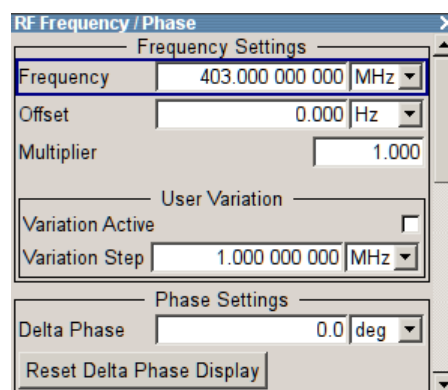

Furthermore, the dialog provides additional settings parameters which are described in:

- [Chapter 5.3.3, "Phase"](#), on page 140

5.3.2.4 Frequency Settings

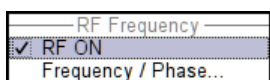

Access:

- ▶ Select "RF > config... > RF Frequency > Frequency/Phase".

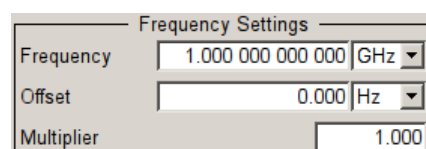

In the upper section of the combined "RF Frequency / Phase ..." settings dialog, you can configure the frequency of the RF signal.

The remote commands required to define the settings are described in [Chapter 7.13.4, "SOURce:FREQuency Subsystem"](#), on page 340.

Frequency

Sets the RF frequency of the RF output connector. The frequency entered and displayed here corresponds to the frequency at the RF output, that means any offset entry is not considered.

Note: Suppressed values in the status bar

For security concerns or certain operating modes you can hide the frequency and level display in the status bar.

- 

The display has been disabled for security reasons, see [Annotation Frequency](#) and [Annotation Amplitude](#).

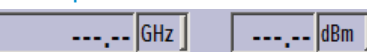
- 

The display is disabled when list mode is running, see ["State - List Mode"](#) on page 189.

Remote command:

[\[:SOURce<hw>\]:FREQuency\[:CW|FIXed\]](#) on page 341

Note: This command sets the frequency of the "FREQ" display, that is the frequency containing offset and multiplier.

Offset

Sets the frequency offset relative to the RF frequency. The frequency offset of a downstream instrument (for example a mixer) is entered.

The entry does not change the value of the RF frequency at the RF output. It only changes the RF frequency displayed in the display header. The value of the RF frequency in the header corresponds to the frequency at the output of the downstream instrument, see also [Chapter 5.3.2.1, "RF Frequency vs. RF Output Frequency"](#), on page 137.

Remote command:

[\[:SOURce<hw>\]:FREQuency:OFFSet](#) on page 344

Multiplier

Sets the multiplication factor for the RF frequency.

In the frequency field of the status bar, the instrument adjusts its frequency display according to the set multiplication factor. This frequency value shows the frequency at the output of the downstream multiplier. The entry does not change the RF frequency at the RF output of the R&S SMB, see also [Chapter 5.3.2.1, "RF Frequency vs. RF Output Frequency"](#), on page 137.

Remote command:

[\[:SOURce<hw>\]:FREQuency:MULTiplier](#) on page 344

5.3.2.5 User Variation Settings

Access:

- ▶ Select "RF > config... > RF Frequency > Frequency/Phase".

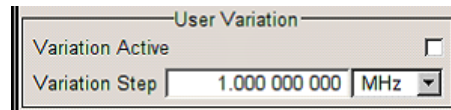

The combined "RF Frequency / Phase ..." settings dialog contains the parameters determine the step size for adjusting the frequency with the rotary knob.

Variation Active

Activates the user-defined step width used when varying the frequency value with the rotary knob.

- "ON" The frequency value set with the rotary knob is varied using the user-defined step width which is entered under "Variation Step".
- "OFF" The frequency value set with the rotary knob is varied in steps of one unit at the cursor position (standard operating mode).

Remote command:

[\[:SOURce<hw>\]:FREQuency:STEP:MODE](#) on page 347

Variation Step

Sets the user-defined step width. This step width is used when entering the RF frequency using the rotary knob. Frequency variation with this step width must also be activated with "Variation Active".

Remote command:

[\[:SOURce<hw>\]:FREQuency:STEP\[:INCRement\]](#) on page 346

5.3.3 Phase

The phase of the RF output signal can be changed in the "Phase Settings" section of the "RF Frequency/Phase" dialog.

5.3.3.1 Phase Settings

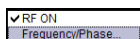

- ▶ To access the dialog for configuring the phase settings, perform one of the following:

- Select "RF > config... > RF Frequency > Frequency/Phase".
- Press the MENU key and select "RF > RF Frequency > Frequency/Phase".

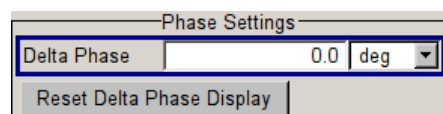

The combined "RF Frequency / Phase ..." settings dialog contains the parameters to configure the phase settings of the RF signal.

The remote commands required to define the settings are described in [Chapter 7.13.10, "SOURce:PHASe Subsystem"](#), on page 372.

Delta Phase

Sets the phase of the RF signal. The current phase of the signal is used as the reference. This function allows, for example, the phase of the output signal to be synchronized with the phase of a signal from a second signal generator.

Remote command:

[:SOURce<hw>] : PHASe on page 372

Reset Delta Phase Display

Resets delta phase value. The set phase is adopted as the new current phase, i.e. the delta phase value is reset to 0.

Remote command:

[:SOURce<hw>] : PHASe:REFeRence on page 373

5.3.4 Reference Oscillator

The R&S SMB is equipped with an internal reference oscillator that generates a reference frequency of 10 MHz. It is used as internal reference source for the synthesizer and the local oscillator. Alternatively, you can apply an external reference signal.

Regardless of the used reference source (internal or external), the R&S SMB always provides the configured reference frequency at the output. You can use it, for example to synchronize several interconnected instruments.



The settings of the reference oscillator are not affected by an instrument preset ("PRE-SET" key).

The following examples briefly explain the possible test setups and the settings to be considered.

- Internal $f_{\text{ref}} = 10 \text{ MHz}$ (10 MHz REF OUT)

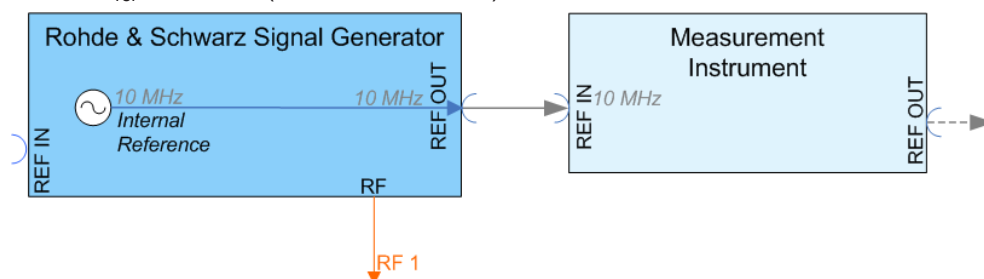

Figure 5-1: Synchronizing a subsequent instrument using the internal 10 MHz reference signal of the R&S SMB

The internal reference oscillator supplies the reference frequency.

Settings:

- Source: "Internal"
- External $f_{\text{ref}} = 10 \text{ MHz}$ (10 MHz REF OUT)
If you have a clean external reference signal with 10 MHz frequency, you can directly pass it to the output. The signal quality remains the same.

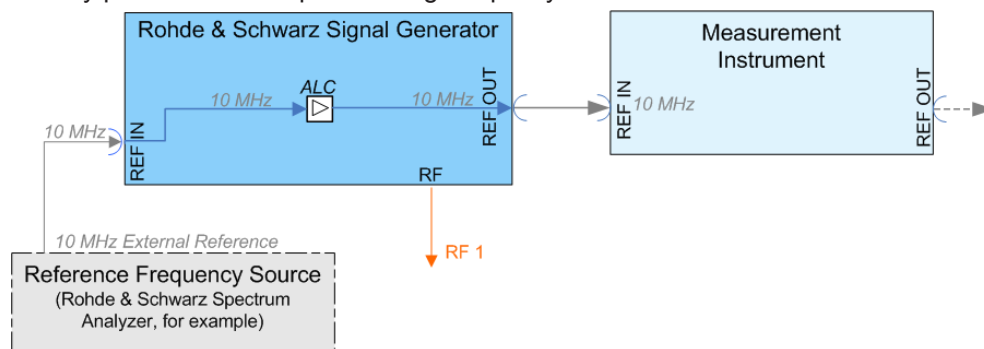

Figure 5-2: Synchronizing instruments by means of an externally applied reference signal having 10 MHz

Settings:

- Source: "External"
- External Reference Frequency: "10 MHz"

Set the additionally provided parameters, as for example the synchronization bandwidth according to the requirements of the application.

- External $f_{\text{ref}} = 5/10 \text{ MHz}$ (5/10 MHz REF OUT)
If you have an external reference signal with 5 or 10 MHz, you can directly pass it to the output. The signal quality remains the same.

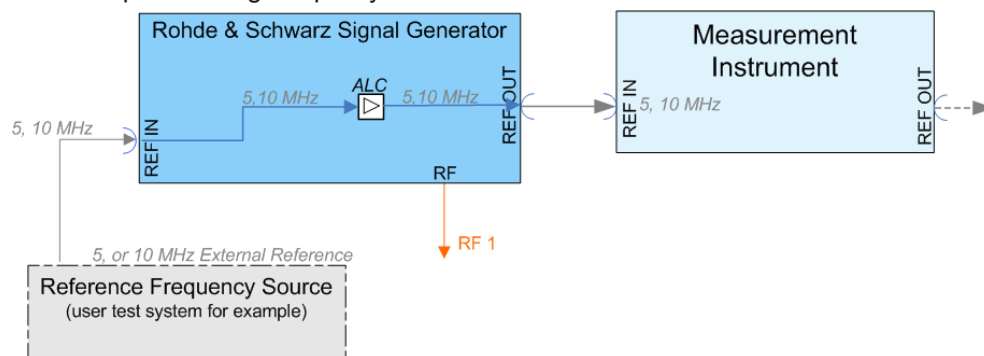

Figure 5-3: Synchronizing a subsequent instrument an externally applied reference frequency of 5 or 10 MHz

Settings:

- Source: "External"
- External Reference Frequency: "5 or 10 MHz"

Input and output connectors of the reference frequency

The appropriate connectors are located at the rear panel, see "REF IN" on page 24 and "REF OUT" on page 24.

5.3.4.1 Reference Oscillator Settings

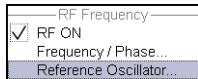

To access the settings dialog for configuring the reference signal, perform one of the following:

- In the block diagram, select "RF > config... > RF Frequency > Reference Oscillator"
- Press the MENU key and select "RF > RF Frequency > Reference Oscillator"
- Press the SETUP key and select "Setup > System > Reference Oscillator"

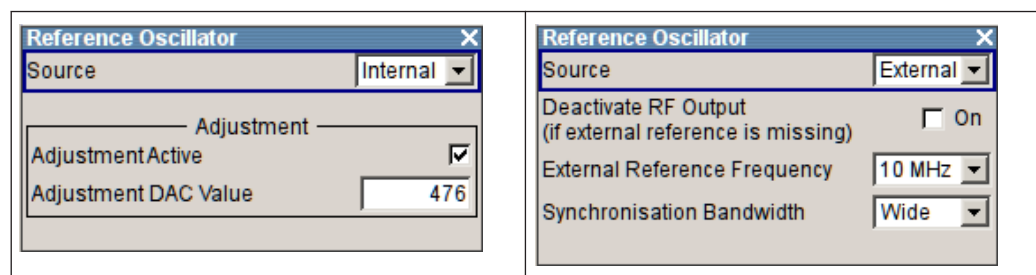

In the "Reference Oscillator Settings" dialog, you can select the signal source and frequency to be used as the reference frequency, and determine a user-defined adjustment value.

The remote commands required to define the reference oscillator settings are described in [Chapter 7.13.14, "SOURce:ROSCillator Subsystem"](#), on page 405.

Source

Selects the source of the reference frequency.

See [Chapter 5.3.4, "Reference Oscillator"](#), on page 141, which provides an overview of the different test scenarios for configuring the reference frequency.

"Internal" Uses the internal 10 MHz reference signal, either with the calibrated or a user-defined adjustment value.

"External" Uses an external reference signal.
The frequency of the external reference signal must be selected under "[External Reference Frequency](#)" on page 144.

Remote command:

[\[:SOURce\]:ROSCillator:SOURce](#) on page 407

Deactivate RF Output (if external reference is missing)

Turns the RF output off when the external reference signal is selected, but no signal is supplied.

This function prevents that no improper RF signal due to the missing external reference signal is used for measurements. A message indicates that the external signal is missing and the RF output is deactivated.

This setting is not affected by a reset.

Remote command:

[\[:SOURce\]:ROSCillator:EXTernal:RFOFf\[:STATe\]](#) on page 406

External Reference Frequency

Determines the frequency of the external reference signal.

You can select an external reference signal having a frequency of 5 MHz or 10 MHz.

Note: The installed hardware determines the available settings. Use the [Hardware Config](#) dialog to check the hardware the instrument is equipped with.

For information on the required hardware revision, refer to the release notes.

Remote command:

[\[:SOURce\]:ROSCillator:EXTernal:FREQuency](#) on page 405

Synchronization Bandwidth

Selects the synchronization bandwidth for an external reference signal.

"Narrow" Synchronization bandwidth is 50 Hz.

"Wide" The synchronization bandwidth is approximately 350 Hz.
This mode is useful for very precise reference sources of high spectral purity.

Remote command:

[\[:SOURce\]:ROSCillator:EXTernal:SBANdwidth](#) on page 406

Adjustment Active

Selects the adjustment mode.

"OFF" Uses the calibrated internal reference frequency.

"ON" Allows you to apply a deviation to the internal reference frequency, according to your requirements. To enter the value, use [Adjustment DAC Value](#).

Remote command:

[\[:SOURce\]:ROSCillator\[:INTernal\]:ADJust\[:STATe\]](#) on page 407

Adjustment DAC Value

Sets a user-defined deviation for the internal reference frequency. This value takes effect when it is activated with [Adjustment Active](#). "0" represents the calibrated state. The setting range depends on the reference oscillator type and its factory calibration value.

Note: A factory preset resets this setting to the calibration value of the instrument.

Remote command:

[\[:SOURce\]:ROSCillator\[:INTernal\]:ADJust:VALue](#) on page 406

5.3.5 RF Level

5.3.5.1 Overview of RF Level



Message "Level overrange/underrange"

If this message appears in the status line, the set level ("Level") is out of range (see data sheet).

In this case, the signal level at the output can deviate from the set value.

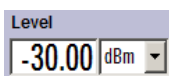

The value of the RF level is displayed in the level field in the header of the display ("Level"). This field provides the direct input of the RF level value. Alternatively, you can enter the level in the "Level/EMF/..." dialog.

Note that the displayed RF level in the header, and the RF output level, set in the "Level/EMF" dialog can be different, as explained in the following section.

RF level vs. RF output level

If you are working with a downstream instrument, e.g. an attenuator or amplifier, you can enter the related parameter value in the level settings dialog ("Offset").

The generator includes these parameters and displays the result in the "Level" field in the status bar, as if the downstream instrument and the generator were one unit. This displayed level value corresponds to the value at the RF output of the downstream instrument. However, the level provided at the RF output of the signal generator corresponds to the level value set in the "Level/EMF/..." dialog.

The instrument activates the "Level Offset" icon in the status bar, when a level offset is set.

The correlation is as follows:

"Level" (in header) = "RF output level" (Level in menu) + "Level offset" (Offset in menu)

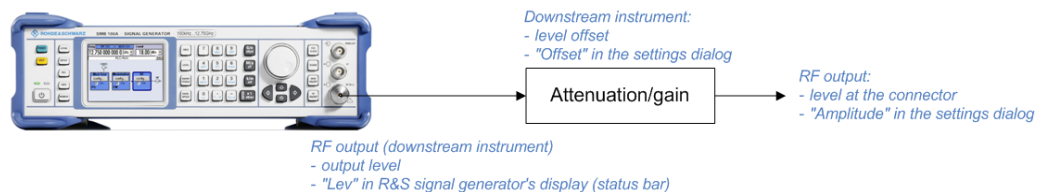

The RF output is protected against overloading by an external signal applied to the RF output (see [Chapter 5.3.5.7, "Reverse Power Protection"](#), on page 165).

Setting the RF level

To change the RF level, press the LEVEL key and enter the desired level. Changes to the RF level have an immediate effect (without confirmation with the Enter key) on the output signal.

RF Level

Enters the RF level, considering the level offset (see ["RF level vs. RF output level"](#) on page 145).

dBm, dB μ V, mV and μ V can be used as the level units. The four unit keys are labeled with these units.

Note: The SCPI command sets the level of the "Level" display, i.e. an entered level offset is considered in the level value.

Remote command:

`[:SOURce<hw>] :POWer [:LEVel] [:IMMediate] [:AMPLitude]` on page 379

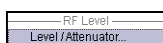
5.3.5.2 RF Level Dialog

Access:

- ▶ Select "RF > config... > RF Level > Level/Attenuator".

The screenshot shows the "RF Level / EMF" dialog box with the following settings:

- Level Settings:**
 - Mode: Normal
 - Amplitude: -30.00 dBm
 - Limit: 30.00 dBm
 - Offset: 0.00 dB
 - Ignore Level Range Warnings: On
- Attenuator Settings:**
 - Mode: Auto
 - Fixed Range (PFP) In: -49.65 ... -29.65 dBm
 - RF OFF Mode: Full Attenuation
- User Variation:**
 - Variation Active: Off
 - Variation Step: 1.00 dB
- Power-On / EMF Settings:**
 - Power-On State: RF Off
 - Display Level as Voltage of EMF: Off
- Ext Level Adjustment:**
 - Adjustment Data: Factory

The offset-free level, level offset and level limit are set in the top section of the dialog. The attenuator mode is set in the "Attenuator Settings" section.

In section "User Variation", you can determine the step size for adjusting the level with the rotary knob (with "Variation Active On").

The power-on behavior of the instrument and the level display in the display header are set in the "Power-On / EMF Settings" section (see [Chapter 5.3.5.3, "Power-On/EMF Settings"](#), on page 151).

The remote commands required to define the settings are described in [Chapter 7.13.12, "SOURce:POWer Subsystem"](#), on page 376.

Level Settings

The offset-free level, attenuation mode, level offset and level limit are set in the top section of the dialog.

If you have the instrument equipped with a harmonic filter, you can also configure the filter.

RF Mode

Selects the level mode for signal output.

This function allows you, to optimize the RF output signal for applications, where improved harmonic suppression or a low Signal-to-Noise ratio is required.

Note: The modes "Low Distortion" and "Low Noise", for improving harmonic suppression or the S/N ratio require that an attenuator is fitted.

"Normal" The generator provides an RF output signal with high signal to noise ratio as well as low distortion, according to the data sheet.

"LOW Noise" This setting forces the generator to optimize the signal to noise ratio.

"LOW Distortion" The generator reduces distortion (harmonics) of the RF signal.

Remote command:

`[:SOURce<hw>] :POWER:LMODE` on page 381

Amplitude

Sets the RF level of the RF output connector.

The level entered and displayed here corresponds to the level at the RF output, that means any offset entry is not considered.

Note: Suppressed values in the status bar

For security concerns or certain operating modes you can hide the frequency and level display in the status bar.

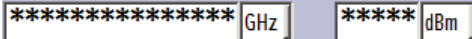
- 

The display has been disabled for security reasons, see [Annotation Frequency](#) and [Annotation Amplitude](#).

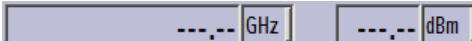
- 

The display is disabled when list mode is running, see ["State - List Mode"](#) on page 189.

Remote command:

`[:SOURce<hw>] :POWER:POWER` on page 383

Note: The SCPI command `[:SOURce<hw>] :POWER[:LEVel] [:IMMediate] [:AMPLitude]` sets the level of the "Level" display, that is the level containing offset.

Limit - RF Level

Sets an upper limit for the RF output power.

You can use it to protect your DUT from damage due to high input power. If you enter an RF level above this value, the instrument limits the output power to this specified value, and generates a warning message.

However, the level indication in the status bar is not affected.

Note: The limit value is always effective, regardless of whether you work with "NRP-Z Power Control" or not.

The value is not affected by an instrument preset (PRESET key), *RST and the "Save/Recall" function. It is influenced only by the [Factory Preset](#) and the factory value is equal to maximum level.

Remote command:

`[:SOURce<hw>] :POWer:LIMit [:AMPLitude]` on page 380

Offset (Level)

Sets the level offset relative to the RF level.

The level offset of a downstream instrument (for example an attenuator or amplifier) is entered.

The entry does not change the value of the RF level at the RF output. It only changes the RF level displayed in the display header. The value of the RF level in the header corresponds to the level at the output of the downstream instrument.

Remote command:

`[:SOURce<hw>] :POWer[:LEVel] [:IMMediate] :OFFSet` on page 379

Ignore Level Range Warnings

Suppresses warnings the instrument generates when either the level, or the PEP value are out of range. This function prevents automated measurements from being stopped due to a level warning.

The following warnings are suppressed in both, the history and in the error queue:

- Level overrange / level underrange
- PEP value greater than defined upper bound / PEP value less than defined lower bound (fix range)

Remote command:

`[:SOURce] :POWer:WIGNore` on page 381

Low Harmonic Filter Settings

In 20 GHz or 40 GHz instruments (option R&S SMB-B120(L) /-B140(L)), you can install a low harmonic filter (option R&S SMB-B25 /-B26), to improve the harmonic performance.

See the website <http://www.rohde-schwarz.com/product/smb100a.html> or the data-sheet for more information on the options available according to the features of your instrument.

For a fitted low harmonic filter, you can define its operating mode in section "Low Harmonic Filter" of the "RF Level / EMF" dialog. Otherwise, the section is hidden.

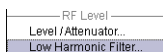

- To access the filter settings, select "RF > Config > RF Level > Low Harmonic Filter".

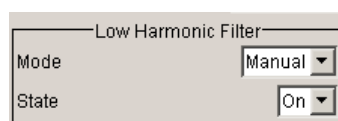

Mode

Selects between automatic or manual switching of the filter.

"Auto" The filter switches automatically on and off, according to the given operating conditions. It is active within a certain frequency and level range and automatically turns off, if the frequency falls below the lower limit, or the level exceeds the upper limit. The corresponding limit values are given in the data sheet.

Note: The **State** field shows the current state of the filter.

"Manual" In this mode, you can switch the filter individually.

Remote command:

`:OUTPut<hw>:FILTer:AUTO` on page 313

State

Switches the filter in manual mode.

Note: If you work in the "Auto" **Mode**, this parameter shows the current state of the filter. If you then change the state, the operation mode automatically turns to manual operation.

Remote command:

`:OUTPut<hw>:FILTer[:LPASs]:STAtE` on page 313

Attenuator Settings

The R&S SMB can be configured to provide level settings without interruption. It is possible for instruments with or without step attenuator. The attenuator mode is set in the "Attenuator Settings" section of the "RF level / EMF" dialog.

Attenuator Mode

Sets the attenuator mode at the RF output.

"Auto" Standard mode.

"Fixed" When this operating mode is switched on, the attenuator, relays and amplifier stages are fixed in their current positions to provide level settings without interruption. The resulting variation range is defined and displayed under "Attenuator Fixed Range".

Note: The function is effective when automatic level control is activated ("ALC State = On").

If the normal variation range is overranged or underranged, level errors increase considerably and the warning "Level under/over-range" appears in the info line. The spectral purity of the output signal decreases with high attenuation.

Remote command:

`:OUTPut<hw>:AMODE` on page 313

Fixed Range (PEP) In

Displays the level range in which the level is set without interruption for the "Attenuator Mode fixed" setting.

Remote command:

`:OUTPut<hw>:AFIXed:RANGe:UPPer?` on page 312

`:OUTPut<hw>:AFIXed:RANGe:LOWer?` on page 312

RF OFF Mode

Selects the attenuator mode, when the RF signal is switched off.

The setting of the RF OFF mode is not affected by an instrument preset (PRESET key), *RST and the "Save/Recall" function. This parameter is influenced only by the [Factory Preset](#).

"Unchanged" Freezes the setting of the attenuator when RF is switched off. The attenuator is only activated when RF is switched on. This setting is recommended if a constant VSWR (**V**oltage **S**tanding **W**ave **R**atio) is required. Furthermore, on instruments equipped with a mechanical attenuator, it provides fast and wear-free operation.

"Full Attenuation" Sets attenuation to maximum when the RF signal is switched off. This setting is recommended for applications that require a high level of noise suppression.

Remote command:

`[:SOURce<hw>] :POWer:ATTenuation:RFOff:MODE` on page 378

User Variation

If the level is set using the rotary knob, the step width is defined in the "User Variation" section.

Variation Active

Activates the user-defined step width used when varying the level value with the rotary knob.

"ON" The level value set with the rotary knob is varied using the user-defined step width which is entered under "Variation Step".

"OFF" The level value set with the rotary knob is varied in steps of one unit at the cursor position (standard operating mode).

Remote command:

`[:SOURce<hw>] :POWer:STEP:MODE` on page 386

Variation Step

Sets the user-defined step width for entering the RF level using the rotary knob. Level variation with this step width must also be activated with "Variation Active".

Remote command:

`[:SOURce<hw>] :POWer:STEP [:INCRe ment]` on page 386

External Level Adjustment

The external level adjustment provides information about the data that has been used for calibrating the RF level.

By default the instrument uses correction data obtained in the factory before delivery. In exceptional cases, you can determine the calibration values with an R&S NRP power sensor, and use these values for the external level correction. This feature is a protected function (see Service Manual, chapter 2, "Adjustment").

Adjustment Data

Indicates what data has been used for level calibration.

Remote command:

`:CALibration<hw>:LEVel:EXTern:DATA` on page 287

5.3.5.3 Power-On/EMF Settings

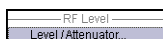

The power-on behavior of the R&S SMB and the level display in the display header are set in the "Power-On / EMF Settings" section of the "RF Level/EMF" dialog.

To open the "RF Level/EMF" dialog, select "RF > Configure > EMF" or use the MENU key under "RF".

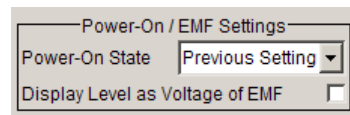

Power-On State - RF Signal

Selects the state which the RF output is to assume after the instrument is switched on.

"RF Off" The output is deactivated when the instrument is switched on.

"Previous Setting" When the instrument is switched on, the output assumes the same state as it had when the instrument was switched off.

Remote command:

`:OUTPut<hw>[:STATe]:PON` on page 315

Display Level as Voltage of EMF - RF Level

Activates display of the signal level as voltage of the EMF (no-load voltage). If this setting is deactivated, the level is displayed as a voltage over a 50 Ohm load.

Note: This setting is not affected by an instrument preset (PRESET key), *RST or the "Save/Recall" function. Only the [Chapter 5.2.3.20, "Factory Preset"](#), on page 120 resets the setting.

Remote command:

`[:SOURce<hw>]:POWer:EMF:STATe` on page 378

5.3.5.4 Automatic Level Control - ALC

Your signal generator is equipped with an automatic level control unit to obtain best RF level accuracy.

Automatic Level Control (ALC) is an adaptive control system to stabilize the RF output level. It continuously monitors the current level and adjusts it to keep a steady state over temperature and time.



ALC is active in almost all applications by default. However, the **Pulse Modulation** mode excludes ALC, as the control loop would detect incorrect values and result in level deviations.

Also note that ALC may detect incorrect values in **multi-transmitter** test setups. If multiple generators are coupled, reverse power may affect the ALC readings. Based on incorrect values, ALC would have an impact on the signal to intermodulation ratio.

ALC States

The following description basically explains the ALC states and their principle of operation. In particular **ALC OFF (Sample & Hold)** gives an overview on the function in terms of the equipment of the generator.

The R&S SMB offers the ALC states:

- **AUTO**
automatically adjusts the output level to the operating conditions.
- **On**
enables ALC permanently, regardless of the currently selected mode.
- **Off**
deactivates ALC.
The instrument switches to **Sample & Hold (S&H)** state, which still allows to maintain a constant output level.

The following section explains the functionality of "Sample & Hold", to provide an overview and to indicate what is to be considered. "On" and "Auto" require no additional explanation. Furthermore, find the ALC state settings described in detail in [State - ALC](#).

ALC OFF (Sample & Hold)

In "S&H" mode, the signal generator switches for a short period of time into CW mode and activates ALC. ALC adjusts the level to the set value and the generator holds the value (freeze). Then, the generator switches ALC off again and back to the operating mode.

RF output behavior during Sample & Hold depends on the configuration of your instrument. Instruments equipped with...:

- an **electronic step attenuator**
The level is decreased by 30 dB.
- a **mechanical step attenuator**
By default, the mechanical step attenuator is not switched during S&H cycles to optimize the settling time. The instrument provides the output power for 3 ... 5 ms. However, you can affect the attenuation at the output by the setting "RF during Power Search" to "Minimum", see [RF During Power Search - ALC](#). Then the generator decreases the level by 30 dB with the mechanical attenuator. Note that this may take a certain period of time.
High frequency instruments, such as the R&S SMB with one of the high frequency options R&S SMB-B120 or R&S SMB-B140, are equipped with a **mechanical step attenuator**.
- **no step attenuator**

The signal generator outputs the set level for 3 to 5 ms after level or frequency setting during a Sample & hold measurement.

Instruments equipped with one of the options R&S SMB-B112L, R&S SMB-B120L or R&S SMB-B140L come without step attenuator.

The level control status is permanently displayed as a status message in the info line.

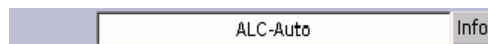

Automatic Level Control Settings

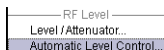

To open the "Automatic Level Control" dialog, select "RF" > "Configure" > "Automatic Level Control" or use the MENU key under "RF".

The combined dialog "ALC / UCOR" is divided into the several sections and provides access to the "Automatic Level Control" settings and to function "User Correction", see [Chapter 5.3.5.6, "User Correction"](#), on page 158).

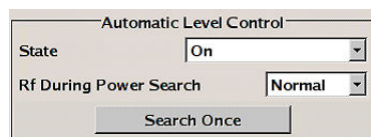

State - ALC

Activates/deactivates internal level control.

"Auto" The instrument selects the most appropriate ALC mode automatically.

ALC is on in most operating conditions. Default state.

"On" Activates ALC, regardless of the operating conditions.

"Off (Sample & Hold)"

Deactivates internal level control.

Sample & hold closes the level control loop at every frequency and level change for a short period of time. The level control voltage is sampled and then clamped.

Remote command:

`[:SOURce<hw>] :POWer:ALC [:STATe]` on page 377

RF During Power Search - ALC

Activates the mode for the mechanical step attenuator and for output during ALC power search.

"Normal" The RF output is active during power search.

"Minimum" The RF output is inactive during power search.

Remote command:

`:OUTPut<hw>:ALC:SEARch:MODE` on page 312

Search Once - ALC

Forces the generator to execute level adjustment once, although the "Sample & Hold" mode is active.

Remote command:

[:SOURce<hw>] :POWer:ALC:SONCe on page 377

5.3.5.5 NRP-Z Level Control

With the NRP-Z Level Control function, you can achieve a very stable and accurate RF power supplied to your DUT. With the aid of a downstream control circuit, a CLPC (Closed Loop Power Control), you can detect frequency response characteristics of the used components, such as losses due to cables, modules or components like power amplifiers, and compensate these effects accordingly.

Example: How to set up a closed loop power control

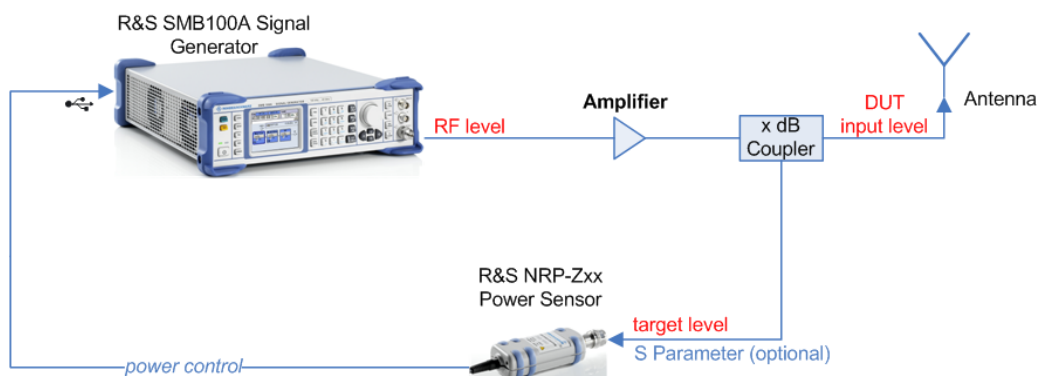

Figure 5-4: Example of a test setup with NRP-Z Level Control

As shown in the example, the sensor measures a proportional power in defined time intervals, derived from a coupler. It considers optionally given S-parameters and returns the results to the generator. The signal generator compares the measured level with the set value and adjusts its output level accordingly.

This allows you to control the external signal level continuously and reliably reach a constant input level at the DUT in real time.



Impact of the NRP-Z Level Control and the Operating Modes

Since the frequency and level of the RF output signal are continuously adjusted during "NRP-Z Level Control", this operating mode interferes those with varying frequency and level values.

The reason is, that the generator regularly transmits the output frequency to the connected R&S NRP-Zxx power sensor, which in turn requests the signal generator to adjust the output level according to its measurement. In contrast to this real time control loop, for example the list operating mode already generates the RF output signal on previously optimized frequency and level value pairs. In this case, the "NRP-Z Level Control" as a second control loop would impact the already determined RF signal values and also considerably slow down the measurement. Similar impacts occur in sweep mode, and also the "NRP-Z Power Viewer" and "NRP-Z Level Control" affect each other's functionality.

Hence, the operating modes exclude each other as follows:

- "NRP-Z Level Control" automatically disables [NRP-Z Power Viewer](#), and vice versa.
- Activating the RF frequency sweep, RF level sweep or the list mode instantly deactivates a running "NRP-Z Level Control".
- A running list or RF sweep mode blocks "NRP-Z Level Control". It can not be activated.

Also keep in mind that modulated signals may differ from CW signals regarding mean power and peak power. This affects the operation of "NRP-Z Level Control".

NRP-Z Level Control Settings

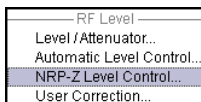

- ▶ To access the dialog for configuring the level control settings, perform one of the following:

- Select "RF > config... > RF Level > NRP-Z Level Control".
- Press the MENU key and select "RF > RF Level > NRP-Z Level Control".

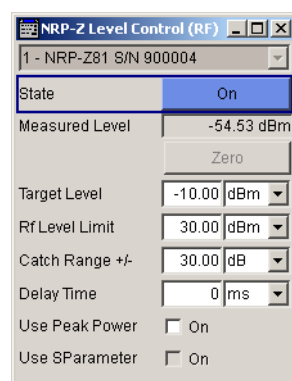

The dialog contains all parameters for configuring the settings for level control test setup.

The remote commands required to define these settings are described in [Chapter 7.13.12, "SOURce:POWer Subsystem"](#), on page 376

Sensor

Selects the R&S NRP-Z power sensor for power control.

Note: In remote control, the sensors are set up using the `SENSe` commands. The remote measurement is triggered by the `READ` query which also provides the measurement results.

The software version of the connected power sensor can be retrieved by means of the remote control command `:SENS:POW:TYPE?`.

Use the "Setup >" [Chapter 5.2.3.5, "NRP-Z Info/Update"](#), on page 97 dialog to update the sensor software.

Remote command:

`[:SOURce<hw>] :POWer:SPC:SElect` on page 384

State

Activates power control using the selected sensor.

The control loop periodically adjusts the generator output. After switching off, the running loop is completed.

Remote command:

`[:SOURce<hw>] :POWer:SPC:STATe` on page 385

Measured Level

Indicates the current reading of the sensor.

Zero - Power Sensors

Activates the auto zero function.

Zeroing calibrates the external power sensor by adjusting its reading at zero signal power. For this purpose, the RF power source must be switched off or disconnected from the sensor. If a Rohde & Schwarz power sensor receives an input power during the zeroing process, it aborts zeroing and generates an error message. Zeroing takes a few seconds, depending on the sensor model. Refer to the documentation of your power sensor for more information.

Tips for zeroing

When to perform zeroing:

- During warm up after switching on or connecting the instrument
- After a substantial change of the ambient temperature
- After fastening the power sensor module to an RF connector at high temperature
- After several hours of operation
- When low-power signals are to be measured, e.g. less than 10 dB above the lower measurement limit.
- Switch off the RF power source for zeroing, but do not disconnect it from the power sensor. This proceeding keeps the thermal equilibrium, and the zeroing process also compensates the noise that superimposes the measured signal (e.g. from a broadband amplifier).

Remote command:

`:SENSe<ch> [:POWer] :ZERO` on page 324

Target Level

Specifies the nominal level expected at the input of the sensor. The signal generator adjusts the output power accordingly, in order to meet the target value at the sensor input, and thus the power required at the DUT.

Remote command:

`[:SOURce<hw>] :POWer:SPC:TARGet` on page 385

Limit - RF Level

Sets an upper limit for the RF output power.

You can use it to protect your DUT from damage due to high input power. If you enter an RF level above this value, the instrument limits the output power to this specified value, and generates a warning message.

However, the level indication in the status bar is not affected.

Note: The limit value is always effective, regardless of whether you work with "NRP-Z Power Control" or not.

The value is not affected by an instrument preset (PRESET key), *RST and the "Save/Recall" function. It is influenced only by the [Factory Preset](#) and the factory value is equal to maximum level.

Remote command:

`[:SOURce<hw>] :POWer:LIMit [:AMPLitude]` on page 380

Catch Range +/-

Sets the capture range of the control system.

Within the range:

Target Level +/- Catch Range

the power control locks and tries to achieve the target level. Readings outside the range are not considered.

Remote command:

`[:SOURce<hw>] :POWer:SPC:CRANge` on page 383

Delay Time

Defines a waiting period between the level adjustment of the generator and the next measurement of the power sensor.

With this parameter, you compensate any dead times in the controlled system.

Remote command:

`[:SOURce<hw>] :POWer:SPC:DELay` on page 384

Use Peak Power

Activates control by means of the peak power values, provided the power sensor supports this function. Otherwise, the dialog does not show this parameter.

Remote command:

`[:SOURce<hw>] :POWer:SPC:PEAK` on page 384

Use SParameter - Power Sensors

Activates the use of the S-Parameter correction data of the connected power sensor. For sensors with attenuator this checkbox is automatically checked.

Refer to the manual of the connected R&S NRP-Zxx power sensor for a description on how to use the SParameter table.

Remote command:

`:SENSe<ch>[:POWer]:CORRection:SPDeVice:STATe` on page 317

5.3.5.6 User Correction

The "User Correction" function is used to create and activate lists in which level correction values predefined by the user are freely assigned to RF frequencies. Correction is performed by the user-defined table values being added to the output level for the respective RF frequency.

With frequencies which are not contained in the list, the level correction is determined by interpolation of the closest correction values.

The lists are created in the "List Editor". Each list is stored in its own file with the predefined file extension `*.ucO`. The name of the User Correction file can be freely selected. The files are loaded from the "Lists..." file manager. Externally created tables with pairs of frequency and level values can be converted into User Correction files using the import function. The external files must have the file extension `*.txt` or `*.csv`. These file formats are provided e.g. by the Microsoft Excel program. The separators for table columns and for decimal floating-point numerals can be set. In addition, internally created User Correction data can be exported into ASCII files using the export function.

The amplitude can also be linearized automatically by means of an R&S NRP power sensor connected to one of the generator output signals. With the aid of the "Fill with Sensor" function, a table with correction values for external test assemblies can be automatically determined, e.g. for compensating the frequency response of cables. The User Correction list with the correction values acquired by the sensor is generated in the "Edit User Correction List" menu. The correction values can be acquired any time irrespective of the modulation settings of the generator.

If user correction is activated, the "UCOR" display (User Correction) is shown in the header together with the "Level" display. The RF output level is the sum of both values.

"Level" + "UCOR" = Output level

If activated, user correction is effective in all operating modes.

User Correction Menu

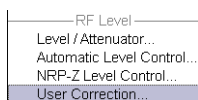

To open the "User Correction" menu, select "RF > Configure > User Correction" or use the MENU key under "RF".

The combined menu "ALC/UCOR" is divided into the several sections.

User Correction Settings

The "User Correction" settings are set in the most lower section of the combined dialog; this section is used to activate/deactivate user correction, and to create, select and activate the lists.

The upper section provides access to the automatic level control settings, see [Chapter 5.3.5.4, "Automatic Level Control - ALC"](#), on page 151.

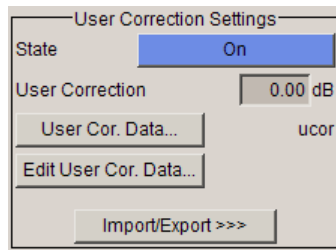

State - User Correction

Activates/deactivates user correction.

The "UCOR" status message appears in the frequency and level display.

Remote command:

`[:SOURce<hw>] :CORRection [:STATe]` on page 336

User Correction Value - User Correction

Indicates the current value for level correction.

Remote command:

`[:SOURce<hw>] :CORRection:VALue?` on page 336

User Cor. Data - User Correction

Calls the "File Select" menu for selecting and creating a list or the "File Manager".

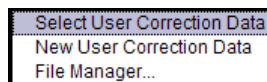

Remote command:

`[:SOURce] :CORRection:CSET:CATalog?` on page 329

`[:SOURce<hw>] :CORRection:CSET [:SElect]` on page 335

`[:SOURce] :CORRection:CSET:DELeTe` on page 331

Edit User Cor. Data - User Correction

Calls the editor for editing the selected user correction list.

A list consists of any number of frequency/level value pairs. The currently selected list is displayed.

Each list is saved as a separate file with extension `*.uco`. The file name and the directory to which the file is saved are user-selectable.

Note: Save list only after filling both columns (frequency and level), otherwise the entries are lost.

	Frequency/Hz	Power/dB
6	5 300 000.00	5.42
7	6 300 000.00	4.73
8	7 300 000.00	4.15
9	8 300 000.00	3.72
10	9 300 000.00	3.28

"Frequency / Hz" Enters the frequency to which the level correction value applies.

Note: The "Fill..." function allows to automatically enter any number of frequencies with freely selectable range and increment. Using the "Fill With Sensor" function of the "Edit" sub menu requires only the entry of the frequency values. The level values are automatically acquired by the connected power sensor.

"Power/dB" Enters the level correction value to which the specified frequency applies. The values can be entered manually or automatically with the "Fill With Sensor" function (available in the "Edit" sub menu).

"Goto" Selects row for editing.

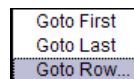

If Goto row is selected, a window opens for entering the requested row.

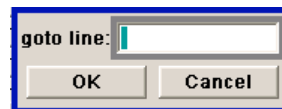

"Edit" Calls a selection of possible actions described below.

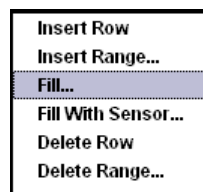

"Insert Row" Insert a new row before the marked row.

"Insert Range" Insert new rows before the marked row. The number of rows to be inserted can be defined in an entry window.

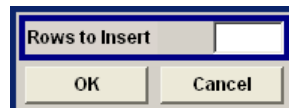

"Fill..." Opens a sub menu for defining a set of list values to be automatically entered in the ucor list (see ["Filling the Correction List automatically"](#) on page 162).

- "Fill With Sensor" Calls the menu to activate the filling of the user correction list with level values acquired by the selected power sensor (see ["Filling the Correction List with Power Sensor Measurement Data"](#) on page 164).
- "Delete Row" Deletes the marked row.
- "Delete Range..." Allows to delete any number of rows starting with the marked row. The number of rows to be deleted can be defined in an entry window.

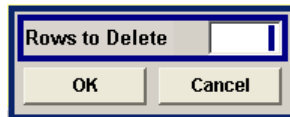

"Save" The list is saved under its current name.

Remote command:

- [\[:SOURce<hw>\]:CORRection:CSET\[:SElect\]](#) on page 335
- [\[:SOURce<hw>\]:CORRection:CSET:DATA:FREQuency](#) on page 330
- [\[:SOURce<hw>\]:CORRection:CSET:DATA:POWer](#) on page 330

Import/Export

User correction list can be imported from externally created files or exported into text or CSV-files. The import/export settings are available after clicking the "Import/Export" button.

Import/Export >>>

Expands the menu with the area for import and export of user correction files.

Externally edited Excel tables with any number of frequency/level value pairs can be imported as text or CSV-files and used for user correction.

Conversely, you can also export internally created user correction lists as text or CSV-files.

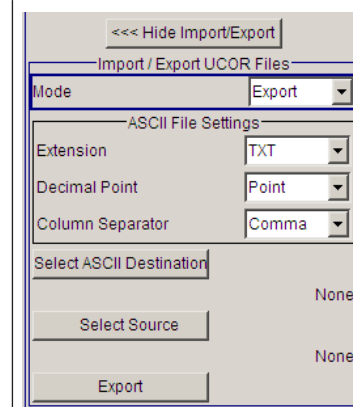
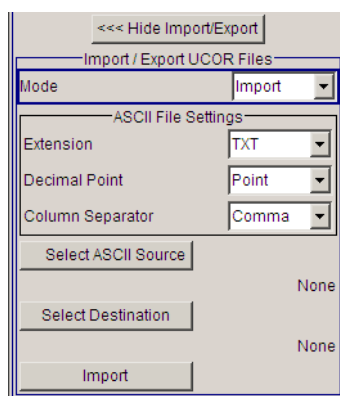

Mode - User Correction

Selects if user correction lists should be imported or exported. The settings offered depend on the selected mode.

Remote command:

- [\[:SOURce<hw>\]:CORRection:DEXChange:MODE](#) on page 334

Extension - User Correction

Selects the file extension of the ASCII file to be imported or exported. Selection "TXT" (text file) or "CSV" (Excel file) is available.

Remote command:

`[:SOURce<hw>] :CORRection:DEXChange:AFIle:EXTension` on page 332

Decimal Point - User Correction

Selects the decimal separator used in the ASCII data between '.' (decimal point) and ',' (comma) with floating-point numerals.

Remote command:

`[:SOURce<hw>] :CORRection:DEXChange:AFIle:SEParator:DECimal`
on page 333

Column Separator- User Correction

Selects the separator between the frequency and level column of the ASCII table the user correction list is exported to or imported from.

Remote command:

`[:SOURce<hw>] :CORRection:DEXChange:AFIle:SEParator:COLumn`
on page 333

Select ASCII Source / Destination - User Correction

Calls the "File Manager" for selecting the ASCII file to be imported into a user correction list (source) or the ASCII file the user correction list is exported (destination) in.

Remote command:

`[:SOURce<hw>] :CORRection:DEXChange:AFIle:SElect` on page 332

Destination / Source - User Correction

Calls the "File Manager" for selecting the user correction list to be exported (source) into an ASCII file or the destination for the ASCII file to be imported (destination) in.

Remote command:

`[:SOURce<hw>] :CORRection:DEXChange:SElect` on page 335

Import / Export - User Correction

Starts the export or import of the selected file.

When import is selected, the ASCII file is imported as user correction list.

When export is selected, the user correction list is exported into the selected ASCII file.

Remote command:

`[:SOURce<hw>] :CORRection:DEXChange:EXECute` on page 334

Filling the Correction List automatically

The "Fill Table" menu enables you to automatically set the level correction values.

The start line and the number of rows to be filled are defined under "From" and "Range."

The column to be filled is selected under "Select column to fill". Depending on the selection here, the default for start, end, and increment value are set. As the settings are interdependent, a change of one parameter may result in the automatic change of one or more of the other parameters. The filling of the column with the selected value settings is started with button "Fill".



The correction list entries are only computed when the "Fill" button is pressed.

From

Sets the start value of the index range.

Remote command:

n.a.

Range

Sets the range for filling the table.

Remote command:

n.a.

Select column to fill

Selects either the frequency or the level column to be filled with the value defined below.

Remote command:

n.a.

Start value

Sets the start value for the frequency or the level entries.

Remote command:

n.a.

End value

Displays the end value for the frequency or the level entries.

Remote command:

n.a.

Increment value

Sets the increment for the frequency or the level entries.

Remote command:

n.a.

Fill

Fills the selected column in the set range with values, starting with the start value and using the set increment.

Remote command:

n.a.

Filling the Correction List with Power Sensor Measurement Data

The level correction values for the user correction list can be acquired by means of R&S NRP power sensors. The R&S NRP sensors are connected to either the SENSOR connector or to one of the USB interfaces. Configuration of the connection is performed in the "Power Sensor" menu (see [Chapter 5.3.6.1, "NRP-Z Power Viewer"](#), on page 166). The filling of the user correction list with measurement data is performed in the ucor list editor (see ["Edit User Cor. Data - User Correction"](#) on page 159).

In the editor, the frequencies for which the correction values are to be acquired are entered in the frequency column (either manually or by means of the "Fill..." menu).



Do not save the list at this point, because the frequency entries are lost as long as there are no entries for the level column also. In the following these entries are automatically acquired by the connected power sensor.

All level correction values for the given frequency values are measured using the Power Sensor and automatically filled in the selected list after the "Execute" button is pressed. The list is automatically stored and recalled again after filling.

Fill User Correction Data with Sensor Settings

The "Fill with Sensor" button of the "Edit User Correction Data" menu opens the associated menu.

This dialog describes all parameters for filling a table automatically with sensor readings.



To select the sensor and determine its parameters, refer to [Chapter 5.3.6.1, "NRP-Z Power Viewer"](#), on page 166.

To fill the table, press the "Execute" button.

Fill User Correction Data with Sensor

Enables you to fill the table with correction data acquired by a connected power sensor from Rohde & Schwarz.

"Sensor"	Displays connected sensors for selection.
"List To Fill"	Indicates the used list file.
"Include Zeroing"	Performs a zeroing procedure before acquiring the user correction data to improve precision. Since during zeroing no signal may be applied to the sensor, RF is temporarily switched off at the generator. When unchecked, the zeroing procedure is skipped. The RF signal level might be blanked shortly. This setting is recommended if blanking of RF is undesirable or the absence of power at the sensor can not be guaranteed.
"Execute"	Performs automatic filling of the list, provided a sensor is detected and the user correction list contains at least one frequency value.

Remote command:

`[:SOURce<hw>] :CORRection:ZERoing:STATe` on page 336

`[:SOURce<hw>] :CORRection:CSET:DATA [:SENSor<ch>] [:POWer] :SONCe` on page 331

Used SMB Settings for Measurement

Displays the settings relevant for the measurement.

"RF Source"	Shows the path for which the correction menu settings are made.
"Modulation"	Indicates the modulation state
"Amplitude"	Shows the currently set level.
"Use SParameter"	Indicates whether SParameter correction is used.
"Attenuator Mode"	Displays the selected mode of the attenuator.
"Fixed Range (PEP) In:"	Shows the level range.

Remote command:

n.a.

5.3.5.7 Reverse Power Protection

The reverse power protection prevents against overload by an external signal applied to the RF output of the R&S SMB.



The R&S SMB equipped with frequency options up to 6 GHz includes a reverse power protection as standard. For instruments equipped with frequency option R&S SMB-B112 or R&S SMB-B112L a reverse power protection option R&S SMB-B30 is available. Refer to the data sheet for additional information and the respective option.

The reverse power protection is tripped when the power of the external signal becomes too high. A relay opens and interrupts the internal connection to the RF output. This condition is indicated in the display header by the "OVERLOAD" status message.

Overload

If an "Overload" status message is indicated in the display header, reset the overload protection by pressing the RF ON/OFF key.

The RF input is activated when the overload protection is reset.

Remote command:

`:OUTPut<hw>:PROTection:TRIPped?` on page 314

`:OUTPut<hw>:PROTection:CLEAr` on page 314

`:OUTPut<hw>[:STATe]` on page 314

5.3.6 RF Measurement

5.3.6.1 NRP-Z Power Viewer

The R&S SMB features the power viewer function for measuring or monitoring either the RF output power, or a freely selectable signal source with R&S NRP-Z power sensors.

The instrument can perform up to 4 power measurements simultaneously.

To connect the sensors you have the following options:

- connect the sensor directly at a USB connector
To connect a sensor directly via USB, use one of the appropriate adapter cables R&S NRP-Z3 or R&S NRP-Z4.
- connect the sensor indirectly via USB using the R&S NRP-Z5 USB Sensor Hub.

For the assignment to the available connectors, see [Chapter 2, "Preparing for Use"](#), on page 15.



Using the R&S NRP-Z5 Sensor Hub

The R&S NRP-Z5 USB Sensor Hub (high-speed USB 2.0) can host up to 4 R&S NRP-Z sensors and provides simultaneous internal and external triggering of all connected sensors. You can directly connect the R&S NRP-Z Sensors to the standard NRP sensor connectors of the hub.

The hub is connected to the R&S instrument via USB with the adapter cable R&S NRP-Z4.

See also the R&S website <http://www.rohde-schwarz.com> in section "Power Meters & Voltmeters > R&S NRP-Z Sensors" for information on the sensor hub and the available accessories.

The instrument automatically detects a connected R&S NRP-Z power sensor and indicates it in the "NRP-Z Power Viewer" dialog. Each connected sensor is assigned to one of the four channels, according to the sequence of connection.

For device specific information on the connected sensor see the [Chapter 5.2.3.5, "NRP-Z Info/Update"](#), on page 97 dialog. For information on the scope of your power sensor refer to the manual of your R&S NRP-Zxx power sensor.

A sensor continuously measures the average signal power of the selected source, such as an external signal, or the output signal of the signal generator with the RF level used as reference value. The signal generator shows the result in the [NRP-Z Power Viewer Settings](#) settings dialog, but you can also permanently display the readings in the block diagram.



Further functions of the R&S SMB related to R&S NRP-Z power sensors are:

- Acquisition of level correction data, see [Chapter 5.3.5.6, "User Correction"](#), on page 158.
The acquired level correction data is used to create and activate lists in which level correction values predefined by the user are freely assigned to RF frequencies. Correction is performed by the user-defined table values being added to the output level for the respective RF frequency.
- NRP-Z Level Control, see [Chapter 5.3.5.5, "NRP-Z Level Control"](#), on page 154. Note that "NRP-Z Power Viewer" automatically disables "NRP-Z Level Control", and vice versa.
- The software version of the connected power sensor can be retrieved by means of the remote control command `SENSe<ch>[:POWER]:TYPE?` on page 324. Use the [Chapter 5.2.3.5, "NRP-Z Info/Update"](#), on page 97 dialog to update the sensor software.



"NRP-Z Power Viewer" automatically disables [NRP-Z Level Control](#), and vice versa.

NRP-Z Power Viewer Settings



- ▶ To access the dialog for configuring the RF signal level, perform one of the following:

- Select "RF > config... > RF Measurement > NRP-Z Power Viewer".
- Press the MENU key and select "RF > RF Measurement > NRP-Z Power Viewer".

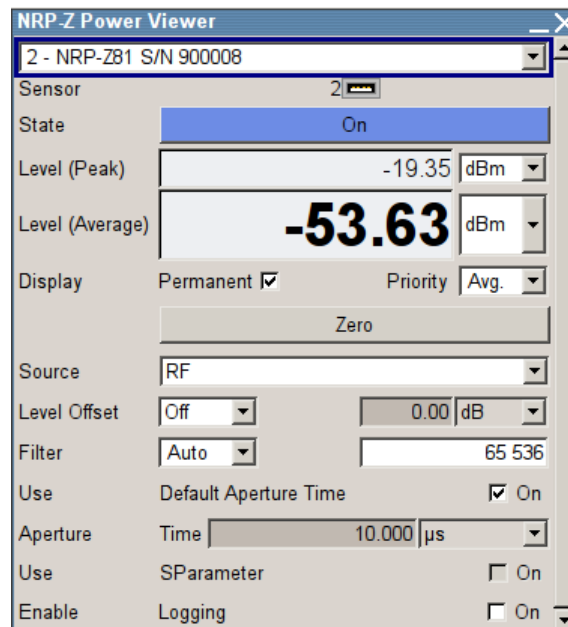

The dialog shows the settings and measurement values of the sensor selected in the field next to the connector symbol. For indicating the parameters of another sensor, switch to the respective sensor in the selection list.



When you connect your power sensor(s) via the R&S NRP-Z5 USB sensor hub, each channel of the hub is firmly assigned to the associated sensor channel in the generator.

The remote commands required to define the settings are described in [Chapter 7.12, "SENSe, READ and INITiate Subsystems"](#), on page 315.

Sensor

Selects the R&S NRP-Z power sensor for display.

In remote control, the sensors are set up using the `SENSe` commands. The remote measurement is triggered by the `READ` query which also provides the measurement results.

The sensor is selected by suffix 1, 2, 3 or 4 in key word `SENSe` or `READ` of the command header.

Suffix 1 denotes the sensor connected at the first USB interface, and suffix 2, 3 and 4 are assigned to further sensors connected via USB. The suffix is identical to the index which is assigned automatically to each sensor upon connection.

Note: The software version of the connected power sensor can be retrieved by means of the remote control command `:SENS:POW:TYPE?`.

Use the "Setup >" [Chapter 5.2.3.5, "NRP-Z Info/Update"](#), on page 97 dialog to update the sensor software.

Remote command:

[SENSe<ch>\[:POWer\]:STATus\[:DEVIce\]? on page 323](#)

Type

Indicates the type and the serial number of the connected R&S NRP-Z power sensor. The sensor type is automatically detected.

Remote command:

[SENSe<ch>\[:POWer\]:TYPE? on page 324](#)

[SENSe<ch>\[:POWer\]:SNUMber? on page 322](#)

State

Activates/deactivates level measurement by the power sensor.

The local state is set with the `INIT` command. Switching the local state off enhances the measurement performance.

In remote control, the sensors are set up using the `SENSe` commands. The remote measurement is triggered by the `READ` query which also provides the measurement results. The state is not influenced by these commands, measurements results can be retrieved with local State on or off.

The sensor is selected by suffix 1, 2, 3 or 4 in key word `SENSe` or `READ` of the command header.

Suffix 1 denotes the sensor connected at the first USB interface, and suffix 2, 3 and 4 are assigned to further sensors connected via USB. The suffix is identical to the index which is assigned automatically to each sensor upon connection.

To query the availability of a sensor at a given connector, use the command

[SENSe<ch>\[:POWer\]:STATus\[:DEVIce\]? on page 323.](#)

Remote command:

[:INITiate<ch>\[:POWer\]:CONTinuous on page 316](#)

Level (Peak)

With certain power sensors only, for example R&S NRP-Z81.

Indicates the measured peak level value with the selected unit.

Remote command:

[:READ<ch>\[:POWer\]? on page 317](#)

Level (Avg.)

Indicates the measured level value with the selected unit.

Remote command:

[:READ<ch>\[:POWer\]? on page 317](#)

Unit

Selects the unit used for result display.

The power sensor provides the measured value in Watt.

In which unit the measured value is indicated is selected here and might be Watt, dBm or dBuV.

Remote command:

`:SENSe<ch>:UNIT[:POWer]` on page 324

Permanent Display State

Activates the permanent indication of the power measurement result in the upper right corner of the block diagram. The instrument shows the type of sensor, the corresponding connector, the measurement source and - if set - the offset.

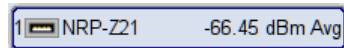

It is possible to switch the permanent display active for several sensors. In this case, the instrument indicates the values of the sensor with the lowest port number in the display.

Remote command:

`:SENSe<ch>[:POWer]:DISPlay:PERManent:STATe` on page 318

Display Priority

Determines whether the instrument displays the measured average or the peak power permanently on the screen.

To select the peak power display, it is required that the R&S NRP-Zxx sensor supports this feature. On power-on or connecting a sensor the average power value is set by default.

To enable the permanent display in the block diagram, select [Permanent Display State](#).

Remote command:

`:SENSe<ch>[:POWer]:DISPlay:PERManent:PRIority` on page 318

Zero - Power Sensors

Activates the auto zero function.

Zeroing calibrates the external power sensor by adjusting its reading at zero signal power. For this purpose, the RF power source must be switched off or disconnected from the sensor. If a Rohde & Schwarz power sensor receives an input power during the zeroing process, it aborts zeroing and generates an error message. Zeroing takes a few seconds, depending on the sensor model. Refer to the documentation of your power sensor for more information.

Tips for zeroing

When to perform zeroing:

- During warm up after switching on or connecting the instrument
- After a substantial change of the ambient temperature
- After fastening the power sensor module to an RF connector at high temperature
- After several hours of operation
- When low-power signals are to be measured, e.g. less than 10 dB above the lower measurement limit.
- Switch off the RF power source for zeroing, but do not disconnect it from the power sensor. This proceeding keeps the thermal equilibrium, and the zeroing process also compensates the noise that superimposes the measured signal (e.g. from a broadband amplifier).

Remote command:

`:SENSe<ch>[:POWer]:ZERO` on page 324

Source

Selects the source for measurement.

"RF" Measurement source is the RF signal of the generator. The RF frequency is used as the measurement frequency of the sensor and the corresponding correction factor is used.

In this mode the RF frequency of the generator is sent to the sensor automatically if changed.

"User" Measurements source is any freely selectable source. The frequency is entered manually under frequency (e.g. for measurement of amplifier gain with 2 sensors).

Remote command:

`:SENSe<ch>[:POWer]:SOURce` on page 323

Frequency

Source User only

Enters the frequency for measurement source "User".

Remote command:

`:SENSe<ch>[:POWer]:FREQuency` on page 321

Level Offset

Activates and defines a level offset which is added to the measured value. This allows e.g. an attenuator in the signal path to be considered. The offset is always entered in dB, irrespective of the selected unit for result display.

Remote command:

`:SENSe<ch>[:POWer]:OFFSet:STATe` on page 322

`:SENSe<ch>[:POWer]:OFFSet` on page 322

Filter

Determines the length of the filter used for the measurement. The filter length affects the measurement time directly.

The averaging filter is used to reduce fluctuations in the measured result to the extent desired. Such fluctuations can be caused by inherent noise of the measuring instrument, modulation of the measurement signal or beats from the superposition of adjacent carriers. A more stable display has to be traded off against longer measurements. The measurement result is obtained from a two-stage averaging process.

Note: Longer measurements do not mean that it takes longer to display a new result, but rather that it takes longer for the result to settle when the power changes.

Measurements are continuously repeated in a predefined time window. The measurement result is obtained by averaging the measured values for the last 2N time windows. The number N is the filter length, the factor of 2 arises because the output signals from the microwave detector to suppress low-frequency noise are chopped at the same rate as the time windows, which means that an independent measured value can only be obtained from two consecutive values. As the filter length is the multiplier for the time window it directly influences the measurement time.

The filter length can be selected automatically or can be manually set to a fixed value. As a preliminary, you should always check if the auto mode is giving satisfactory results because you will always have to adjust an optimal, manual filter-length setting if the power is not constant.

Selection "Fixed Noise" is offered for achieving defined measurement accuracy.

"Auto" The filter length is automatically selected and adapted to the currently measured value. With very high signals the filter length and therefore the measurement time can be short. With very low signal levels the filter length and therefore the measurement time is increased in order to reduce noise. The used filter length is indicated in the field to the right, see [Filter Length](#).

"User" The filter length is set manually. The filter length is entered in the entry window to the right. As the filter length works as a multiplier for the time window, this results in a constant measurement time.

Note: The time window varies depending on the used sensor. For most sensors it is fixed to 20 ms. For the R&S NRP-Z81 sensor it is 10 us. Therefore, the user filter length for the R&S NRP-Z81 has been about 1000 times larger than the filter length for other sensors in order to achieve the same filtering result.

The [Auto Once](#) button can be used to search for the optimum filter length for the current measurement conditions. The found filter length is indicated in the field to the right, see [Filter Length](#).

"Fixed Noise" The averaging factor is selected so that the sensors intrinsic noise (2 standard deviations) does not exceed the specified noise content. The desired noise content is entered in the entry field to the right, see [Noise Content](#).

To avoid very long settling times when the power is low, the averaging factor can be limited with the [Timeout](#) parameter.

Remote command:

`:SENSe<ch>[:POWER]:FILTer:TYPE` on page 320

Filter Length ← Filter

Indicates the used filter length for filter type "Auto" or "User".

Remote command:

`:SENSe<ch>[:POWER]:FILTer:LENGth:AUTO?` on page 318

`:SENSe<ch>[:POWER]:FILTer:LENGth[:USER]` on page 319

Noise Content ← Filter

Sets the noise content for filter type "Fixed Noise".

Remote command:

`:SENSe<ch>[:POWER]:FILTer:NSRatio` on page 319

Timeout ← Filter

Sets a time limit for the averaging process.

Remote command:

`:SENSe<ch>[:POWER]:FILTer:NSRatio:MTIME` on page 320

Auto Once ← Filter

Calculates the optimum filter length for the current measurement conditions and indicates the value in the [Filter Length](#).

Remote command:

`:SENSe<ch>[:POWer]:FILTer:SONCe` on page 320

Use Default Aperture Time

Enables you to specify a user-defined aperture time for the respective sensor.

The sensor default setting is usually sufficient. If however, the readings vary, it is recommended that you adjust the aperture time exactly to one modulation period, in order to obtain stable readings. To specify the aperture time, see [Aperture Time](#).

Remote command:

`:SENSe<ch>[:POWer]:APERTure:DEFault:STATe` on page 316

Aperture Time

Defines the acquisition time for the respective sensor, provided the entry field is enabled, see [Use Default Aperture Time](#).

For example you can adjust the aperture time exactly to one signal period, in order to obtain a sufficient low average value.

Remote command:

`:SENSe<ch>[:POWer]:APERTure:TIME` on page 316

Use SParameter - Power Sensors

Activates the use of the S-Parameter correction data of the connected power sensor. For sensors with attenuator this checkbox is automatically checked.

Refer to the manual of the connected R&S NRP-Zxx power sensor for a description on how to use the SParameter table.

Remote command:

`:SENSe<ch>[:POWer]:CORRection:SPDevice:STATe` on page 317

Enable Logging

Activates recording of R&S NRP-Z power sensor readings.

If enabled, every value measured by a connected power sensor and indicated in the user interface, is written to a log file. Per measurement the function logs the measured value (2 readings when you work with peak sensors), the sensor type and the measurement time (time stamp).

The function automatically creates the file name `SensLog<n>.txt` and stores the file in `*txt` format under `/var/user/SensorLogging` on the hard disk. You can enable logging for each connected sensor separately. If enabled, one file per sensor is written.

Note: This specific function is intended for measurements with long time intervals, or if there is a risk that the connection to the sensor can be interrupted and you need the data for reconstruction.

The simplified recording function continuously writes the values in the file of the corresponding sensor number, like `Sens1Log.txt`. When you start a new measurement, the existing data will not be overwritten, but added to the file.

If you use this function, it is recommended that you regularly remove the files from the hard disk, since they require storage capacity.

Remote command:

`:SENSe<ch>[:POWer]:LOGGing:STATe` on page 321

5.3.7 RF Sweep and List Mode

5.3.7.1 Overview

The R&S SMB offers three different sweep types (frequency sweep, level sweep and LF sweep) to be activated alternatively. Each type has 6 modes which differ with respect to the sweep cycle mode (continuous, individual and step-by-step) and triggering mode (automatic, internal and external).



- Sweeps and list mode can not be activated simultaneously, they deactivate each other.
- Activating a sweep mode immediately disables [NRP-Z Level Control](#). Vice versa, a running sweep mode blocks "NRP-Z Level Control". It can not be activated.
- If you want to remain at a specific frequency or level value during a sweep, enter the value directly in the status bar. The sweep stops immediately.

Setting a sweep

A sweep is set in five basic steps which are shown below taking a frequency sweep as an example.



The LF sweep is activated and configured in the "Mod Gen" block.

1. Set the sweep range ("Start Freq" and "Stop Freq" or "Center Freq" and "Span").
2. Select linear or logarithmic sweep spacing ("Spacing").
3. Set the step width ("Step Lin/Log") and dwell time ("Dwell Time").
4. Activate the sweep ("Mode" to Auto, Single, Step or Extern Single, Extern Step).
5. Trigger the sweep, except for Auto mode ("Execute Single Sweep", Current Frequency or External Trigger Signal).



It is recommended to switch off the display update for optimum sweep performance especially with short dwell times (see [Chapter 5.2.3.7, "Display Update"](#), on page 100).

5.3.7.2 RF Frequency Sweep

The dialog enables you to activate and configure a sweep for the RF frequency.

To open the "RF Frequency Sweep" dialog, select "RF > Configure > RF Frequency Sweep" or use the MENU key under "RF".

In the top section of the dialog, the RF sweep is activated and the sweep mode is selected.

The buttons are used to reset the RF sweep (all sweep modes) or to execute the RF sweep ("Single" mode).

The sweep range, sweep spacing and dwell time are set in the bottom section.

For the frequency sweep, an output signal at the LF connector can be activated. It provides a linear voltage ramp from start to stop of the sweep. The output voltage can be used for example to control an oscilloscope.

You can configure the sweep range of the RF sweep in two ways, either by entering the "Start" and "Stop" values or by entering the "Center" frequency and the "Span".

The two sets of parameters correlate as follows:

- "Start Freq" = "Center Freq" - "Span"/2
- "Stop Freq" = "Center Freq" + "Span"/2
- "Center Freq" = ("Start Freq" + STOP FREQ)/2
- "Span" = "Stop Freq" - "Start Freq"

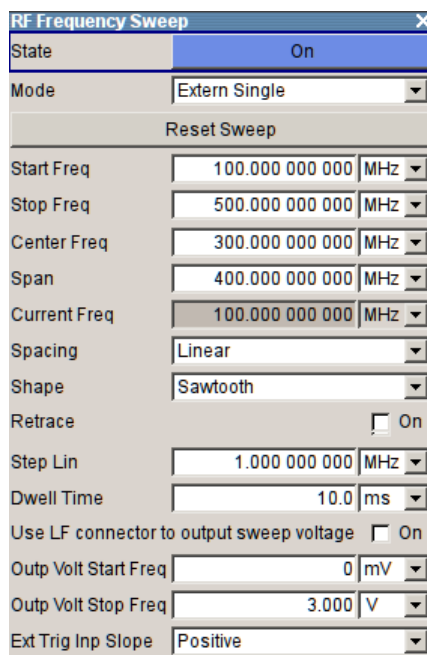
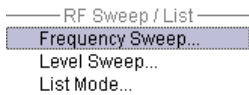

RF Frequency Sweep Settings

- ▶ To access the sweep dialog, select "RF > configure > Sweep/List > RF Frequency Sweep".

In these dialogs you can configure the corresponding sweep signal.

State - Frequency Sweep

Activates RF sweep mode.

Note:

Activating a sweep mode automatically deactivates other sweeps and the list mode.

Remote command:

[:SOURce<hw>] :FREQuency:MODE on page 343

Mode - RF Frequency Sweep

Selects the RF frequency sweep mode.

If you change the sweep mode during the execution, the signal generator stops the sweep and starts with the next trigger event at the initial value.

The "Reset Sweep" button sets the sweep to the start value.

"Auto" Generates a continuously repeating sweep signal immediately after activating the sweep mode.
The sweep steps are performed automatically, controlled by the dwell time, see "Dwell Time - Frequency Sweep" on page 181.

Example:

```
SOUR:SWE:FREQ:MODE AUTO
TRIG:FSW:SOUR AUTO
SOUR:FREQ:MODE SWE
```

"Single" Generates a single sweep cycle after a trigger event.
The sweep steps within the cycle are performed automatically, controlled by the dwell time. If one cycle is completed, the instrument waits for the next trigger event.
To trigger the sweep, use "Execute Single Sweep" button, or the corresponding remote control commands, for example *TRG.

Example:

```
SOUR:SWE:FREQ:MODE AUTO
TRIG:FSW:SOUR SING
SOUR:FREQ:MODE SWE
SOUR:SWE:FREQ:EXEC
```

"Step" Generates the sweep signal step-by-step, manually triggered. To perform the sweep steps, enter the frequency value under [Current Freq - Frequency Sweep](#). You can directly enter the value, but also use the UP and DOWN navigation keys or the ROTARY KNOB. You can determine the step width below in the entry field "Step Lin" or "Step Log", see [Step Lin/Log - Frequency Sweep](#). If a step is out of the sweep range ("Start Freq" or "Stop Freq"), it is ignored.

Note: To step through the sweep frequencies in remote control mode, use the `FREQ:MAN` command with the `UP` or `DOWN` parameter.

Example:

```
SOUR:FREQ:CENT 300MHz
SOUR:FREQ:SPAN 400MHz
SOUR:SWE:FREQ:SPAC LIN
SOUR:SWE:FREQ:STEP:LIN 100MHz
SOUR:FREQ:MODE MAN
TRIG:FSW:SOUR SING
```

set sweep mode "Step".

```
SOUR:FREQ:MODE SWE
```

activate sweep mode, the frequency is set to "Start Freq".

```
SOUR:FREQ:MAN UP
```

set the frequency to the next higher sweep frequency.

```
SOUR:FREQ:MAN DOWN
```

set the frequency to the next lower sweep frequency.

"Extern Single" Generates a single sweep cycle when an external trigger event occurs.

The sweep steps within the cycle are performed automatically, controlled by the dwell time. If one cycle is completed, the instrument waits for the next trigger event.

To trigger the sweep, apply an external trigger signal.

Refer to the description of the rear panel for information on the connectors for external trigger signal input (see [Chapter 2.2, "Rear Panel Tour"](#), on page 21).

Example:

```
SOUR:SWE:FREQ:MODE AUTO
TRIG:FSW:SOUR EXT
SOUR:FREQ:MODE SWE (External trigger)
```

"Extern Step" Generates the sweep signal step-by-step, manually triggered. To trigger a sweep step, apply an external trigger signal. The step width corresponds to the step width set for the rotary knob.

Example:

```
SOUR:SWE:FREQ:MODE STEP
SOUR:SWE:FREQ:SPAC LIN
SOUR:SWE:FREQ:STEP:LIN 1MHz
TRIG:FSW:SOUR EXT
SOUR:FREQ:MODE SWE (External trigger)
```

"Extern Start/Stop"

Generates a continuously repeating sweep signal that is started, stopped and restarted by subsequent external trigger events. The sweep steps are performed automatically, controlled by the dwell time.

Refer to the description of the rear panel for information on the connectors for external trigger signal input (see [Chapter 2.2, "Rear Panel Tour"](#), on page 21).

Example:

```
SOUR:SWE:FREQ:MODE AUTO
TRIG:FSW:SOUR EAUT
SOUR:FREQ:MODE SWE (External trigger)
```

Remote command:

```
[ :SOURce<hw> ] :SWEep [ :FREQuency ] :MODE on page 419
:TRIGger<hw> :FSWEEP :SOURce on page 450
[ :SOURce<hw> ] :FREQuency :MODE on page 343
```

Execute Single Sweep - Frequency Sweep

Starts a sweep manually. This trigger button is displayed in "Single" mode.

Remote command:

```
[ :SOURce<hw> ] :SWEep [ :FREQuency ] :EXECute on page 419
:TRIGger<hw> :FSWEEP [ :IMMediate ] on page 451
:TRIGger<hw> [ :SWEep ] [ :IMMediate ] on page 455
```

Reset Sweep - Frequency Sweep

Resets the sweep.

With the next trigger event, the sweep starts with at the initial value.

Remote command:

```
[ :SOURce<hw> ] :SWEep:RESet [ :ALL ] on page 429
```

Start Freq - Frequency Sweep

Sets the start frequency.

Remote command:

```
[ :SOURce<hw> ] :FREQuency :START on page 345
```

Stop Freq - Frequency Sweep

Sets the stop frequency.

Remote command:

[\[:SOURce<hw>\]:FREQuency:STOP](#) on page 346

Center Freq - Frequency Sweep

Sets the center frequency.

Remote command:

[\[:SOURce<hw>\]:FREQuency:CENTer](#) on page 341

Span - Frequency Sweep

Sets the span.

Remote command:

[\[:SOURce<hw>\]:FREQuency:SPAN](#) on page 345

Current Freq - Frequency Sweep

Displays the current frequency.

In sweep "Step" mode, the parameter is editable and you can enter frequency for the next step.

Remote command:

[\[:SOURce<hw>\]:FREQuency:MANual](#) on page 342

Spacing - Frequency Sweep

Selects the mode for the calculation of the frequency sweep intervals.

"Linear" Takes the frequency value entered as an absolute value in Hz.

"Logarithmic" Takes the value entered as a logarithmic value, that means as a constant fraction of the current frequency in %.

Remote command:

[\[:SOURce<hw>\]:SWEep\[:FREQuency\]:SPACing](#) on page 423

Shape - RF Frequency Sweep

Selects the waveform shape of the sweep signal.

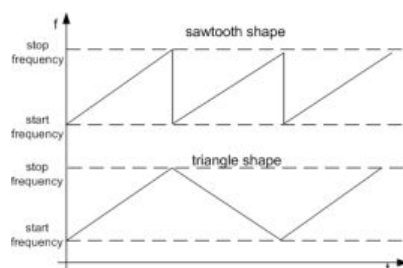

"Sawtooth" One sweep runs from start to stop frequency. Each subsequent sweep starts at the start frequency, that means the shape of the sweep sequence resembles a sawtooth.

"Triangle" The sweep runs from the start to the stop frequency and back, that means the shape of the sweep resembles a triangle. Each subsequent sweep starts at the start frequency.

Remote command:

[:SOURce<hw>] :SWEep [:FREQuency] :SHAPE on page 422

Retrace - RF Frequency Sweep

Activates that the signal changes to the start frequency value while it is waiting for the next trigger event.

You can enable this feature, when you are working with sawtooth shapes in sweep mode "Single" or "External Single", see [Mode - RF Frequency Sweep](#).

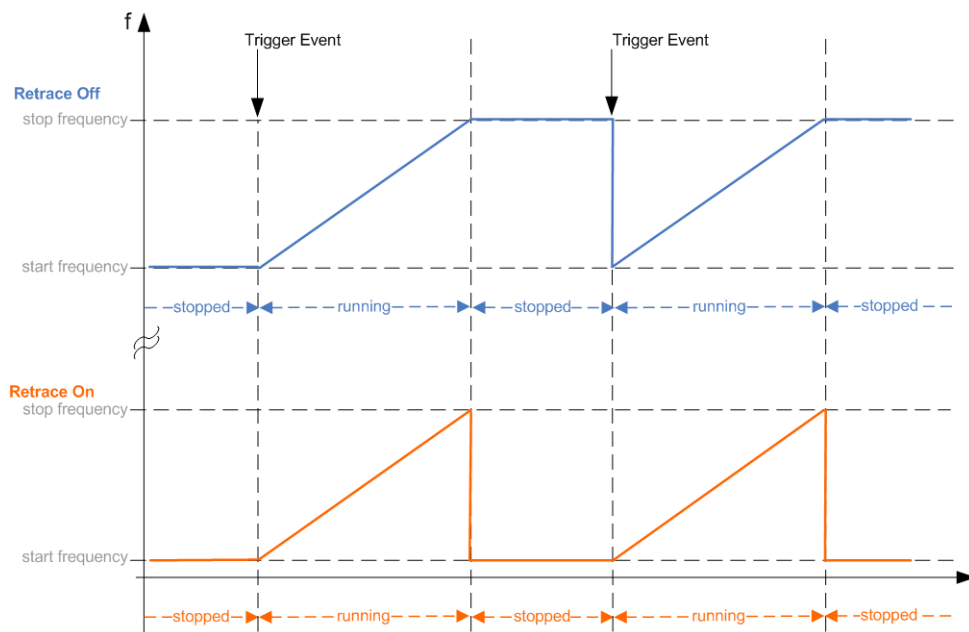

Remote command:

[:SOURce<hw>] :SWEep [:FREQuency] :RETRace on page 422

Step Lin/Log - Frequency Sweep

Sets the step width for the individual frequency sweep steps.

At each step this value is added to the current frequency.

Depending on the [Spacing - Frequency Sweep](#) mode you have set, the corresponding parameter is displayed.

"Step Lin" The step width is a constant value in Hz.

Remote command:

[:SOURce<hw>] :SWEep [:FREQuency] :STEP [:LINear] on page 423

"Step Log" The step width is determined logarithmically in %, that means as a constant fraction of the current frequency. Successive frequencies are calculated as follows:

- **start_f < stop_f**
 $f_2 = f_1 * (1 + \text{step_log} / 100)$
 If $f_2 > \text{stop_f}$: f_2 is set to stop_f .
- **start_f > stop_f**
 $f_2 = f_1 / (1 + \text{step_log} / 100)$
 If $f_2 < \text{stop_f}$: f_2 is set to stop_f .

When the shape "Triangle" is set, the frequency values on the slope from **stop_f back to start_f** are the same as on the slope from **start_f to stop_f**.

Remote command:

`[:SOURce<hw>] :SWEep [:FREQuency] :STEP:LOGarithmic` on page 424

Dwell Time - Frequency Sweep

Sets the dwell time. The dwell time determines the duration of the individual sweep steps.

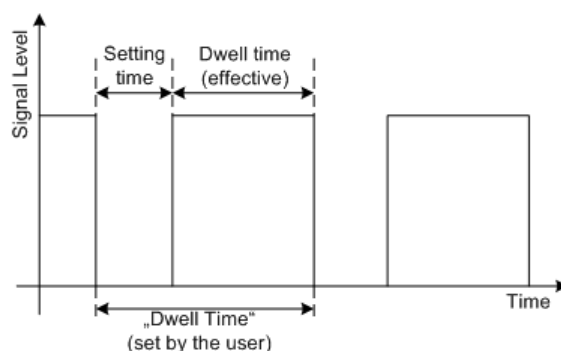

The "Dwell Time" set by the user is used as the step time of the sweep. The effective net dwell time is shorter, reduced by the setting time. This setting time may be greater than the time specified in the data sheet.

Note:

It is recommended to switch off the display update for optimum sweep performance especially with short dwell times (see [Chapter 5.2.3.7, "Display Update"](#), on page 100).

Remote command:

`[:SOURce<hw>] :SWEep [:FREQuency] :DWELL` on page 418

Use LF connector to output sweep voltage - RF Frequency Sweep

Activates the output of a linear voltage ramp from sweep start to sweep stop at the LF connector. This signal can be used for the X-deflection of an oscilloscope. The voltage range is determined below.

Remote command:

`[:SOURce<hw>] :SWEep [:FREQuency] :LFConnector` on page 419

Output Voltage Start Freq - RF Frequency Sweep

Sets the voltage at the sweep start frequency.

Remote command:

[:SOURce<hw>] :SWEep [:FREQuency] :OVOLtage :START on page 420

Output Voltage Stop - RF Frequency Sweep

Sets the voltage at the sweep stop frequency.

Remote command:

[:SOURce<hw>] :SWEep [:FREQuency] :OVOLtage :STOP on page 421

Ext. Trigger Input Slope

Sets the polarity of the active slope of an externally applied instrument trigger.

This setting affects the INST TRIG input (BNC connector at the rear of the instrument).

"Positive" activates the rising edge of the trigger signal.

"Negative" activates the falling edge of the trigger signal.

Remote command:

[:SOURce] :INPut :TRIGger :SLOPe on page 348

5.3.7.3 RF Level Sweep

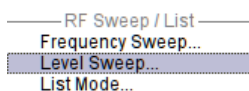

To open the "Level Sweep" menu, select "RF > Configure > Level Sweep" or use the MENU key under "RF".

RF Level Sweep Settings

In the top section, the RF level sweep is activated and the sweep mode is selected. The buttons are used to reset the level sweep (all sweep modes) or to execute the level sweep ("Single" mode).

The sweep range, sweep spacing and dwell time are set in the bottom section.

RF Level Sweep	
State	On
Mode	Extern Single
Reset Sweep	
Start Level	-30.00 dBm
Stop Level	-10.00 dBm
Current Level	-30.00 dBm
Shape	Sawtooth
Retrace	<input type="checkbox"/> On
Step	1.00 dB
Dwell Time	10.0 ms
Ext Trigger Input Slope	Positive

State - Level Sweep

Activates Level Sweep mode.

Note:

Activating a sweep mode automatically deactivates other sweeps and the list mode.

Remote command:

[:SOURce<hw>] :POWer:MODE on page 382

Mode - Level Sweep

Selects the level sweep instrument operating mode and the sweep mode.

If you change the sweep mode during the execution, the signal generator stops the sweep and starts with the next trigger event at the initial value.

The "Reset Sweep" button sets the sweep to the start value.

"Auto" Sets an automatically repeated sweep cycle.

Example:

```
SOUR:SWE:POW:MODE AUTO
TRIG:PSW:SOUR AUTO
SOUR:POW:MODE SWE
```

"Single" Sets a single sweep cycle. The sweep is triggered by the "Execute Single Sweep" button, or by means remote trigger commands, e.g. *TRG.

Example:

```
SOUR:SWE:POW:MODE AUTO
TRIG:PSW:SOUR SING
SOUR:POW:MODE SWE
SOUR:SWE:POW:EXEC
```

"Step" Sets a step-by-step sweep cycle. If this mode is activated, the cursor moves to the value displayed for "Current Level". Each sweep step is triggered by a variation of the value in the "Current Level" entry window. The step width is set below at entry field "Step".
If this mode is activated, the cursor moves to the value displayed for "Current Level". If a different sweep mode was activated prior to the "Step" mode, the current sweep is stopped. The step sweep starts at the current level value.

Example:

```
SOUR:SWE:POW:MODE MAN
TRI:PSW:SOUR SING
SOUR:SWE:POW:STEP 0.5
SOUR:POW:MODE SWE
SOUR:POW:MAN -16
```

The value entered with command `SOUR:SWE:POW:STEP` sets the step width.

The value entered with command `SOUR:POW:MAN` has no effect, the command only triggers the next sweep step. However, the value has to be in the currently set sweep range (start to stop). In remote control only a step-by-step sweep from start to stop frequency is possible.

"Extern Single" Sets a single sweep cycle. The sweep is triggered by an external trigger signal. Refer to the description of the rear panel for information about the connectors for external trigger signal input (see [Chapter 2.2, "Rear Panel Tour"](#), on page 21).

Example:

```
SOUR:SWE:POW:MODE AUTO
TRIG:PSW:SOUR EXT
SOUR:POW:MODE SWE (External trigger)
```

"Extern Step" Sets a step-by-step sweep cycle. Each sweep step is triggered by an external trigger signal (trigger source as described under "Extern Single"). The step width corresponds to the step width of the rotary knob.

Example:

```
SOUR:SWE:POW:MODE STEP
SOUR:SWE:POW:STEP 0.5
TRIG:PSW:SOUR EXT
SOUR:POW:MODE SWE (External trigger)
```

"Extern Start/Stop"

Sets an automatically repeated sweep cycle that is started, stopped and restarted by subsequent external trigger events.

The first external trigger signal starts the sweep (Start).

The next external trigger signal stops the sweep at the current frequency (Stop).

The third external trigger signal starts the sweep at the start frequency (Start).

Refer to the description of the rear panel for information about the connectors for external trigger signal input (see section "Legend for Rear Panel View").

Example:

```
SOUR:SWE:POW:MODE AUTO
TRIG:PSW:SOUR EAUT
SOUR:POW:MODE SWE (External trigger)
```

Remote command:

[\[:SOURce<hw>\]:SWEep:POWer:MODE](#) on page 425

[:TRIGger<hw>:PSWeep:SOURce](#) on page 453.

[\[:SOURce<hw>\]:POWer:MODE](#) on page 382

Reset Sweep - Level Sweep

Resets the sweep. The start level is set and the next sweep starts from there.

Remote command:

[\[:SOURce<hw>\]:SWEep:RESet \[:ALL\]](#) on page 429

Execute Single Sweep - Level Sweep

Triggers the sweep manually. A manual sweep can only be triggered if "Mode Single" is selected.

Example:

```
SOUR:SWE:POW:MODE AUTO
TRIG:PSW:SOUR SING
SOUR:POW:MODE SWE
SOUR:SWE:EXEC
```

Remote command:

[\[:SOURce<hw>\]:SWEep:POWer:EXECute](#) on page 425

[:TRIGger<hw>:PSWeep\[:IMMediate\]](#) on page 453

[:TRIGger<hw>\[:SWEep\]\[:IMMediate\]](#) on page 455

Start Level - Level Sweep

Sets the start level.

Remote command:

[\[:SOURce<hw>\]:POWer:START](#) on page 385

Stop Level - Level Sweep

Sets the stop level.

Remote command:

`[:SOURce<hw>] :POWer:STOP` on page 387

Current Level - Level Sweep

Displays the current level.

If "Step" is set, the level for the next level step of the sweep is entered here.

Remote command:

`[:SOURce<hw>] :POWer:MANual` on page 382

Shape - RF Level Sweep

Selects the cycle mode for a sweep sequence (shape).

"Sawtooth" One sweep runs from the start level to the stop level. The subsequent sweep starts at the start level again, i.e. the shape of sweep sequence resembles a sawtooth.

"Triangle" One sweep runs from start to stop level and back, i.e. the shape of the sweep resembles a triangle. Each subsequent sweep starts at the start level again.

Remote command:

`[:SOURce<hw>] :SWEep:POWer:SHAPE` on page 427

Retrace - RF Level Sweep

Activates that the signal changes to the start level value while it is waiting for the next trigger event. It allows you to shift down the power during the waiting period.

You can enable this feature, when you are working with sawtooth shapes in sweep mode "Single" or "External Single", see [Mode - Level Sweep](#).

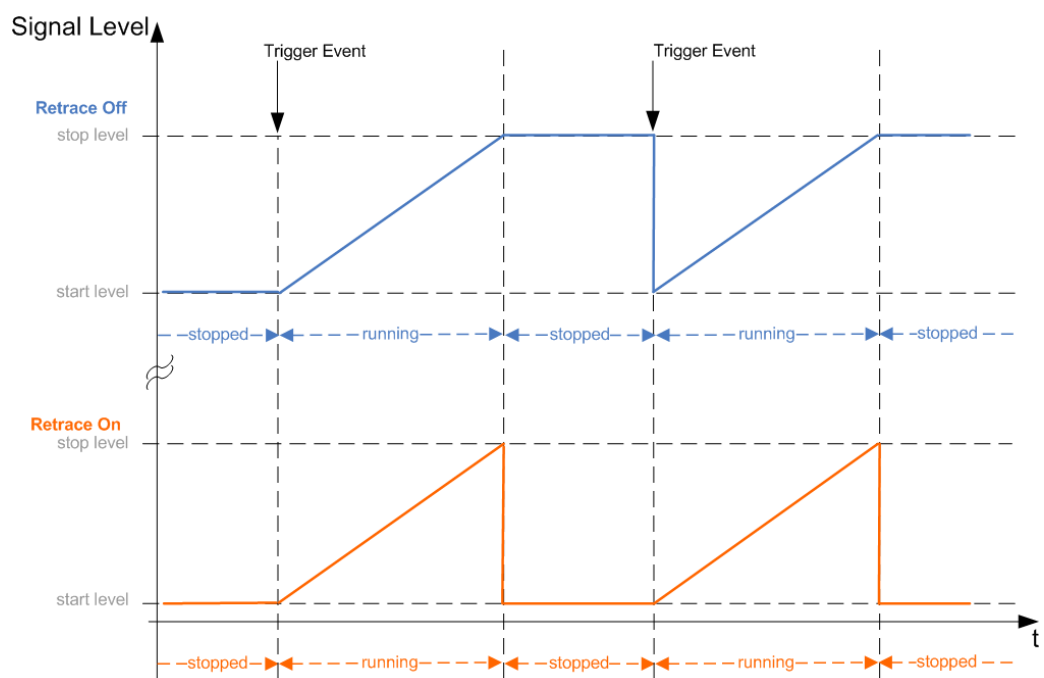

Remote command:

[\[:SOURce<hw>\]:SWEep:POWer:RETRace](#) on page 427

Step - Level Sweep

Sets the step width for the individual sweep steps. This entry is effective for all sweep modes.

With the level sweep, the logarithmic step width is a constant fraction of the current level. This fraction is added to the current level. The logarithmic step width is entered in dB.

Remote command:

[\[:SOURce<hw>\]:SWEep:POWer:STEP\[:LOGarithmic\]](#) on page 428

Dwell Time - Level Sweep

Enters the dwell time and determines the duration of the individual sweep steps.

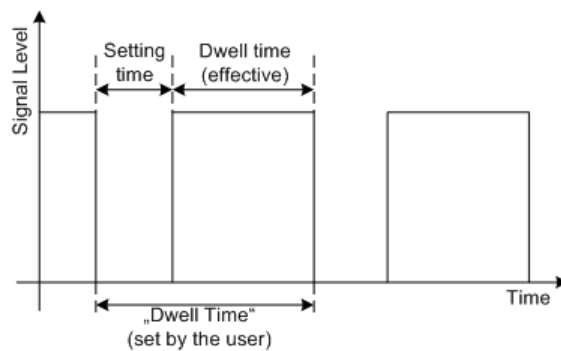

The "Dwell Time" set by the user is used as the step time of the sweep. The effective net dwell time is shorter, reduced by the setting time. This setting time may be greater than the time specified in the data sheet.

Note:

It is recommended to switch off the display update for optimum sweep performance especially with short dwell times (see [Chapter 5.2.3.7, "Display Update"](#), on page 100).

Remote command:

[\[:SOURce<hw>\]:SWEep:POWer:DWELL](#) on page 425

Ext. Trigger Input Slope

Sets the polarity of the active slope of an externally applied instrument trigger.

This setting affects the INST TRIG input (BNC connector at the rear of the instrument).

"Positive" activates the rising edge of the trigger signal.

"Negative" activates the falling edge of the trigger signal.

Remote command:

[\[:SOURce\]:INPut:TRIGger:SLOPe](#) on page 348

5.3.7.4 List Mode

Similar to a sweep, a series of previously defined frequency and level points is processed in List mode. In contrast to a sweep, however, a list with freely selectable value

pairs (frequency and level) can be created. The value range for frequency and level covers the entire configurable value range of the instrument.



Interactions between List mode and other operating modes or settings

- List mode and sweeps can not be activated simultaneously, they deactivate each other.
- Activating the list mode instantly disables [NRP-Z Level Control](#). A running list mode blocks "NRP-Z Level Control". It can not be activated

The lists can be created in the "List Editor". Each list is stored in its own file with the predefined file extension *.lsw. The name of the list file can be freely selected. The files are loaded from the "Lists..." file manager. Externally created tables with pairs of frequency and level values can be converted into List files using the import function. The external files must have the file extension *.txt or *.csv. These file formats are provided e.g. by the Microsoft®Excel program. The separators for table columns and for decimal floating-point numerals can be set. In addition, internally created List data can be exported into ASCII files using the export function.

The necessary hardware settings are calculated the first time a list is processed. With long dwell times, this calculation can be performed while the list is being processed; the entered dwell times are observed. With very short dwell times, calculation of the hardware settings increases the dwell time for the initial processing cycle; the entered value is only observed from the second processing cycle onwards. In this case a message appears to inform the user that there is a deviation between the current and set dwell times. No further calculations are required after the first run through a list. The current dwell times will definitely no longer deviate from the set dwell times.

The list is processed from the beginning to the end of the list (modes "Auto", ("External") "Single", ("External") "Step").

List Mode Dialog

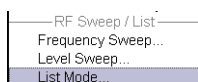

To open the "List Mode" menu, select "RF > Configure > List Mode" or use the MENU key under "RF".

The menu is used to activate/deactivate the operating mode List, to create, select and activate the lists, and to select the trigger mode and the dwell time.

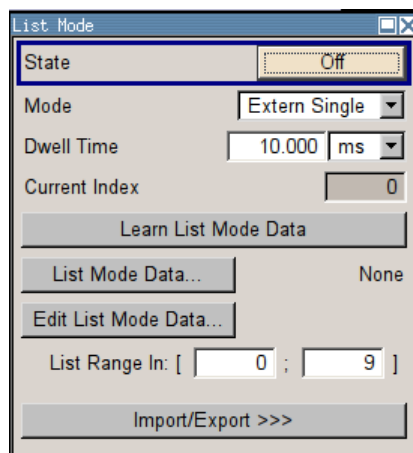

General Settings

State - List Mode

Activates/deactivates the List mode. The currently selected list is processed.

In case of a new or modified list, the necessary hardware settings are automatically determined on activation of the list mode. The data determined in this way is stored along with the list and is available whenever the list is used again.

This means that when activating the list mode, the system checks whether any hardware settings are present. If so, the list is started immediately, but if not they are automatically determined (the list is learnt).

A "Learn List Mode Data" button is available for deliberately activating list learning.

Note: Activating the list mode automatically deactivates all sweeps. During list mode the frequency and level indications do not display the currently set values.

Remote command:

[:SOURce<hw>] :FREQuency:MODE on page 343

Mode - List Mode

Selects the cycle mode of the List mode.

- | | |
|----------|---|
| "Auto" | Cycle from the beginning to the end of the list with automatic restart at the beginning. If a different mode was activated prior to the Auto mode, the cycle continues from the beginning of the list. The duration of a list step is determined by the set dwell time. Button "Reset" restarts the list at the starting point. |
| "Single" | Single cycle from the beginning to the end of the list. If "Single" is selected, the cycle is not started immediately. The "Execute Single" button appears under the "Mode" line. The cycle is started with this button. The duration of a list step is determined by the set dwell time. Button "Reset" restarts the list at the starting point. |



"Step" Manual, step-by-step processing of the list. Activating "Step" stops the current list and the cursor moves to the value displayed for "Current Index". It is now possible to scroll up and down in the list in discrete steps by varying the index. The duration of a list step is determined by the time between two index entries. Button "Reset" restarts the list at the starting point.



"Extern Single" Single cycle from the beginning to the end of the list as with "Single", but started by an external trigger. The external trigger signal is input at the BNC connector INST TRIG. Button "Reset" restarts the list at the starting point.

"Extern Step" Step-by-step cycle using the external trigger signal. Each trigger event starts a single step. The duration of a list step is determined by the time between two trigger events. The external trigger signal is input at the BNC connector INST TRIG. Button "Reset" restarts the list at the starting point.

Remote command:

[\[:SOURce<hw>\]:LIST:MODE](#) on page 368

[\[:SOURce<hw>\]:LIST:TRIGger:SOURce](#) on page 370

Execute Single - List Mode

Triggers the list manually. This button is available only if mode "Single" is selected.

Remote command:

[\[:SOURce<hw>\]:LIST:TRIGger:EXECute](#) on page 370

Reset - List Mode

Resets the list to the starting point.

Remote command:

[\[:SOURce<hw>\]:LIST:RESet](#) on page 369

Dwell Time - List Mode

Enters the dwell time. The dwell time determines the duration of a list step in list operating modes "Auto", "Single" and "Extern Single". In these modes a complete list is processed either once or continuously.

In list operating modes "Step" and "Extern Step", the set dwell time does not affect signal generation. In this case, the duration of a list step is determined by the time between two (internal or external) trigger events.

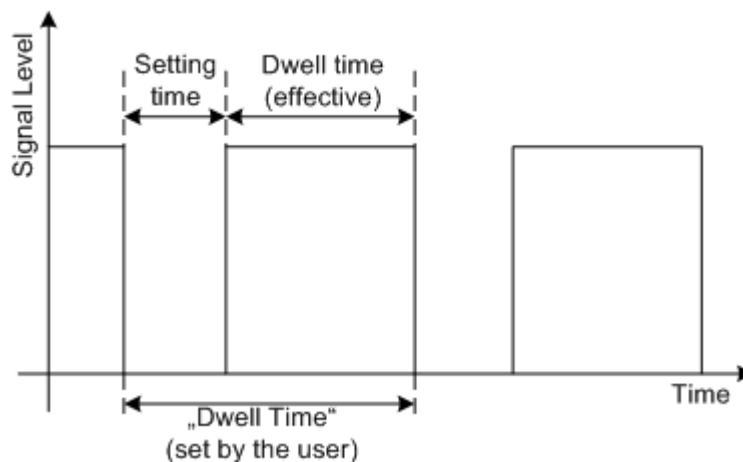

The "Dwell Time" set by the user is used as the step time of the list mode. The effective net dwell time is shorter, reduced by the setting time. This setting time may be greater than the time specified in the data sheet.

Remote command:

[\[:SOURCE<hw>\]:LIST:DWELL](#) on page 365

Current Index - List Mode

Sets the list index in "Step" mode.

Remote command:

[\[:SOURCE<hw>\]:LIST:INDEX](#) on page 366

Learn List Mode Data... - List Mode

Starts the determination of the hardware setting for the selected list. The data determined in this way is stored along with the list.

It may be necessary to deliberately activate list learning in the event of greatly altered environmental conditions that require new hardware settings.

If this is not done, a previously learned hardware setting will continue to be used when list mode is switched on ("State = On"). If no setting is available, e.g. when the list is used for the first time, learning is automatically activated.

Remote command:

[\[:SOURCE<hw>\]:LIST:LEARN](#) on page 368

List Mode Data... - List Mode

Calls the "File Select" menu for selecting and creating a list or the "File Manager".



Remote command:

[\[:SOURCE<hw>\]:LIST:SELEct](#) on page 370

[\[:SOURCE<hw>\]:LIST:DELEte](#) on page 360

[\[:SOURCE<hw>\]:LIST:DELEte:ALL](#) on page 361

Edit List Mode Data... - List Mode

Calls the editor for editing the selected list. A list consists of any number of frequency/level value pairs. The currently selected list is displayed.

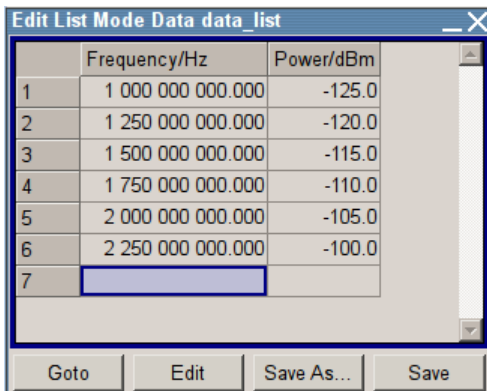

"Frequency / Hz" Enter the frequency of the frequency/power value pair.

Remote command:

[:SOURce<hw>] :LIST:FREQuency on page 365

"Power /dBm" Enter the level of the frequency/power value pair.

Remote command:

[:SOURce<hw>] :LIST:POWer on page 368

"Goto" Selects row for editing.



If "Goto row" is selected, a window opens for entering the requested row.

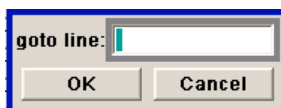

"Edit" Calls a selection of possible actions described below.



"Insert Row" Inserts a new row before the marked row.

"Insert Range" Inserts new rows before the marked row. The number of rows to be inserted can be defined in an entry window.

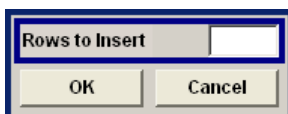

- "Fill..." Opens a sub menu for defining a set of list values to be automatically entered in the List Mode table (see ["Filling the List Mode Data automatically"](#) on page 195).
- "Delete Row" Deletes the marked row.
- "Delete Range..." Allows to delete any number of rows starting with the marked row. The number of rows to be deleted can be defined in an entry window.

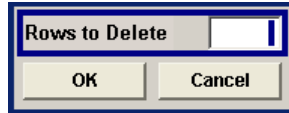

- "Save" The list is saved under its current name.

List Range In - List Mode

Defines an index range in the current list by setting the start and stop index. Only the values in the selected index range are processed in List mode, all other list entries are ignored.

Remote command:

[\[:SOURce<hw>\]:LIST:INDEX:START](#) on page 367

[\[:SOURce<hw>\]:LIST:INDEX:STOP](#) on page 367

Ext. Trigger Input Slope

Sets the polarity of the active slope of an externally applied instrument trigger.

This setting affects the INST TRIG input (BNC connector at the rear of the instrument).

"Positive" activates the rising edge of the trigger signal.

"Negative" activates the falling edge of the trigger signal.

Remote command:

[\[:SOURce\]:INPut:TRIGger:SLOPe](#) on page 348

Import/Export

Lists can be imported from externally created files or exported into text or CSV-files. The import/export settings are available after clicking the "Import/Export" button.

Import/Export - List Mode

Expands the menu with the area for import and export of list mode files.

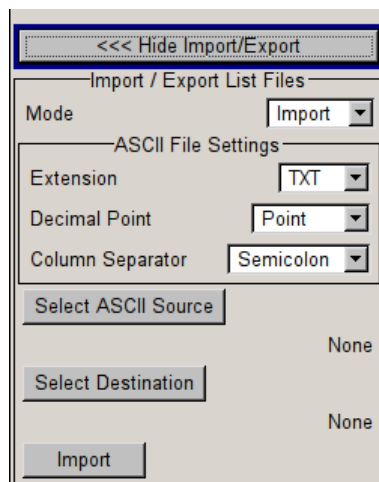

Externally edited Excel tables with frequency/level pairs can be imported as text or CSV-files and used for list mode.

On the other hand, internally created list mode lists can be exported as text or CSV-files.

Mode - List Mode

Selects if list mode lists should be imported or exported. The settings offered below depend on the selected mode.

Remote command:

[\[:SOURce<hw>\]:LIST:DEXChange:MODE](#) on page 364

Extension - List Mode

Selects the file extension of the ASCII file to be imported or exported. Selection TXT (text file) or CSV (Excel file) is available.

Remote command:

[\[:SOURce<hw>\]:LIST:DEXChange:AFILe:EXTension](#) on page 362

Decimal Point - List Mode

Selects the decimal separator used in the ASCII data between '.' (decimal point) and ',' (comma) with floating-point numerals.

Remote command:

[\[:SOURce<hw>\]:LIST:DEXChange:AFILe:SEParator:DECimal](#) on page 363

Column Separator- List Mode

Selects the separator between the frequency and level column of the ASCII table.

Remote command:

[\[:SOURce<hw>\]:LIST:DEXChange:AFILe:SEParator:COLumn](#) on page 363

Select ASCII Source / Destination - List Mode

Calls the "File Manager" for selecting the ASCII file to be imported into a list mode list (source) or the ASCII file the list mode list is exported (destination) in.

Remote command:

[\[:SOURce<hw>\]:LIST:DEXChange:AFILe:SELeCt](#) on page 362

Select Destination / Source - List Mode

Calls the "File Manager" for selecting the list mode list to be exported (source) into an ASCII file or the destination for the ASCII file to be imported (destination) in.

Remote command:

[:SOURce<hw>] :LIST:DEXChange:SElect on page 364

Import / Export - List Mode

Starts the export or import of the selected file.

When import is selected, the ASCII file is imported as list mode list.

When export is selected, the list mode list is exported into the selected ASCII file.

Remote command:

[:SOURce<hw>] :LIST:DEXChange:EXECute on page 363

Filling the List Mode Data automatically

The "Fill List Mode Data" menu enables you to automatically set the values in the List Mode table.

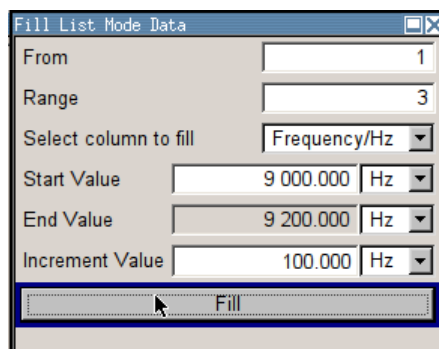

The start line and the number of rows to be filled are defined under "From" and "Range".

The column to be filled is selected under "Select column to fill". Depending on the selection here, the default for start, end, and increment value are set. As the settings are interdependent, a change of one parameter may result in the automatic change of one or more of the other parameters.

The filling of the column with the selected value settings is started with button "Fill".



The list entries are only computed when the "Fill" button is pressed.

From

Sets the start value of the index range.

Remote command:

n.a.

Range

Sets the range for filling the table.

Remote command:
n.a.

Select column to fill

Selects either the frequency or the level column to be filled with the value defined below.

Remote command:
n.a.

Start value

Sets the start value for the frequency or the level entries.

Remote command:
n.a.

End value

Sets the end value for the frequency or the level entries.

Remote command:
n.a.

Increment value

Sets the increment for the frequency or the level entries.

Remote command:
n.a.

Fill

Fills the selected column in the set range with values, starting with the start value and using the set increment.

Remote command:
n.a.

5.4 Modulation

5.4.1 Overview of Modulation

Analog modulation is a method used to transmit information of an LF (Low Frequency) signal in accordance with a second signal, typically one of a higher frequency. This is done by varying one or more properties of a high frequency waveform, called the modulation or carrier signal, with the modulating signal that contains the information to be transmitted.

The three key parameters of the modulation signal are the amplitude, phase and frequency. These parameters are modified in accordance with the low frequency signal to obtain the modulated RF signal.

The R&S SMB provides all the various types of modulation, such as:

- AM (Amplitude Modulation)
- FM (Frequency Modulation)
- PhiM (Phase Modulation)
- PULM (Pulse Modulation)
- Stereo Modulation

In addition, the RF signal can be modulated with various internally generated modulation waveforms, like sine or rectangular signal waves. The basic unit (R&S SMB + frequency option) provides amplitude, frequency and phase modulation without additional equipment options, as well as a standard LF generator provided for internal modulation. Further available options are:

- R&S SMB-B5, Stereo/RDS Coder for performing stereo modulation
- R&S SMB-K21, Pulse Modulation for instruments with high frequency options
- R&S SMB-K22, Pulse Modulation for instruments equipped with frequency-options up to 6 GHz
- R&S SMB-K23, Pulse Generator for pulse signals
- R&S SMB-K27 Pulse Train for generating pulse train signals (only for instruments with serial number higher than 102400)

Settings for the modulation are made in separate modulation menus. These menus can be accessed in the block diagram by way of the "Modulation" function block, or by means of the menu with the same name which is opened using the MENU key.

5.4.1.1 Enabling/Disabling Analog Modulations using the MOD On/Off Key

The MOD ON/OFF key switches the modulations on and off.

MOD ON/OFF

Press the MOD ON/OFF key to enable/disable analog modulations.

Pressing the key again restores the status that was active before the last switch-off. "MOD OFF" is displayed in the info line of the header next to the "Level" field.

Remote command:

`[:SOURce<hw>] :MODulation [:ALL] [:STATe]` on page 371

5.4.1.2 Modulation Sources

The following modulations use internal and external modulation sources:

- Amplitude modulation
- Pulse modulation
- Frequency modulation
- Phase modulation

Internal Modulation Sources

An LF generator and a pulse generator are available as internal modulation sources for a fully equipped instrument. The LF generator supplies sinusoidal or rectangular signals.

The optional pulse generator (option R&S SMB-K27) provides single and double pulse modulation with selectable pulse widths and periods or a user-definable pulse train.

See also [Chapter 5.5.1, "Overview of LF Generator"](#), on page 218.

External Modulation Sources

The modulation input MOD EXT at the instrument front provides the external modulation sources for amplitude, frequency and phase modulation.

The external audio signal for stereo modulation is input via the analog L and R inputs or via the digital S/P DIF interface at the rear of the instrument.

The external modulation signal for AM, FM and PM at the input must have a voltage of $U_S = 1 \text{ V}$ ($U_{EFF} = 0.707 \text{ V}$) in order to achieve the displayed modulation depth and range. The input voltage should not exceed 1 V, otherwise modulation distortions might occur.

The PULSE EXT connector at the rear of the instrument controls the external pulse modulation. The input shows some hysteresis with threshold levels of 0.5 V/1.5 V. The voltage must not exceed 5 V.

Simultaneous Operation of Several Modulations or Other Operating Modes

The table shows the modulations and operating modes which can be activated simultaneously (+) or which deactivate each other (-).

	AM	FM	PhiM	Pulse
Amplitude modulation (AM)	/	+	+	(+)
Frequency modulation (FM)	+	/	-	+
Phase modulation (PhiM)	+	-	/	+
Pulse modulation (Pulse)	(+)	+	+	/

5.4.2 Amplitude Modulation (AM)

An internal and/or external source can be selected for amplitude modulation. The LF modulation generator is available as the internal source.

Two-tone AM is possible by simultaneously switching on the external and internal source.

The MOD EXT input connector for external feed of analog modulation signals is at the front of the instrument. The coupling mode of the input (AC or DC) can be selected.

The AM modulation depth is limited by the maximum peak envelope power (PEP).

Exponential AM (Instruments with high frequency options)

Besides the linear amplitude modulation, whereby the signal voltage is proportional to the modulation signal, instruments equipped with the frequency options (R&S SMB-B112(L) /-B120(L) /-B140(L)) provide a level-proportional power or amplitude modulation.

In this case, the R&S SMB exponentially distorts the modulation signal, before it is output at the LF CONNECTOR - regardless of the [AM Source Int, or Ext](#) . The [AM Depth](#) is then indicated in dB.



Signal Sources for Exponential AM

You can perform exponential AM using either the internal, or an external modulation signal. However, in contrast to linear AM, the signal at the LF output connector is distorted in any operating mode. [AM Source Int+Ext](#) is not available.

5.4.2.1 Amplitude Modulation Settings

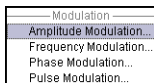

To open the "Amplitude Modulation" dialog, select "Modulation > Configure > Amplitude Modulation" or use the MENU key under "Modulation".

In the upper section of the dialog, the modulation source is selected and the modulation switched on. The modulation source can be selected independently for the different modulation types and the LF output.

The configuration of the selected external and/or internal modulation source is performed in the lower section of the dialog or in the "LF Output" dialog (internal source only).

These settings affect all modulations which use the same modulation source.

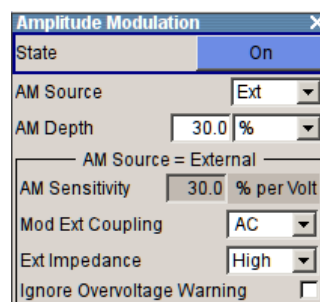

State

Activates amplitude modulation.

Remote command:

`[:SOURce<hw>] :AM:STATE` on page 328

AM Source

Selects the source for the AM modulation signal.

"Internal" Uses the internal LF generator as modulation signal source for AM.

- "External" Uses an externally applied modulation signal. The external signal is input via the MOD EXT connector.
- "Intern + Extern" Uses both, the internal and externally applied modulation signal, for example to perform two-tone AM.
Note: This setting applies to linear AM, see "[Exponential AM \(Instruments with high frequency options\)](#)" on page 199.

Remote command:

[:SOURce<hw>] :AM:SOURce on page 327

AM Type

Selects between linear or exponential (logarithmic) amplitude modulation, if you work with an instrument that is equipped with a 12 GHz, or higher frequency option.

Remote command:

[:SOURce<hw>] :AM:TYPE on page 328

AM Depth

Sets the modulation depth in percent.

Note: With two-tone modulation, observe that the set modulation depth applies to both signals and the sum modulation depth is determined by doubling the set modulation depth. This results in overmodulation if the maximal value for modulation depth is exceeded (see data sheet).

For instruments with frequency option 12 GHz or higher, you can additionally select [AM Type Exponential](#). In this case, the generator sets modulation depth in dB (logarithmic).

Modulation is possible both, upwards and downwards. Accordingly, the dynamic range extends for instruments without attenuator from minimum to maximum level. For instruments with attenuator, the dynamic range corresponds to the [Fixed Range \(PEP\) In](#); these are downwards about 20 dB, and upwards about 5 dB, that means in total about 25 dB around the set level.

Effects of positive/negative modulation depth:

- [AM Source Int](#)
 - positive depth -> downwards modulation
 - negative depth -> upwards modulation
- [AM Source Ext](#)
 - positive depth and negative external voltage -> downwards modulation
 - positive depth and positive external voltage -> upwards modulation
 - negative depth and negative external voltage -> upwards modulation
 - negative depth and positive external voltage -> downwards modulation

Remote command:

[:SOURce<hw>] :AM:DEPTH:LINear on page 326

[:SOURce<hw>] :AM:DEPTH:EXponential on page 325

LF Gen Freq

Sets the frequency of the LF generator.

This setting affects all analog modulations which use the LF generator as the internal modulation source.

Remote command:

[:SOURce] :LFOutput<ch> :FREQuency on page 349

LF Gen Shape

Selects the waveform shape of the LF signal.

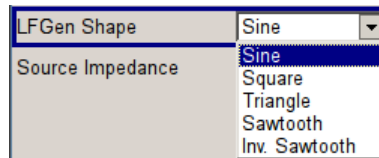

Note: The installed hardware determines the available settings. Use the [Hardware Config](#) dialog to check the hardware the instrument is equipped with.

For information on the required hardware revision, refer to the release notes.

Remote command:

[:SOURce] :LFOutput :SHAPE on page 357

AM Sensitivity

Displays the input sensitivity of the externally applied modulation signal at the MOD EXT input in %/V in [AM Type Linear](#) mode, and dB/V in [AM Type Exponential](#) mode.

The modulation depth entered under [AM Depth](#) is achieved with 1 Volt modulation of the input.

Remote command:

[:SOURce<hw>] :AM:SENSitivity? on page 327

AM External Coupling

Selects the coupling mode (AC or DC) for external feed.

Note: Coupling for external feed via input MOD EXT can be set independently for all modulations using the external modulation signal.

"AC" Disconnects the DC voltage component and uses only the AC component of the modulation signal.

"DC" Uses the modulation signal with both components, AC and DC.

Remote command:

[:SOURce<hw>] :AM:EXTernal:COUpling on page 326

Ext. Impedance

(Source "External" only)

Sets the impedance for the external modulation signal, applied at the MOD EXT connector.

You can select 600 Ohm or high (>100 kOhm).

This setting affects all analog modulations which use the external modulation signal.

Remote command:

[:SOURce<hw>] :INPut:MODext:IMPedance on page 347

Ignore Overvoltage Warning

Suppresses warnings the instrument generates when the modulation signal input is overloaded.

This function prevents a warning caused by signals, that generally comply with the specification, but temporarily overload the input, for example due to spikes. The warning is suppressed in the history, and in the error queue.

Note: This setting is not affected by an instrument preset (PRESET key), *rst or the Save/Recall function. Only the factory preset resets (enables) this setting.

Remote command:

[:SOURce<hw>] :INPut:MODExt:WIGNore on page 348

5.4.3 Frequency Modulation (FM)

An internal and/or external source can be selected for frequency modulation. The LF GEN modulation generator is available as the internal source. Two-tone FM is possible by simultaneously switching on the external and internal source.

The MOD EXT input connectors for external feed of analog modulation signals are at the front of the instrument. The coupling mode of the input (AC or DC) can be selected.

Selection between three modulation modes is possible:

- "Normal" mode with full setting range for modulation bandwidth and FM deviation.
- "Low Noise" mode with better signal/noise ratio, but reduced setting range for modulation bandwidth
- "High Deviation" mode with full setting range for FM deviation and a reduced setting range for modulation bandwidth (see data sheet).

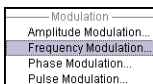

It is not possible to use frequency modulation simultaneously with phase modulation. See "[Simultaneous Operation of Several Modulations or Other Operating Modes](#)" on page 198 for an overview in detail.

5.4.3.1 Frequency Modulation Settings

To access the "Frequency Modulation" dialog, select "Modulation > Configure > Frequency Modulation" or use the MENU key under "Modulation".

In the upper section of the dialog, you can select the modulation source and activate modulation. The modulation source can be selected independently for the different modulation types and the LF output.

The configuration of the selected external and/or internal modulation source is performed in the lower section of the menu (internal source only).

These settings affect all modulations which use the same modulation sources.

State

Activates frequency modulation.

Activation of FM deactivates phase modulation.

Remote command:

[\[:SOURce<hw>\]:FM:STATE](#) on page 340

FM Source

Selects the source for the FM signal.

"Internal" Uses the internal LF generator as modulation signal source for FM.

"External" Uses an externally applied modulation signal.
The external signal is input via the MOD EXT connector.

"Internal + External" Uses both, the internal and externally applied modulation signal, for example to perform two-tone FM.

Remote command:

[\[:SOURce<hw>\]:FM:SOURce](#) on page 339

FM Mode

Selects the mode for the frequency modulation.

"Normal" The maximum range for modulation bandwidth and FM deviation is available.

"Low Noise" Frequency modulation with phase noise and spurious characteristics close to CW mode. The ranges of modulation bandwidth and FM deviation are reduced (see data sheet).

"High Deviation" Frequency modulation with full setting range for FM deviation. The range of modulation bandwidth is reduced (see data sheet).

Remote command:

[\[:SOURce<hw>\]:FM:MODE](#) on page 338

FM Deviation

Sets the modulation deviation in Hz.

The maximum deviation depends on the RF frequency and the modulation mode (see data sheet).

Note that you can set a deviation that is too high for a specific RF frequency, or set an RF frequency outside of the adjustable range of the deviation. In both cases, the instrument sets the maximum deviation and displays an error message.

In "Int + Ext" modulation source mode, the instrument divides the deviation into half for each source.

Remote command:

`[:SOURce<hw>] :FM[:DEVIation]` on page 337

`[:SOURce<hw>] :FM:INTernal:DEVIation` on page 338

`[:SOURce<hw>] :FM:EXTernal:DEVIation` on page 338

LF Gen Freq

Sets the frequency of the LF generator.

This setting affects all analog modulations which use the LF generator as the internal modulation source.

Remote command:

`[:SOURce] :LFOutput<ch>:FREQuency` on page 349

LF Gen Shape

Selects the waveform shape of the LF signal.

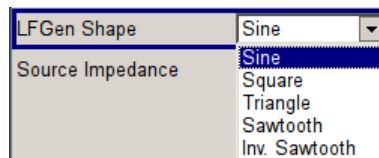

Note: The installed hardware determines the available settings. Use the [Hardware Config](#) dialog to check the hardware the instrument is equipped with.

For information on the required hardware revision, refer to the release notes.

Remote command:

`[:SOURce] :LFOutput:SHAPE` on page 357

FM Sensitivity

Displays the input sensitivity of the externally applied modulation signal at the MOD EXT input in Hz/V.

The modulation deviation entered with [FM Deviation](#) is achieved with 1 Volt (= U_{peak}) of the input signal.

Note: The input voltage must not exceed $1.1 V_p$ otherwise modulation distortions occur.

Remote command:

`[:SOURce<hw>] :FM:SENSitivity?` on page 339

Adjust FM Offset

Starts the adjustment for the FM/PhiM modulator. The option is adjusted concerning DC-offset.

Remote command:

[:CALibration<hw>:FMOffset\[:MEASure\]?](#) on page 286

FM External Coupling

(Source "External" only)

Selects the coupling mode (AC or DC) for the externally applied frequency modulation signal.

Note: Coupling for external feed via input MOD EXT can be set independently for all modulations using the external modulation signal.

"AC" Disconnects the DC voltage component and uses only the AC component of the modulation signal.

"DC" Uses the modulation signal with both components, AC and DC.

Remote command:

[\[:SOURce<hw>\]:FM:EXTernal:COUpling](#) on page 337

Ext. Impedance

(Source "External" only)

Sets the impedance for the external modulation signal, applied at the MOD EXT connector.

You can select 600 Ohm or high (>100 kOhm).

This setting affects all analog modulations which use the external modulation signal.

Remote command:

[\[:SOURce<hw>\]:INPut:MODext:IMPedance](#) on page 347

Ignore Overvoltage Warning

Suppresses warnings the instrument generates when the modulation signal input is overloaded.

This function prevents a warning caused by signals, that generally comply with the specification, but temporarily overload the input, for example due to spikes. The warning is suppressed in the history, and in the error queue.

Note: This setting is not affected by an instrument preset (PRESET key), *rst or the Save/Recall function. Only the factory preset resets (enables) this setting.

Remote command:

[\[:SOURce<hw>\]:INPut:MODext:WIGNore](#) on page 348

5.4.4 Phase Modulation (PhiM)



It is not possible to use phase modulation simultaneously with frequency modulation. See ["Simultaneous Operation of Several Modulations or Other Operating Modes"](#) on page 198 for an overview in detail.

An internal and/or external source can be selected for phase modulation. The LF GEN modulation generator is available as the internal source.

The MOD EXT input connector for external feed of analog modulation signals is at the front of the instrument. The coupling mode of the input (AC or DC) and the impedance can be selected.

Selection between the following modulation modes is possible:

- "Normal" mode with full setting range for modulation bandwidth and ϕ M deviation.
- "High Deviation" mode with full setting range for ϕ M deviation and a reduced setting range for modulation bandwidth. Phase noise is reduced in the lower modulation frequency range compared to the default mode.
- "Low Noise" mode with better signal/noise ratio, but reduced setting range for modulation bandwidth and deviation (see data sheet)

5.4.4.1 Phase Modulation Dialog

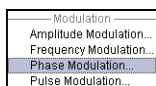

To open the "Phase Modulation" dialog, select "Modulation > Configure > Phase Modulation" or use the MENU key under "Modulation".

The Phase Modulation dialog box is titled "Phase Modulation" and has a close button (X) in the top right corner. The "State" is set to "On".

PhiM Source: Int+Ext (dropdown)

PhiM Mode: Normal (dropdown)

PhiM Deviation: 1.000 00 rad (dropdown)

PhiM Source = Internal:

- LFGen Freq: 1.000 00 kHz (dropdown)
- LFGen Shape: Sine (dropdown)

PhiM Source = External:

- PhiM Sensitivity: 0.500 00 rad per Volt (dropdown)
- Mod Ext Coupling: AC (dropdown)
- Ext Impedance: High (dropdown)
- Ignore Overvoltage Warning:

In the upper section of the dialog, the modulation source is selected and the modulation switched on. The modulation source can be selected independently for the different modulation types and the LF output.

The configuration of the selected external and/or internal modulation source is performed in the lower section of the dialog (internal source only).

These settings affect all modulations which use the same modulation sources.

An LF generator and a pulse generator are available as internal sources.

State

Activates ϕ M modulation.

Activation of ϕ M deactivates frequency modulation.

Remote command:

[:SOURce<hw>] :PM:STATe on page 376

ϕ M Source

Selects the source for the ϕ M signal.

"Internal" Uses the internal LF generator as the modulation signal source for ϕ M.

"External" Uses an externally applied modulation signal.
The external signal is input via the MOD EXT connector.

"Internal + External"
Uses both, the internal and externally applied modulation signal.

Remote command:

[:SOURce<hw>] :PM:SOURce on page 375

ϕ M Mode

Selects the mode for the phase modulation.

"Normal" The full range for modulation bandwidth and PM deviation is available.

"High Deviation" The maximum range for ϕ M deviation is available. Phase noise is improved for low frequencies compared to the default mode. The range of modulation frequency is limited (see data sheet). This mode is recommended for low modulation frequencies and/or high ϕ M deviation.

"Low Noise" Phase modulation with phase noise and spurious characteristics close to CW mode. The range for modulation bandwidth and PM deviation is limited (see data sheet).

Remote command:

[:SOURce<hw>] :PM:MODE on page 375

ϕ M Deviation

Sets the modulation deviation in RAD.

The maximum deviation depends on the set RF frequency and the selected modulation mode (see data sheet).

If the entered deviation is too high for the set RF frequency, the instrument provides the maximum value and displays an error message. The same applies, if the RF frequency is set to a value, at which the deviation cannot be determined.

The deviation of the internal source must not exceed the deviation of the external source in case of modulation source "Int+Ext".

Remote command:

`[:SOURce<hw>] :PM[:DEVIation]` on page 373

`[:SOURce<hw>] :PM:INTernal:DEVIation` on page 374

`[:SOURce<hw>] :PM:EXTernal:DEVIation` on page 374

LF Gen Freq

Sets the frequency of the LF generator.

This setting affects all analog modulations which use the LF generator as the internal modulation source.

Remote command:

`[:SOURce] :LFOutput<ch> :FREQuency` on page 349

LF Gen Shape

Selects the waveform shape of the LF signal.

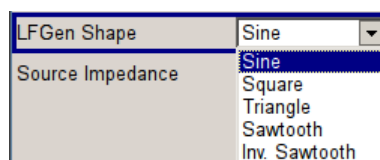

Note: The installed hardware determines the available settings. Use the [Hardware Config](#) dialog to check the hardware the instrument is equipped with.

For information on the required hardware revision, refer to the release notes.

Remote command:

`[:SOURce] :LFOutput :SHAPE` on page 357

ϕ M Sensitivity

Displays the input sensitivity of the externally applied modulation signal at the MOD EXT input in RAD/V.

The modulation deviation entered with [\$\phi\$ M Deviation](#) " ϕ M Deviation" is achieved with 1 Volt ($=U_{peak}$) of the input signal.

Note: The input voltage must not exceed 1.1 V_p otherwise modulation distortions occur.

Remote command:

`[:SOURce<hw>] :PM:SENSitivity?` on page 375

PhiM Ext Coupling

Selects the coupling mode ("AC" or "DC") for the external modulation signal.

Note: Coupling for external feed via input MOD EXT can be set independently for all modulations using the external modulation signal.

"AC" Disconnects the DC voltage component and uses only the AC component of the modulation signal.

"DC" Uses the modulation signal with both components, AC and DC.

Remote command:

`[:SOURce<hw>] :PM:EXTernal:COUpling` on page 373

Ext. Impedance

(Source "External" only)

Sets the impedance for the external modulation signal, applied at the MOD EXT connector.

You can select 600 Ohm or high (>100 kOhm).

This setting affects all analog modulations which use the external modulation signal.

Remote command:

`[:SOURce<hw>] :INPut:MODext:IMPedance` on page 347

Ignore Overvoltage Warning

Suppresses warnings the instrument generates when the modulation signal input is overloaded.

This function prevents a warning caused by signals, that generally comply with the specification, but temporarily overload the input, for example due to spikes. The warning is suppressed in the history, and in the error queue.

Note: This setting is not affected by an instrument preset (PRESET key), *rst or the Save/Recall function. Only the factory preset resets (enables) this setting.

Remote command:

`[:SOURce<hw>] :INPut:MODext:WIGNore` on page 348

5.4.5 Pulse Modulation (PM)

The available options for performing pulse modulation include:

- option Pulse Modulator (R&S SMB-K22)
- option Pulse Generator (R&S SMB-K23) , comprises "Single" and "Double" pulse generation
- option Pulse Train (R&S SMB-K27), enables generation of pulse trains.

As modulation signal, you can either use the signal of the internal pulse generator or an externally supplied signal. In case of external source, the external signal is input via the PULSE EXT connector at the rear of the instrument. In case of internal source, this connector can be used as external trigger or gate signal input for internal pulse modulation. The polarity and input impedance of the connector can be selected.

The pulse signal is output at the PULSE VIDEO connector at the rear of the instrument.



Automatic Level Control is deactivated with pulse modulation!

When pulse modulation is activated, the R&S SMB deactivates ALC automatically ("ALC OFF", i.e. switches to "Sample & Hold" state).

The "Sample&Hold" state opens the ALC loop, and disables the automatic control of the output level. The level modulator is set directly.

However, to correct the output level, the R&S SMB executes a "Sample & Hold" measurement after each change of frequency or level settings.

The level is decreased by 30 dB during "Sample & Hold" measurement.

5.4.5.1 Pulse Modulation Settings

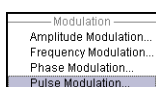

- ▶ To access the "Pulse Modulation" settings, select "Modulation > config... > Pulse Modulation".

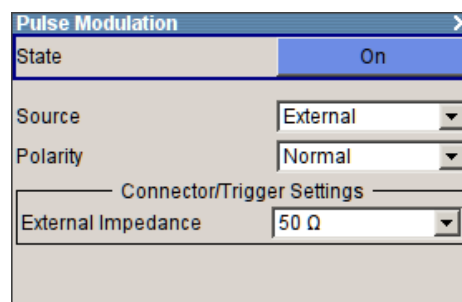
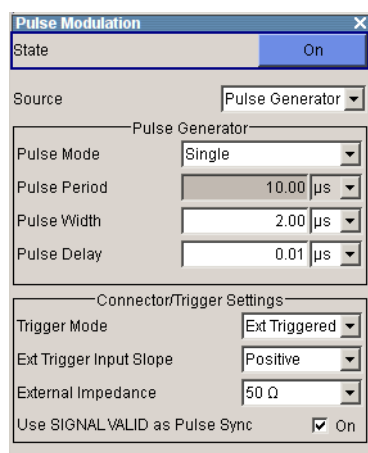

The dialog contains all parameters for configuring a pulse modulation signal, comprising the signal source, pulse generator and trigger settings.

Depending on the selected modulation source, the provided parameters vary:

- "Source Pulse Generator"
 - Displays the parameters for configuring the pulse generator signal, which in turn vary according to the selected "Mode > Single / Double ...".
 - Note:** Extended features as the generation of double pulse signals or selectable trigger mode require option R&S SMB-K23.
- "External"
 - Enables you to configure the polarity of an externally supplied pulse modulation signal.

Additionally, you can use the internally generated *Valid Signal* for synchronization of the pulse modulation, and assign this signal to the VALID SIGNAL connector, see [Chapter 5.5.4.1, "Pulse Generator Settings"](#), on page 226 for description.

Note: The pulse generator settings in this dialog are mirrored from the actual "Pulse Generator" dialog of the "Mod Gen" block. Therefore find the description on the access

and the corresponding parameters under in [Chapter 5.5.4.1, "Pulse Generator Settings"](#), on page 226.

Option R&S SMB-K27 enables the generation of pulse trains. For description of the pulse train dialog, see [Chapter 5.5.4.2, "Pulse Train Generation"](#), on page 230.

State

Activates pulse modulation.

When the internal modulation source (pulse generator) is selected, the pulse generator is switched on automatically and the video/sync signal is output at the PULSE VIDEO output at the rear of the instrument. Signal output can be switched off in the "Pulse Generator" dialog (see [Chapter 5.5.4, "Pulse Generator"](#), on page 226).

Remote command:

`[:SOURce<hw>] :PULM:STATe` on page 394

Source

Selects the modulation signal source for pulse modulation.

"Pulse Generator"

Uses the pulse generator as modulation signal source.

Uses the internally generated rectangular signal pulse modulation.

"External"

Uses an externally applied modulation signal.

The external modulation signal is input via the PULSE EXT connector.

Remote command:

`[:SOURce<hw>] :PULM:SOURce` on page 393

Polarity

(External Source only)

Selects the polarity of the modulation signal.

"Normal" The RF signal is **On** while the level is high at the modulation input.

"Inverse" The RF level is **Off** if the level is high at the modulation input.

Remote command:

`[:SOURce<hw>] :PULM:POLarity` on page 393

5.4.6 Stereo Modulation

Options R&S SMB-B5, Stereo/RDS Coder enables generation of stereo-modulated RF signals according to standard. Beside the MPX (FM stereo multiplex) signal, also the radio traffic service ARI (Automotive Radio Information) and Radio Data System (RDS) are supported by the option.

An internal or external source can be selected for the audio signal of the stereo modulation. In case of external source, the external signal is input via the analog L and R inputs or via the digital S/P DIF interface at the rear of the instrument. In case of internal source, the LF generator is used. Measurements can be performed in the operating modes L and R, and $L = R$, $L = -R$ and $R \neq L$ (ext. signals only).

A typical setup with the R&S SMB with the option Stereo/RDS Coder in connection with the Audio Analyzer UPV is shown in the following graph.

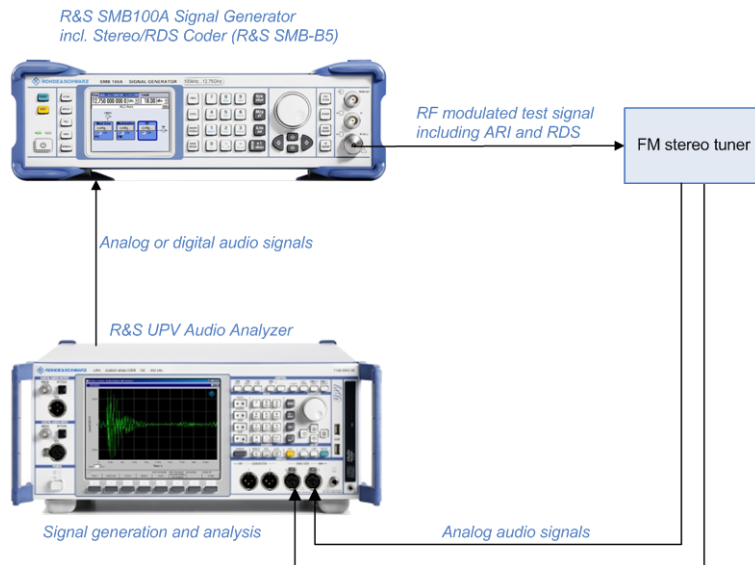

5.4.6.1 Stereo Modulation Dialog

To open the "Stereo Modulation" dialog, select "Modulation > Configure > Stereo Modulation" or use the MENU key under "Modulation".



In the upper section of the menu, the stereo modulation is configured and switched on. The configuration and activation of the additional pilot tone, ARI and RDS settings is performed in the lower section of the dialog.

State	On
FM Deviation	40.000 kHz
Audio Source	Ext L,R
Mode	Mono Left
Ext R,L Impedance	100 kOhm
Preemphasis	50 µs
Max Modulation Freq	1.000 kHz
Stereo Pilot Tone Settings	
Pilot State	On
Pilot Deviation	6.750 kHz
Pilot Phase	0.0 deg
ARI Settings	
ARI State	Off
ARI Deviation	3.500 kHz
ARI Identification	Off
ARI BK	A
RDS Settings	
RDS State	On
RDS Deviation	2.000 kHz
RDS Data Set	DS1
Program Service Name	
Program Identification	
Traffic Program	On
Traffic Announcement	On
Stereo Coder	
Adjustment Data	Factory

General Settings

State - Stereo Modulation

Activates/deactivates stereo modulation.

Remote command:

[\[:SOURCE\]:STEREO:STATE](#) on page 416

FM Deviation - Stereo Modulation

Sets the MPX (Multiplex stereo signal) deviation.

Remote command:

[\[:SOURCE\]:STEREO\[:DEVIATION\]](#) on page 417

Audio Source - Stereo Modulation

Selects the source for the audio signal.

- | | |
|----------------|--|
| "Off" | No audio signal is provided, ARI and RDS signal can be generated separately. |
| "Ext L,R" | The external audio stereo signal is feed in via the analog L and R inputs. |
| "Ext S/P Diff" | The external audio signal is feed in via the digital S/P DIF input. |
| "LF Gen" | The audio stereo signal is internally generated by the LF generator. |

Remote command:

[\[:SOURCE\]:STEREO:SOURCE](#) on page 416

Mode - Stereo Modulation

Selects the mode for the audio signal. If the internal LF generator is selected as audio source, the signal is generated according to the selection here. For external signals, the signal type has to be entered.

"Mono Left"	A mono signal containing the left channel is generated/fed in.
"Mono Right"	A mono signal containing the right channel is generated/fed in.
"Stereo R=L"	A stereo signal with right and left channel is generated/fed in. The channels have the same frequency and phase.
"Stereo R=-L"	The signal on the left external audio input is used for both channels, left and right. The right channel is inverted.
"Stereo R! =L"	(External source only) A stereo signal containing different, independent right and left channels is fed in. It is possible, for example, to feed a fixed audio frequency to the first channel while a frequency sweep is being performed in the second channel.

Remote command:

[\[:SOURCE\]:STEReo:AUDio:MODE](#) on page 410

LF Gen Freq - Stereo Modulation

(Audio source "LF Gen" only)

Sets the frequency of the LF generator signal.

This setting affects all analog modulations which use the LF generator as the internal modulation source.

Remote command:

(two alias commands are available)

[\[:SOURCE\]:STEReo:AUDio\[:FREQuency\]](#) on page 412

[\[:SOURCE\]:LFOutput<ch>:FREQuency](#) on page 349

LF Gen Shape - Stereo Modulation

(Audio source "LF Gen" only)

Selects the shape of the LF generator signal.

This setting affects all analog modulations which use the LF generator as the internal modulation source.

Remote command:

[\[:SOURCE\]:LFOutput:SHAPE](#) on page 357

External R/L Impedance - Stereo Modulation

(External analog audio signal input only)

Selects the input impedance for the external analog audio signal inputs L and R.

Remote command:

[\[:SOURCE\]:STEReo:EXTernal:IMPedance](#) on page 413

Preemphasis - Stereo Modulation

Activates and sets the pre-emphasis used for signal generation.

Remote command:

[\[:SOURCE\]:STEReo:AUDio:PREemphasis:STATE](#) on page 412

[\[:SOURCE\]:STEReo:AUDio:PREemphasis](#) on page 411

Max Modulation Freq- Stereo Modulation

Sets the maximum modulation frequency that may be used.

This parameter is valid/required only when pre-emphasis has been activated and an external modulation source is used.

Pre-emphasis increases the high-frequency portions of the signal in the level before the FM modulator is reached. This can lead to internal overload of the modulator in the case of sinewave signals with full modulation. The MMF parameter is used to reduce the internal full modulation to such an extent that sinewave signals with nominal voltage can be transmitted with low distortion at the stereo input even when pre-emphasis up to the set frequency has been activated. However, this reduces the S/N ratio on the basis of the increase in level by the pre-emphasis (at the MMF that has been set).

In the case of normal modulation signals such as voice or music, this parameter can be left at its default value because the amplitude of the high-frequency portions of these signals normally decreases substantially.

Remote command:

[\[:SOURCE\]:STEReo:MMF](#) on page 413

Stereo Pilot Tone Settings

The 19 kHz pilot tone is configured in the "Stereo Pilot Tone Settings" section.

Pilot State - Stereo Modulation

Activates/deactivates the pilot tone generation.

Remote command:

[\[:SOURCE\]:STEReo:PILot:STATE](#) on page 414

Pilot Deviation - Stereo Modulation

Sets the deviation of the pilot tone.

Remote command:

[\[:SOURCE\]:STEReo:PILot\[:DEVIation\]](#) on page 414

Pilot Phase - Stereo Modulation

Sets the phase of the pilot tone in relation to the 38 kHz carrier signal of the receiver. For a correct demodulation, the pilot tone must be in phase with the 38 kHz carrier.

Remote command:

[\[:SOURCE\]:STEReo:PILot:PHASe](#) on page 413

ARI Settings

The radio traffic service ARI (Automotive Radio Information) is configured in the "ARI Settings" section.

ARI State - Stereo Modulation

Activates/deactivates the ARI signal generation. ARI signals can be generated simultaneously with MPX and RDS signals.

Remote command:

[:SOURce] :STEReo:ARI:STATe on page 409

ARI Deviation - Stereo Modulation

Sets the frequency deviation of the ARI subcarrier signal.

Remote command:

[:SOURce] :STEReo:ARI[:DEViation] on page 410

ARI Identification - Stereo Modulation

Selects the generated identifiers of the ARI signal.

"Off"	Only the 57 kHz subcarrier is generated (Senderkennung). It marks the stations which broadcast traffic programs and enables the receiver to recognize the frequency as being ARI-capable.
"DK"	The message identification (Durchsagekennung) is generated in addition (low-frequency 30% AM). It signalizes that a traffic message is currently broadcasted.
"BK"	The area identification (Bereichskennung) is generated in addition (60% AM). This code is used to identify the geographical region covered by the radio station. The specific code is selected below.
"DK+BK"	The area and message identification are generated in addition.

Remote command:

[:SOURce] :STEReo:ARI:TYPE on page 409

ARI BK - Stereo Modulation

Selects the specific area identification (BK) code of the ARI signal. The six letters (six different frequencies) identify a specific region in each country.

Remote command:

[:SOURce] :STEReo:ARI:BK[:CODE] on page 408

RDS Settings

The RDS (Radio Data System) is configured in the RDS Settings section, RDS is a communications protocol standard from the European Broadcasting Union for sending digital information embedded in conventional FM radio broadcasts. The RDS system standardises several types of transmitted information, including time, track/artist info and station identification.

RDS State - Stereo Modulation

Activates/deactivates the RDS signal generation. RDS signals can be generated simultaneously with MPX and ARI signals.

Remote command:

[:SOURce] :STEReo:RDS:STATe on page 414

RDS Deviation - Stereo Modulation

Sets the deviation of the RDS subcarrier.

Remote command:

[\[:SOURCE\]:STEReo:RDS\[:DEVIation\]](#) on page 415

RDS Data Set - Stereo Modulation

Selects the data set used in the RDS signal. Five data sets are provided on the instrument. The values of the data sets can be defined via remote control (command `SOURce:STEReo:DIRect`)

Each of these data sets contains predefined values for:

- PI (program identification, identifies the broadcast station)
- PS or scrolling PS (program service name, represents the station identity name)
- TP (traffic program, mark stations with regular traffic programs)
- TA (traffic announcement, marks the start of a traffic program)
- PTY (program type, predefined genres of broadcasting programs, e.g. news)
- PTYN (program type name)
- DI (decoder information)
- MS (music /speech)
- CT (clock time, used for synchronization)

The following values are empty:

- RT (radio text, two text blocks with 64 symbols each)
- AF (alternative frequencies, maximum of five lists with 25 frequencies each, enables the receiver to re-tune to a different frequency providing the same station when the first signal becomes too weak)
- TMC (traffic message channel)
- EON (enhanced other networks, eight PS with five EON AF lists each, enables the receiver to automatically tune into these stations if a traffic programs are broadcasted)

The program identification and the program service name of the selected data set are indicated in the menu.

Remote command:

[\[:SOURCE\]:STEReo:RDS:DATaset](#) on page 414

RDS Program Service Name - Stereo Modulation

Indicates the RDS program service name.

Remote command:

[\[:SOURCE\]:STEReo:DIRect](#) on page 412

RDS Program Identification - Stereo Modulation

Indicates the RDS program identification.

Remote command:

[\[:SOURCE\]:STEReo:DIRect](#) on page 412

RDS Traffic Program State - Stereo Modulation

Activates the RDS traffic program (TP function). The receiver can recognize a frequency as being capable of traffic information only if the TP function is active.

Remote command:

[\[:SOURce\]:STEReo:RDS:TRAFfic:PROGram\[:STATe\]](#) on page 415

RDS Traffic Announcement State - Stereo Modulation

Activates the RDS traffic announcement (TA function). If activated, the receiver switches from the current status, e.g. playing a CD, to the receive mode and enables the broadcast of a traffic announcement. The TP state has to be on.

Remote command:

[\[:SOURce\]:STEReo:RDS:TRAFfic:ANNouncement\[:STATe\]](#) on page 415

Adjustment Data

Indicates the adjustment state of the analog channels of the stereo coder. For the adjustment of the S/P DIF see service manual, chapter 2, "Adjustment".

See also "[Adjust Stereo Coder](#)" on page 94.

5.5 Modulation Generator and LF Output

5.5.1 Overview of LF Generator

The internal modulation generator of the instrument provides a sinusoidal or rectangular LF modulation signal without additional equipment options. The corresponding key data, as for example the frequency range, is specified under "Modulation sources" in the data sheet.

You can use the internal LF signal as modulation signal source for the analog modulations, as for example the amplitude modulation. The signal applies to all modulations which are using the internal modulation signal. Therefore, any modification of the LF signal impacts all currently active modulations immediately.

To configure the LF generator signal, see [Chapter 5.5.2.1, "LF Output Dialog"](#), on page 219. However, you can also configure the LF signal directly in the settings dialogs of the analog modulations.

Optionally, the instrument provides the following modulation sources:

- Pulse Generator (option R&S SMB-K23) for generating single and double pulse signals, see [Chapter 5.5.4, "Pulse Generator"](#), on page 226.
- High-performance pulse generator (option R&S SMB-K27) for generating pulse train signals.

The R&S SMB also provides the configured LF signal at the corresponding output connector, for example as modulation signal source for interconnected instruments.

5.5.2 LF Output

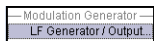

- ▶ To open the "LF Generator / Output" dialog, select "Mod Gen > Configure > LF Generator / Output" or use the MENU key under "Mod Gen".

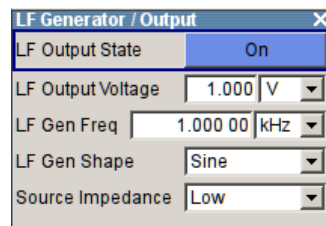

The dialog provides access to the configuration of the internal modulation generators, and you can activate the output of the LF signal. The available settings depend on the source selected and on the installed options. Alternatively, you can perform the settings also in the corresponding dialogs of the analog modulations, like "Amplitude Modulation". The configured LF signal applies to all modulations which use the internal modulation sources, and to the LF output.



AM Exponential (Instruments with 12, 20, or 40 GHz frequency options)

If you perform exponential AM ([AM Type Exponential](#)) with the internal signal of the LF generator, the LF output provides the exponential modulation signal.

Using [AM Source External](#), the instrument supplies the distorted external signal. The signal of the internal modulation generator is not available, as well as setting the parameters [LF Gen Freq](#) and ["LF Gen Shape"](#) on page 201.

The remote commands required to define these settings are described in [Chapter 7.13.6, "SOURCE:LFOutput Subsystem"](#), on page 348.

5.5.2.1 LF Output Dialog

LF Output State

Activates the LF output. This setting has no effect on the modulations.

The modulation signal is output at the LF OUTPUT connector of the instrument.

Remote command:

`[:SOURCE] :LFOutput [:STATe]` on page 352

LF Output Voltage

Sets the voltage (peak) of the LF output signal.

Remote command:

`[:SOURCE] :LFOutput :VOLTagE` on page 358

LF Gen Freq

Sets the frequency of the LF generator.

This setting affects all analog modulations which use the LF generator as the internal modulation source.

Remote command:

[:SOURce] :LFOutput<ch> :FREQuency on page 349

LF Gen Shape

Selects the waveform shape of the LF signal.

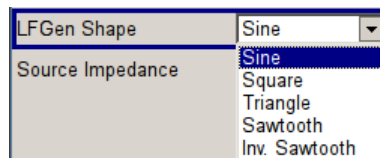

Note: The installed hardware determines the available settings. Use the [Hardware Config](#) dialog to check the hardware the instrument is equipped with.

For information on the required hardware revision, refer to the release notes.

Remote command:

[:SOURce] :LFOutput :SHAPE on page 357

LF Source Impedance

Selects the output impedance of the LF generator. Selection LOW and 600 Ohm are available.

Note: The installed hardware determines the available settings. Use the [Hardware Config](#) dialog to check the hardware the instrument is equipped with.

For information on the required hardware revision, refer to the release notes.

Remote command:

[:SOURce] :LFOutput :SIMPedance on page 358

5.5.3 LF Frequency Sweep

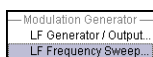

The "LF Frequency Sweep" dialog is used to configure and activate an LF frequency sweep signal.

To open the "LF Frequency Sweep" dialog, select "Mod Gen > Configure > LF Frequency Sweep" or use the MENU key under "Mod Gen".

The LF sweep mode is activated and the sweep mode is selected. The buttons are used to reset the LF sweep (all sweep modes) or to execute the LF sweep ("Single" mode).

The sweep range, sweep spacing and dwell time are set in the bottom of the section.

LF Frequency Sweep	
State	On
Mode	Auto
Reset Sweep	
Start Freq	1.000 0 kHz
Stop Freq	50.000 0 kHz
Current Freq	41.000 0 kHz
Spacing	Linear
Shape	Sawtooth
Step Lin	1.000 0 kHz
Dwell Time	10.0 ms

State

Activates the LF frequency sweep signal generation.

Note:

Activating a sweep mode automatically deactivates other sweeps and the list mode.

Remote command:

[\[:SOURce<hw>\]:LFOutput:FREQUENCY:MODE](#) on page 350

Mode

Selects the LF frequency sweep mode.

If you change the sweep mode during the execution, the signal generator stops the sweep and starts with the next trigger event at the initial value.

The "Reset Sweep" button sets the sweep to the start value.

"Auto" Generates a continuously repeating sweep signal immediately after activating the sweep mode.
The sweep steps are performed automatically, controlled by the dwell time, see ["Dwell Time - LF Sweep"](#) on page 225.

Example:

```
SOUR:LFO:SWE:FREQ:MODE AUTO
TRIG0:SWE:SOUR AUTO
SOUR:LFO:FREQ:MODE SWE
```

"Single" Generates a single sweep cycle after a trigger event. The sweep steps within the cycle are performed automatically, controlled by the dwell time. If one cycle is completed, the instrument waits for the next trigger event. To trigger the sweep, use "Execute Single Sweep" button, or the corresponding remote control commands, for example *TRG.

Example:

```
SOUR:LFO:SWE:FREQ:MODE AUTO
TRIG0:SWE:SOUR SING
SOUR:LFO:FREQ:MODE SWE
SOUR:LFO:SWE:FREQ:EXEC
```

"Step" Generates the sweep signal step-by-step, manually triggered. To perform the sweep steps, enter the frequency value under [Current Freq.](#)

Example:

```
SOUR:LFO:SWE:FREQ:MODE MAN
SOUR:LFO:FREQ:MODE SWE
SOUR:LFO:SWE:FREQ:SPAC LIN
SOUR:LFO:SWE:FREQ:STEP:LIN 1E34
SOUR:LFO:FREQ:MAN 12 kHz
```

The value entered with command

`SOUR:LFO:SWE:FREQ:STEP:LIN|LOG` sets the step width.

The value entered with command `SOUR:LFO:FREQ:MAN` has no effect, the command only sets the next sweep step. In remote control only a step-by-step sweep from start to stop frequency is possible.

"Extern Single"

Generates a single sweep cycle when an external trigger event occurs.

The sweep steps within the cycle are performed automatically, controlled by the dwell time. If one cycle is completed, the instrument waits for the next trigger event.

To trigger the sweep, apply an external trigger signal.

Refer to the description of the rear panel for information on the connectors for external trigger signal input (see [Chapter 2.2, "Rear Panel Tour"](#), on page 21).

Example:

```
SOUR:LFO:SWE:FREQ:MODE AUTO
TRIG0:SWE:SOUR EXT
SOUR:LFO:FREQ:MODE SWE (External trigger)
```

"Extern Step" Generates the sweep signal step-by-step, manually triggered. To trigger a sweep step, apply an external trigger signal. The step width corresponds to the step width set for the rotary knob.

Example:

```
SOUR:LFO:SWE:FREQ:MODE AUTO
TRIG0:SWE:SOUR EXT
SOUR:LFO:FREQ:MODE SWE (External trigger)
```

"Extern Start/Stop" Generates a continuously repeating sweep signal that is started, stopped and restarted by subsequent external trigger events. The sweep steps are performed automatically, controlled by the dwell time. Refer to the description of the rear panel for information on the connectors for the external trigger signal input (see [Chapter 2.2, "Rear Panel Tour"](#), on page 21).

Example:

```
SOUR:LFO:SWE:FREQ:MODE AUTO
TRIG0:SWE:SOUR EAUT
SOUR:LFO:FREQ:MODE SWE (External trigger)
```

Remote command:

```
[ :SOURce<hw> ] :LFOutput :SWEep [ :FREQuency ] :MODE on page 353
:TRIGger<hw> [ :SWEep ] :SOURce on page 454
[ :SOURce<hw> ] :LFOutput :FREQuency :MODE on page 350
```

Execute Single Sweep

Starts a sweep manually. This trigger button is displayed in "Single" mode.

Example:

```
SOUR:LFO:SWE:FREQ:MODE AUTO
TRIG:LFFS:SWE:SOUR SING
TRIG:LFFS
```

Remote command:

```
[ :SOURce<hw> ] :LFOutput :SWEep [ :FREQuency ] :EXECute on page 352
:TRIGger<hw> :LFFSweep :IMMediate on page 452
:TRIGger<hw> :LFFSweep on page 452
:TRIGger<hw> [ :IMMediate ] on page 455
```

Reset Sweep

Resets a sweep.

With the next trigger event, the sweep starts with at the initial value.

Remote command:

```
[ :SOURce<hw> ] :SWEep :RESet [ :ALL ] on page 429
```

Start Freq

Sets the start frequency.

Remote command:

`[:SOURce<hw>] :LFOutput:FREQuency:STARt` on page 351

Stop Freq

Sets the stop frequency.

Remote command:

`[:SOURce<hw>] :LFOutput:FREQuency:STOP` on page 351

Current Freq

Displays the current frequency.

In sweep "Step" mode, the parameter is editable and you can enter frequency for the next step.

Remote command:

`[:SOURce<hw>] :LFOutput:FREQuency:MANual` on page 350

Spacing

Selects the mode for the calculation of the frequency sweep intervals.

"Linear" Takes the frequency value entered as an absolute value in Hz

"Logarithmic" Takes the value entered as a logarithmic value, that means as a constant fraction of the current frequency in %.

Remote command:

`[:SOURce<hw>] :LFOutput:SWEep[:FREQuency]:SPACing` on page 355

Shape

Selects the waveform shape of the sweep signal.

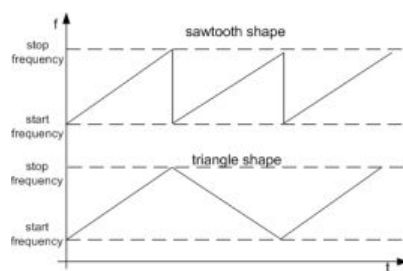

"Sawtooth" The sweep runs from the start to the stop frequency. Each subsequent sweep starts at the start frequency, that means the shape of the sweep sequence resembles a sawtooth.

"Triangle" The sweep runs from start to stop frequency and back, that means the shape of the sweep resembles a triangle. A subsequent sweep starts at the start frequency.

Remote command:

`[:SOURce<hw>] :LFOutput:SWEep[:FREQuency]:SHAPE` on page 355

Retrace - LF Frequency Sweep

Activates that the signal changes to the start frequency value while it is waiting for the next trigger event.

You can enable this feature, when you are working with sawtooth shapes in sweep mode "Single" or "External Single", see [Mode](#).

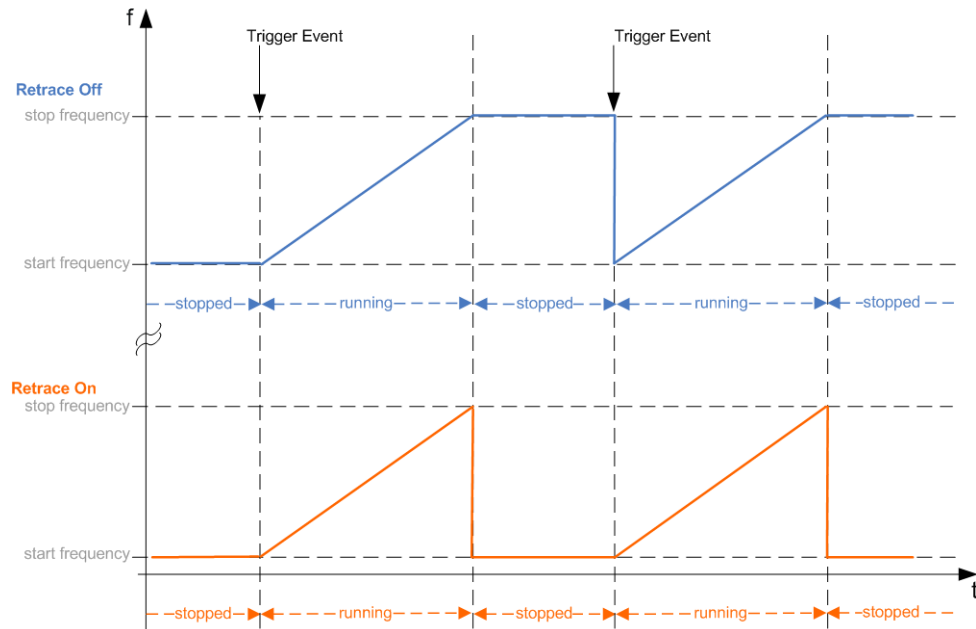

Remote command:

`[:SOURce<hw>] :LFOutput :SWEep [:FREQuency] :RETRace` on page 354

Step Lin/Log - LF Sweep

Sets the step width for the individual frequency sweep steps.

At each step this value is added to the current frequency.

Depending on the [Spacing](#) mode you have set, the corresponding parameter is displayed.

"Step Lin" The step width is a constant value in Hz.

Remote command:

`[:SOURce<hw>] :LFOutput :SWEep [:FREQuency] :STEP [:LINear]` on page 356

"Step Log" The step width is determined logarithmically in %, that means as a constant fraction of the current frequency.

Remote command:

`[:SOURce<hw>] :LFOutput :SWEep [:FREQuency] :STEP :LOGarithmic`
on page 357

Dwell Time - LF Sweep

Defines the duration of the individual sweep steps.

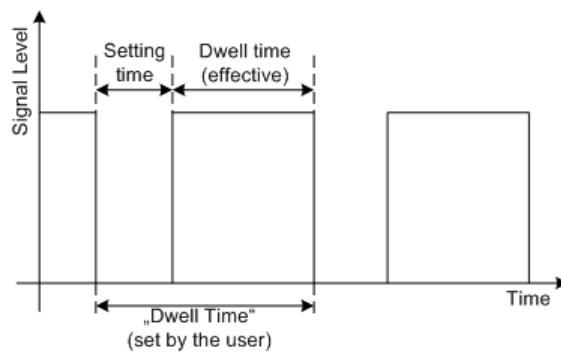

The "Dwell Time" set by the user is used as the step time of the sweep. The effective net dwell time is shorter, reduced by the setting time. This setting time may be greater than the time specified in the data sheet.

Note:

It is recommended to switch off the display update for optimum sweep performance especially with short dwell times (see [Chapter 5.2.3.7, "Display Update"](#), on page 100).

Remote command:

`[:SOURce<hw>] :LFOutput :SWEep [:FREQuency] :DWELL` on page 352

Ext. Trigger Input Slope

Sets the polarity of the active slope of an externally applied instrument trigger.

This setting affects the INST TRIG input (BNC connector at the rear of the instrument).

"Positive" activates the rising edge of the trigger signal.

"Negative" activates the falling edge of the trigger signal.

Remote command:

`[:SOURce] :INPut :TRIGger :SLOPe` on page 348

5.5.4 Pulse Generator

The "Pulse Generator" dialog is used to configure and activate a pulse modulation signal.

5.5.4.1 Pulse Generator Settings

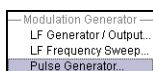

To access the pulse generator settings ...

- ▶ Select "Mod Gen > config... > Pulse Generator" or use the MENU key under "Mod Gen".

Alternatively, the R&S SMB provides the pulse generator parameters in the "Pulse Modulation" dialog accessed via the "Modulation" block.

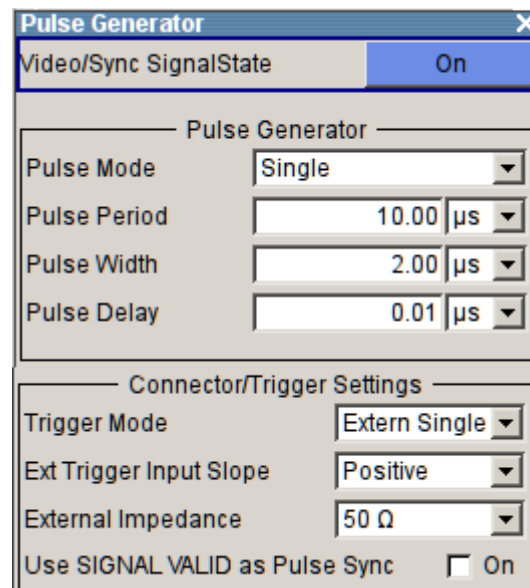

The dialog provides the settings for the pulse characteristics and trigger mode. Depending on the selected modulation source and pulse mode the provided parameters vary.

Note: Extended features as the generation of double pulse signals with selectable pulse widths and periods, or selectable trigger mode require option R&S SMB-K23.

Video Sync Signal State - Pulse Generator

Switches on/off the output of the video/sync signal at the PULSE VIDEO connector. The signal output and the pulse generator are automatically switched on with activation of pulse modulation if pulse generator is selected as modulation source. The signal output can be switched off subsequently.

Pulse modulation of the RF carrier is activated in the "Pulse modulation" menu of the "Modulation" block.

Remote command:

[\[:SOURce<hw>\]:PGENerator:STATe](#) on page 372

Pulse Mode - Pulse Generator

Sets the mode of the pulse generator.

- | | |
|----------|---|
| "Single" | A single pulse is generated in one pulse period. |
| "Double" | Two pulses are generated in one pulse period. Additional settings for the double pulse are available in the menu. |
| "Train" | Requires option R&S SMB-K27.
A user-defined pulse train is generated. Additional settings for the pulse train are available in the menu after selection of the pulse train mode (see Chapter 5.5.4.2, "Pulse Train Generation" , on page 230). A pulse train is a sequence of pulses with user-defined on and off times. The on-time/off-time value pairs are defined in a pulse train list. The currently used pulse train file is displayed in the sub menu. |

Remote command:

[:SOURce<hw>] :PULM:MODE on page 391

Pulse Period - Pulse Generator

Sets the period of the generated pulse. The period determines the repetition frequency of the internal signal.

Remote command:

[:SOURce<hw>] :PULM:PERiod on page 392

Pulse Width - Pulse Generator

Sets the width of the generated pulse. The width determines the pulse length. The pulse width must be at least 20 ns less than the set pulse period.

Remote command:

[:SOURce<hw>] :PULM:WIDTh on page 404

Pulse Delay - Pulse Generator

(External trigger only)

Sets the pulse delay. The pulse delay determines the time that elapses after a trigger event before pulse modulation starts. The pulse delay is not effective for double pulse generation.

Remote command:

[:SOURce<hw>] :PULM:DELay on page 390

Double Pulse Width - Pulse Generator

(Double Pulse only)

Sets the width of the second pulse.

Remote command:

[:SOURce<hw>] :PULM:DOUBle:WIDTh on page 391

Double Pulse Delay - Pulse Generator

(Double Pulse only)

Sets the delay from the start of the first pulse to the start of the second pulse.

Remote command:

[:SOURce<hw>] :PULM:DOUBle:DELay on page 391

Trigger Mode - Pulse Generator

Selects the trigger mode for pulse modulation.

Note: An external trigger signal is supplied via the PULSE EXT connector.

"Auto"

The pulse generator signal is generated continuously.

"Single"

The pulse generator signal is triggered by an internal trigger event, initiated with the "Execute Single Trigger" on page 229.

"Extern Single"

The pulse modulation is triggered by an external trigger event.

"Extern Gated"

The pulse generator signal is gated by an external gate signal.

Remote command:

[\[:SOURce<hw>\]:PULM:TRIGger:MODE](#) on page 399

Execute Single Trigger

Initiates a single pulse sequence manually.

This function is enabled in "Single Trigger", see [Trigger Mode - Pulse Generator](#)

Remote command:

[\[:SOURce\]:PULM\[:INTernal\]\[:TRAIIn\]:TRIGger:IMMediate](#) on page 400

*[TRG](#) on page 283

External Trigger Input Slope - Pulse Generator

(External Trigger only)

Sets the polarity of the active slope of an applied trigger signal.

"Positive" The pulse generator is triggered on the positive slope of the external trigger signal.

"Negative" The pulse generator is triggered on the negative slope of the external trigger signal.

Remote command:

[\[:SOURce<hw>\]:PULM:TRIGger:EXTernal:SLOPe](#) on page 399

Gate Input Polarity - Pulse Generator

(Trigger Mode External Gated only)

Selects the polarity of the Gate signal.

The signal is supplied via the PULSE EXT connector.

"Normal" The pulse signal is generated while the gate signal is high.

"Inverse" The pulse signal is generated while the gate signal is low.

Remote command:

[\[:SOURce<hw>\]:PULM:TRIGger:EXTernal:GATE:POLarity](#) on page 398

External Impedance

Selects the input impedance (10 kOhm or 50 Ohm) for the external trigger and gate signal input (PULSE EXT).

Remote command:

[\[:SOURce<hw>\]:PULM:TRIGger:EXTernal:IMPedance](#) on page 399

Use SIGNAL VALID as Pulse Sync

Configures the signal at the SIGNAL VALID connector (rear panel):

"selected" Indicates the validity of the RF signal at the output:

- **high:** while the signal settles.
- **low:** when it is stable (valid).

"cleared" Generates a single pulse at the beginning of a pulse sequence, e.g. to synchronize pulse modulation.

Remote command:

[:SOURce<hw>] :PULM:OUTPut:SYNC [:STATe] on page 392

5.5.4.2 Pulse Train Generation

In "Pulse Train" mode, the instrument provides the associated parameters for configuring a user-defined pulse train signal.

A pulse train is a sequence of pulses with user-defined on and off times. The "ON Time / OFF Time" value pairs are defined in a pulse train table and can be stored in a file. The currently loaded file is displayed in the dialog. You can export an internally created pulse train list as well as import an externally created one.



In remote control mode, you must first create a data file, before you switch to pulse train mode. Otherwise you get the error message "No current list" in the "Info" line, see [Example "Generating a pulse train signal"](#) on page 389.

How to configure a pulse train signal

To perform pulse train generation, perform the following steps:

1. In the block diagram, select "Modulation > config... > Pulse Modulation".
2. Select "Source > Pulse Generator".
3. Select "Pulse Mode > Train".

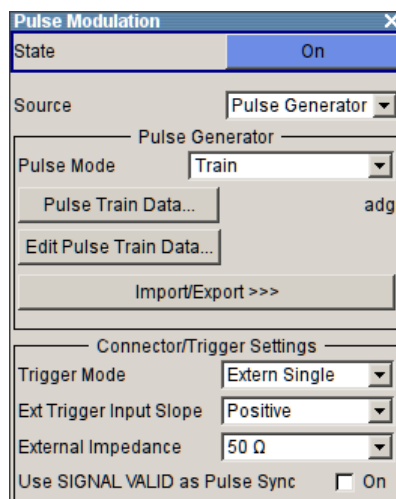

The instrument displays the parameters required for configuring pulse train data.

4. Select "Pulse Train Data... > New List / Select List or File Manager".
5. Navigate to the target directory and select an existing file, or create a new file by assigning the "File Name".
6. According to your selection, confirm with "Save" or "Select".

The R&S SMB automatically uses the new file for further editing. Pulse train data files have the fixed file extension *.pulstrn.

7. In the "Pulse Modulation" dialog, select "Edit Pulse Train Data... > Edit" to define the on and off time value pairs and the repetition factor for each value pair.
8. When completed, save the file.
9. Starting in the block diagram, perform the following steps to activate signal generation:
 - a) Select "Mod Gen > config... > Pulse Generator > Video/Sync Signal State > On".
 - b) Select "Modulation > config... > Pulse Modulation > State > On".
 - c) Activate RF signal generation in the "RF" block.

The R&S SMB generates an RF pulse sequence signal according to the values specified in the file.

Pulse Train Data – Pulse Generator

Opens the "File Select" dialog for selecting and creating a pulse train file, and provides access to the "File Manager".

Remote command:

[\[:SOURce<hw>\]:PULM:TRAI:n:CATalog?](#) on page 394

[\[:SOURce<hw>\]:PULM:TRAI:n:SElect](#) on page 398

[\[:SOURce<hw>\]:PULM:TRAI:n:DElete](#) on page 394

Edit Pulse Train Data – Pulse Generator

Opens the [Pulse Train Dialog](#).

Pulse Train Dialog

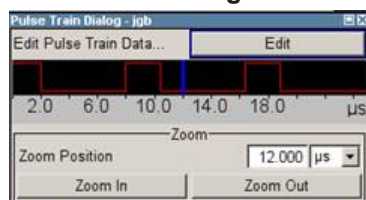

Displays the pulse sequence as defined in the file.

"Edit" Opens the pulse train dialog, see [Edit Pulse Train Data](#). The dialog graphically represents the pulse train signal and provides access to the data editor.

"Zoom Position" Sets the blue marker in the pulse train graph. The marker defines the center of any zoom in or zoom out action.

"Zoom In / Zoom Out" Enlarges the diagram by factor 2 per "Zoom In", or scales it down accordingly when you select "Zoom Out".

Edit Pulse Train Data

Opens an editor allowing you to enter the "On-Time / OFF-Time" value pairs in a table. In addition, you can assign a repetition rate to each pair. Based on these values, the instrument then generates the pulse train signal. You can enter any number of value pairs and save your list in a file. The file name is displayed in the header of the dialog.

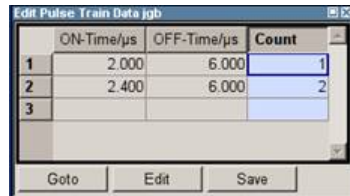

"ON-Time/µs" Determines the length of the respective pulse (signal is high).

Remote command:

[\[:SOURce<hw>\]:PULM:TRAI:n:ONTime](#) on page 396

"OFF-Time/µs" Determines the time length, the signal level of the pulse remains low.

Remote command:

[\[:SOURce<hw>\]:PULM:TRAI:n:OFFTime](#) on page 395

"Count" Sets the number of repetitions for each pulse ("ON-Time/µs"/"OFF-Time/µs" value pair).

Tip: If you set "Count = 0", the corresponding value pair is ignored in the pulse sequence. With this function you can skip value pairs individually, without deleting them from the table. This allows re-enabling a value pair by entering a number unequal to zero.

Remote command:

[\[:SOURce<hw>\]:PULM:TRAI:n:REPetition](#) on page 397

"Goto" Selects row for editing.

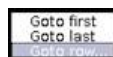

If Goto row is selected, a window opens for entering the requested row.



(it is not possible to change individual positions of the list)

"Edit" Opens a menu containing editing functions.



"Insert Row" Inserts a new row before the marked row.

"Insert Range" Inserts new rows before the marked row. The number of rows to be inserted can be defined in an entry window.

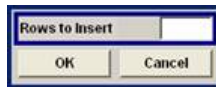

"Fill...." Opens a dialog for defining a set of list values to be automatically entered in the list. The start line and the number of rows to be filled are defined under "From" and "Range". The column to be filled is selected under "Select column to fill". Depending on the selection here, the default for start, end, and increment value are set. As the settings are interdependent, a change of one parameter may result in the automatic change of one or more of the other parameters. The filling of the column with the selected value settings is started with button "Fill".

"Delete Row" Deletes the marked row.

"Delete Range" Deletes the selected number of rows including the marked row. The number of rows to be inserted can be defined in an entry window.

"Save As" Opens the file dialog to save the list under a new name. Each list is saved to the CompactFlash™ card as a separate file with the file prefix *.pulstrn. The file name and the directory to which the file is saved are user-selectable.

"Save" The list is saved under its current name.

Import/Export - Pulse Train Mode

Expands the menu with the area for import and export of pulse train files.

Externally edited Excel tables with on/off time and repetition triplets can be imported as text files or CSV files and used for pulse train mode.

On the other hand, internally created pulse train lists can be exported as text files or CSV files.

Mode – Import/Export Pulse Train Files

Selects if pulse train lists should be imported or exported. The settings offered below depend on the selected mode.

Remote command:

[\[:SOURce<hw>\]:PULM:TRAI:n:DEXChange:MODE](#) on page 403

Extension – ASCII File Settings

Selects the file extension of the ASCII file to be imported or exported. Selection TXT (text file) or CSV (Excel file) is available.

Remote command:

[\[:SOURce<hw>\]:PULM:TRAI:n:DEXChange:AFILe:EXTension](#) on page 401

Decimal Point - ASCII File Settings

Selects the decimal separator used in the ASCII data between '.' (decimal point) and ',' (comma) with floating-point numerals.

Remote command:

`[:SOURce<hw>] :PULM:TRAI:n:DEXChange:AFILe:SEParator:DECimal`
on page 402

Column Separator- ASCII File Settings

Selects the separator between the frequency and level column of the ASCII table.

Remote command:

`[:SOURce<hw>] :PULM:TRAI:n:DEXChange:AFILe:SEParator:COLumn`
on page 402

Select ASCII Source / Destination - Import/Export Pulse Train Files

Opens the "File Manager" for selecting the ASCII file to be imported into a pulse train list (source) or the ASCII file the pulse train list is exported (destination) in.

Remote command:

`[:SOURce<hw>] :PULM:TRAI:n:DEXChange:AFILe:CATalog?` on page 400
`[:SOURce<hw>] :PULM:TRAI:n:DEXChange:AFILe:SELeCt` on page 401

Select Destination / Source - Import/Export Pulse Train Files

Opens the "File Manager" for selecting the pulse train list to be exported (source) into an ASCII file, or the destination for the ASCII file to be imported (destination) in.

Remote command:

`[:SOURce<hw>] :PULM:TRAI:n:DEXChange:SELeCt` on page 404

Import / Export - Import/Export Pulse Train Files

Starts the export or import of the selected file.

If import is selected, the ASCII file is imported as pulse train list.

If export is selected, the pulse train list is exported into the selected ASCII file.

Remote command:

`[:SOURce<hw>] :PULM:TRAI:n:DEXChange:EXECute` on page 403

6 Remote Control Basics

This chapter provides basic information on operating an instrument via remote control.

6.1 Remote Control Interfaces and Protocols

The instrument supports different interfaces for remote control. The following table gives an overview.

Table 6-1: Remote control interfaces and protocols

Interface	Protocols, VISA ^{*)} address string	Remarks
Local Area Network (LAN)	Protocols: <ul style="list-style-type: none"> HiSLIP High-Speed LAN Instrument Protocol (IVI-6.1) VISA^{*)} address string: TCPIP::host address:: hislip0[::INSTR] VXI-11 VISA^{*)} address string: TCPIP::host address[:: LAN device name][::INSTR] socket communication (Raw Ethernet, simple telnet) VISA^{*)} address string: TCPIP::host address[:: LAN device name]::<port>:: SOCKET 	A LAN connector is located on the front or rear panel of the instrument, or both. The interface is based on TCP/IP and supports various protocols. For a description of the protocols refer to: <ul style="list-style-type: none"> Chapter 6.1.3.1, "HiSLIP Protocol", on page 239 Chapter 6.1.3.2, "VXI-11 Protocol", on page 239 Chapter 6.1.3.3, "Socket Communication", on page 239
Serial Interface	VISA ^{*)} address string: ASRL[0-9][::INSTR]	For a description of the interface, refer to Chapter 6.1.5, "Serial Interface", on page 241.
GPIB (IEC/IEEE Bus Interface)	VISA ^{*)} address string: GPIB::primary address[::INSTR] (no secondary address)	Optional GPIB bus interfaces according to standard IEC 625.1/IEEE 488.1 are located on the rear panel of the instrument. For a description of the interface, refer to Chapter 6.1.6, "GPIB Interface (IEC/IEEE Bus Interface)", on page 241. Note: Within this interface description, the term GPIB is used as a synonym for the IEC/IEEE bus interface.

^{*)} VISA is a standardized software interface library providing input and output functions to communicate with instruments. A VISA installation on the controller is a prerequisite for remote control over LAN (when using VXI-11 or HiSLIP protocol), USB and serial interface. For remote control via socket communication VISA installation is optional. For more information, see Chapter 6.1.1, "VISA Libraries", on page 236.



Rohde & Schwarz provides the standardized I/O software library R&S VISA for communication via TCP/IP (LAN: HiSlip, VXI-11 and raw socket) or USB (USBTMC) interfaces.

R&S VISA is available for download at the Rohde & Schwarz website <http://www.rohde-schwarz.com/rsvisa>.

How to configure the remote control interfaces, see Chapter 6.2, "Starting a Remote Control Session", on page 244.

SCPI (Standard Commands for Programmable Instruments)

SCPI commands - messages - are used for remote control. Commands that are not taken from the SCPI standard follow the SCPI syntax rules. The instrument supports the SCPI version 1999. The SCPI standard is based on standard IEEE 488.2 and aims at the standardization of device-specific commands, error handling and the status registers. The tutorial "Automatic Measurement Control - A tutorial on SCPI and IEEE 488.2" from John M. Pieper (R&S order number 0002.3536.00) offers detailed information on concepts and definitions of SCPI.

Tables provide a fast overview of the bit assignment in the status registers. The tables are supplemented by a comprehensive description of the status registers.

6.1.1 VISA Libraries

VISA is a standardized software interface library providing input and output functions to communicate with instruments. Thus, you can configure the interface and must not adjust the application program to the used interface. The I/O channel (LAN or TCP/IP, USB, GPIB,...) is selected at initialization time with the channel-specific address string ("VISA resource string"), or by a defined VISA alias (short name). See also [Chapter 6.1, "Remote Control Interfaces and Protocols"](#), on page 235 for an overview.

Instrument access via VXI-11 or HiSLIP protocols is achieved from high level programming platforms using VISA as an intermediate abstraction layer. VISA encapsulates the low-level VXI or GPIB function calls and thus makes the transport interface transparent for the user.

A VISA installation is a prerequisite for remote control using the following interfaces:

- LAN Interface using [Chapter 6.1.3, "LAN Interface"](#), on page 237
- LAN interface using [Chapter 6.1.3.2, "VXI-11 Protocol"](#), on page 239
- [Chapter 6.1.4, "USB Interface"](#), on page 240
- [Chapter 6.1.6, "GPIB Interface \(IEC/IEEE Bus Interface\)"](#), on page 241
- [Chapter 6.1.5, "Serial Interface"](#), on page 241

Instrument access via the LAN socket protocol or GPIB connections can be operated both, with or without the VISA library.

See also [Chapter 6.1.3.3, "Socket Communication"](#), on page 239 and [Chapter 6.1.6, "GPIB Interface \(IEC/IEEE Bus Interface\)"](#), on page 241.

For more information about VISA, refer to the user documentation.

6.1.2 Messages

The messages transferred on the data lines are divided into the following categories:

- Interface messages
Interface messages are transmitted to the instrument on the data lines, with the attention line being active (LOW). They are used to communicate between the controller and the instrument. Interface messages can only be sent by instruments that have GPIB bus functionality. For details see the sections for the required interface.

- **Instrument messages**
Instrument messages are employed in the same way for all interfaces, if not indicated otherwise in the description. Structure and syntax of the instrument messages are described in [Chapter 6.3, "SCPI Command Structure"](#), on page 258. A detailed description of all messages available for the instrument is provided in the chapter "Remote Control Commands".
There are different types of instrument messages, depending on the direction they are sent:
 - Commands
 - Instrument responses

Commands

Commands (program messages) are messages the controller sends to the instrument. They operate the instrument functions and request information. The commands are subdivided according to two criteria:

- According to the effect they have on the instrument:
 - **Setting commands** cause instrument settings such as a reset of the instrument or setting the frequency.
 - **Queries** cause data to be provided for remote control, e.g. for identification of the instrument or polling a parameter value. Queries are formed by directly appending a question mark to the command header.
- According to their definition in standards:
 - **Common commands**: their function and syntax are precisely defined in standard IEEE 488.2. They are employed identically on all instruments (if implemented). They refer to functions such as management of the standardized status registers, reset and self-test.
 - **Instrument control commands** refer to functions depending on the features of the instrument such as frequency settings. Many of these commands have also been standardized by the SCPI committee. These commands are marked as "SCPI confirmed" in the command reference chapters. Commands without this SCPI label are device-specific; however, their syntax follows SCPI rules as permitted by the standard.

Instrument responses

Instrument responses (response messages and service requests) are messages the instrument sends to the controller after a query. They can contain measurement results, instrument settings and information on the instrument status.

6.1.3 LAN Interface

To be integrated in a LAN, the instrument is equipped with a LAN interface, consisting of a connector, a network interface card and protocols. For remote control via a network, the PC and the instrument must be connected via the LAN interface to a common network with TCP/IP network protocol. They are connected using a commercial RJ45 cable. The TCP/IP network protocol and the associated network services are

preconfigured on the instrument. Software for instrument control and (for specified protocols only) the VISA program library must be installed on the controller.

VISA library

Instrument access via VXI-11 or HiSLIP protocols is achieved from high level programming platforms using VISA as an intermediate abstraction layer. VISA encapsulates the low level VXI or GPIB function calls and thus makes the transport interface transparent for the user. See [Chapter 6.1.1, "VISA Libraries"](#), on page 236 for details.

IP address

Only the IP address or the computer name (LAN device name) is required to set up the connection. The IP address/computer name is part of the "visa resource string" used by the programs to identify and control the instrument.

Forms of the VISA resource string:

- `TCPIP::host address[::LAN device name][::INSTR]`
- `TCPIP::host address::port::SOCKET`

Where:

- `TCPIP` designates the network protocol used
- `host address` is the IP address or host name of the device
- `LAN device name` defines the protocol and the instance number of a subinstrument:
 - `inst0` selects the VXI-11 protocol (optional, default)
 - `hislip0` selects the newer HiSLIP protocol
- `INSTR` indicates the instrument resource class (optional)
- `port` determines the used port number
- `SOCKET` indicates the raw network socket resource class

Example:

- Instrument has the IP address `192.1.2.3`; the valid resource string using VXI-11 protocol is:
`TCPIP::192.1.2.3::INSTR`
- The DNS host name is `RSSM1`; the valid resource string is:
`TCPIP::RSSM1::hislip0` (HiSLIP)
`TCPIP::RSSM1::INSTR` (VXI-11)
- A raw socket connection can be established using:
`TCPIP::192.1.2.3::5025::SOCKET`



Identifying instruments in a network

If several instruments are connected to the network, each instrument has its own IP address and associated resource string. The controller identifies these instruments by the resource string.

6.1.3.1 HiSLIP Protocol

The HiSLIP (**H**igh **S**peed **L**AN **I**nstrument **P**rotocol) is the successor protocol for VXI-11 for TCP-based instruments specified by the IVI foundation. The protocol uses two TCP sockets for a single connection - one for fast data transfer, the other for non-sequential control commands (e.g. `Device Clear` or `SRQ`).

HiSLIP has the following characteristics:

- High performance as with raw socket network connections
- Compatible IEEE 488.2 support for Message Exchange Protocol, Device Clear, Serial Poll, Remote/Local, Trigger, and Service Request
- Uses a single IANA registered port (4880), which simplifies the configuration of firewalls
- Supports simultaneous access of multiple users by providing versatile locking mechanisms
- Usable for IPv6 or IPv4 networks



Using VXI-11, each operation is blocked until a VXI-11 device handshake returns. However, using HiSLIP, data is sent to the device using the "fire and forget" method with immediate return. Thus, a successful return of a VISA operation such as `viWrite()` does not guarantee that the instrument has finished or started the requested command, but is delivered to the TCP/IP buffers.

For more information see also the application note: [1MA208: Fast Remote Instrument Control with HiSLIP](#).

6.1.3.2 VXI-11 Protocol

The VXI-11 standard is based on the ONC RPC (Open Network Computing Remote Procedure Call) protocol which in turn relies on TCP/IP as the network/transport layer. The TCP/IP network protocol and the associated network services are preconfigured. TCP/IP ensures connection-oriented communication, where the order of the exchanged messages is adhered to and interrupted links are identified. With this protocol, messages cannot be lost.

6.1.3.3 Socket Communication

An alternative way for remote control of the software is to establish a simple network communication using sockets. The socket communication, also referred to as "Raw Ethernet communication", does not necessarily require a VISA installation on the remote controller side. It is available by default on all operating systems.

The simplest way to establish socket communication is to use the built-in telnet program. The telnet program is part of every operating system and supports a communication with the software on a command-by-command basis. For more convenience and to enable automation by means of programs, user-defined sockets can be programmed.

Socket connections are established on a specially defined port. The socket address is a combination of the IP address or the host name of the instrument and the number of the port configured for remote-control. All R&S SMB use port number 5025 for this purpose. The port is configured for communication on a command-to-command basis and for remote control from a program.

6.1.3.4 LAN Interface Messages

In the LAN connection, the interface messages are called low-level control messages. These messages can be used to emulate interface messages of the GPIB bus.

Command	Long term	Effect on the instrument
&ABO	Abort	Aborts processing of the commands just received.
&DCL	Device Clear	Aborts processing of the commands just received and sets the command processing software to a defined initial state. Does not change the instrument setting.
>L	Go to Local	Transition to the "local" state (manual control). (The instrument automatically returns to remote state when a remote command is sent UNLESS &NREN was sent before.)
>R	Go to Remote	Enables automatic transition from local state to remote state by a subsequent remote command (after &NREN was sent).
&GET	Group Execute Trigger	Triggers a previously active instrument function (e.g. a sweep). The effect of the command is the same as with that of a pulse at the external trigger signal input.
&LLO	Local Lockout	Disables transition from remote control to manual control by means of the front panel keys.
&NREN	Not Remote Enable	Disables automatic transition from local state to remote state by a subsequent remote command. (To re-activate automatic transition use >R.)
&POL	Serial Poll	Starts a serial poll.

6.1.4 USB Interface

For remote control via the USB connection, the PC and the instrument must be connected via the USB type B interface. A USB connection requires the VISA library to be installed. VISA detects and configures the R&S instrument automatically when the USB connection is established. You do not have to enter an address string or install a separate driver.

USB address

The used USB address string is:

```
USB::::<product ID>::::INSTR]
```

Where:

- <vendor ID> is the vendor ID for Rohde&Schwarz
- <product ID> is the product ID for the R&S instrument
- <serial number> is the individual serial number on the rear of the instrument

Example:

```
USB::0x0AAD::0x0054::100001::INSTR
```

0x0AAD is the vendor ID for Rohde&Schwarz

0x0054 is the product ID for the R&S SMB

100001 is the serial number of the particular instrument

6.1.5 Serial Interface

Remote control via the serial interface is possible either via RS232 interface or via a Bluetooth connection. The controller/Bluetooth device and the instrument must be connected via an external USB/serial-adapter (see recommended extras, data sheet) and a serial crossover (null modem) cable. A USB connection requires the VISA library to be installed on the controller. VISA detects and configures the R&S SMB automatically when the USB connection is established.

Serial address

The used serial address string is:

```
ASRL[0-9] [ : : INSTR ]
```

Where `ASRL[0-9]` determines the number of the COM port on the controller side, that has to be used for the serial connection.

Access via a bluetooth device requires the entry of the bluetooth pin in addition (see [Chapter 5.2.3.18, "Security"](#), on page 114).

To enable an error-free and correct data transmission, the parameters of the generator and the controller must have the same setting. The serial interface is preset for a baud rate 115200, no parity and one stop bit. The parameters can be manually changed in "Remote Channel Settings" dialog (see [Chapter 5.2.3.14, "Remote Channel Settings"](#), on page 108).

6.1.6 GPIB Interface (IEC/IEEE Bus Interface)

To be able to control the instrument via the GPIB bus, the instrument and the controller must be linked by a GPIB bus cable. A GPIB bus card, the card drivers and the program libraries for the programming language used must be provided in the controller. The controller must address the instrument with the GPIB bus address (see [Chapter 6.1.6.2, "GPIB Instrument Address"](#), on page 243).

Characteristics

The GPIB interface is described by the following characteristics:

- Up to 15 instruments can be connected

- The total cable length is restricted to a maximum of 15 m; the cable length between two instruments should not exceed 2m.
- A wired "OR"-connection is used if several instruments are connected in parallel, since the slowest instrument determines the speed.



Any connected IEC bus cable must be terminated by an instrument or controller.

6.1.6.1 GPIB Interface Messages

Interface messages are transmitted to the instrument on the data lines, with the attention line (ATN) being active (LOW). They are used for communication between the controller and the instrument and can only be sent by a computer which has the function of a GPIB bus controller. GPIB interface messages can be further subdivided into:

- **Universal commands:** act on all instruments connected to the GPIB bus without previous addressing
- **Addressed commands:** only act on instruments previously addressed as listeners

Universal Commands

Universal commands are encoded in the range 10 through 1F hex. They affect all instruments connected to the bus and do not require addressing.

Command	Effect on the instrument
DCL (Device Clear)	Aborts the processing of the commands just received and sets the command processing software to a defined initial state. Does not change the instrument settings.
IFC (Interface Clear *)	Resets the interfaces to the default setting.
LLO (Local Lockout)	The LOC/IEC ADDR key is disabled.
SPE (Serial Poll Enable)	Ready for serial poll.
SPD (Serial Poll Disable)	End of serial poll.
PPU (Parallel Poll Unconfigure)	End of the parallel-poll state.
*) IFC is not a real universal command, it is sent via a separate line; however, it also affects all instruments connected to the bus and does not require addressing	

Addressed Commands

Addressed commands are encoded in the range 00 through 0F hex. They only affect instruments addressed as listeners.

Command	Effect on the instrument
GET (Group Execute Trigger)	Triggers a previously active instrument function (e.g. a sweep). The effect of the command is the same as with that of a pulse at the external trigger signal input.
GTL (Go to Local)	Transition to the "local" state (manual control).
GTR (Go to Remote)	Transition to the "remote" state (remote control).
PPC (Parallel Poll Configure)	Configures the instrument for parallel poll.
SDC (Selected Device Clear)	Aborts the processing of the commands just received and sets the command processing software to a defined initial state. Does not change the instrument setting.

6.1.6.2 GPIB Instrument Address

In order to operate the instrument via remote control, it must be addressed using the GPIB address. The remote control address is factory preset, but it can be changed if it does not fit in the network environment. For remote control, addresses 0 through 30 are allowed. The GPIB address is maintained after a reset of the instrument settings.

Changing the GPIB address of the instrument

The GPIB address can be changed manually or using a remote control command.

1. Manually: press the SETUP key.
2. Select "Remote > GPIB".

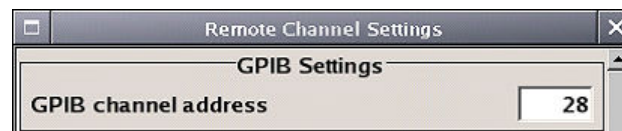

3. Enter the GPIB address.
4. Remotely: use the remote control command:
`SYST:COMM:GPIB:ADDR 18`

6.1.7 LXI Browser Interface

LAN extension for instrumentation (LXI) is an instrumentation platform for measuring instruments and test systems that is based on standard Ethernet technology, see also [Chapter 2.8, "LXI Configuration"](#), on page 45.

The LXI browser interface allows easy configuration of the LAN and remote control of the R&S SMB without additional installation requirements. The instrument's LXI browser interface works correctly with all W3C compliant browsers.

The LAN settings are configured using the LXI Browser Interface of the R&S SMB described in [Chapter 2.8.2, "LAN Configuration"](#), on page 47. The LXI status settings in the R&S SMB are described in [Chapter 5.2.3.16, "LXI Status"](#), on page 112.

6.2 Starting a Remote Control Session

The instrument and the controller have to be connected with the suitable cable and switched on.

A remote control program must open a connection to the instrument (using VISA functionality), before it can send commands to and receive device responses from the instrument.



Instrument Address

In order to operate the instrument via remote control it must be addressed using the defined interface address. See [Chapter 6.1.3, "LAN Interface"](#), on page 237, [Chapter 6.1.4, "USB Interface"](#), on page 240, [Chapter 6.1.5, "Serial Interface"](#), on page 241, [Chapter 6.1.6, "GPIB Interface \(IEC/IEEE Bus Interface\)"](#), on page 241 or [Chapter 6.1.7, "LXI Browser Interface"](#), on page 243 for details.

The VISA resource strings are indicated in the "Setup > Remote Channel Settings" menu.



Securing the display

To prevent unauthorized personnel from reading the display, you can disable the frequency and level display explicitly. This is useful when you remotely control the instrument from a different location.

For information on how to disable the frequency and level display, refer to ["Annotation Frequency"](#) on page 118 and ["Annotation Amplitude"](#) on page 118.

Refer to [Chapter 6.2.3, "Examples"](#), on page 245 for practical examples on setting up a remote control link and starting of a remote control session.

6.2.1 Switching to Remote Control

After switching on, the instrument is usually in the local state and can be operated via the front panel controls (for instruments equipped with a display), a mouse and an external keyboard.

Starting remote control

1. Send a command from a controller to the instrument.

The instrument changes to remote state as soon as it receives the command from the controller.

Note: If you have sent `&NREN` before, the automatic transition from local state to manual control by a subsequent remote command is disabled (use `>R` to enable it again).

In remote state, operation via the front panel or via mouse and keyboard is disabled. The status line indicates the "REMOTE" state.

The instrument remains in the remote state until it is reset to the local state, see [Chapter 6.2.2, "Returning to Manual Operation"](#), on page 245).

Tip: Switching from manual operation to remote control and vice versa does not affect the other instrument settings.

2. Although operation via front panel, mouse and keyboard is disabled, the dialog boxes can still be opened, for example to verify settings. The buttons and setting fields are grayed out and cannot be activated.
Additionally, you can disable the access to the dialogs with the command `SYST:KLOC ON` to protect the instrument against unauthorized readings.
3. To prevent unintentional return to manual operation, disable the LOCAL key of the instrument with the `&LLO` command (see [Chapter 6.1.3.4, "LAN Interface Messages"](#), on page 240).
The instrument switches to "REM-LLO" state.
The automatic transition from local state to remote state by a subsequent remote command, and the command `*GTL` are disabled.
To return to manual mode is only possible via remote control.
4. Unlock the LOCAL key with `>R`.

6.2.2 Returning to Manual Operation



Before returning to manual control, command processing must be completed. Otherwise, the instrument switches back to remote control immediately.

To return to manual operation, perform one of the following:

- Press the LOCAL key on the front panel.
- Select "Setup > Remote Control Channels > Local".
- While using the socket communication, terminate the remote control session.
- Send the interface command `>L` via the remote control interface.



Use the `>R` to enable the LOCAL key if it is locked.

6.2.3 Examples

This sections provides examples for setting up the remote control connection, and starting a remote control session.

This section assumes basic knowledge of programming and operation of the controller. A description of the interface commands can be obtained from the corresponding manuals.

6.2.3.1 Remote Control over GPIB

The program example in this section is written in VISUAL BASIC. A condition for programming in VISUAL BASIC is that the modules NIGLOBAL (`Niglobal.bas`) and VBIB32 (`Vbib_32.bas`) are added to the projects.



Drivers for instrument, e.g. IVI-COM and LabVIEW drivers, are available in the download area of the product website (http://www.rohde-schwarz.com/en/products/test_and_measurement/product_categories/signal_generation/).

Starting a remote control session over GPIB

As a prerequisite, the GPIB address of the instrument, which is factory-set to 28, must not have been changed.

1. Connect instrument and controller using GPIB cable and switch them on.
2. Execute following commands on the controller:

a) Open port to the instrument

```
CALL IBFIND("DEV1", generator%)
```

b) Inform controller about instrument address

```
CALL IBPAD(generator%, 28)
```

c) Reset instrument

```
CALL IBWRT(generator%, "*RST;*CLS")
```

d) Set instrument to new address

```
CALL IBWRT(generator%, "SYST:COMM:GPIB:ADDR 18")
```

e) Inform controller about new address

```
CALL IBPAD(generator%, 18)
```

The GPIB address of the instrument is changed.

3. To return to manual operation sent `CALL IBLOC (generator%)` or press the LOCAL key at the front panel.

6.2.3.2 Remote Control over LAN using VXI-11 Protocol

In this example, the I/O software library R&S VISA from Rohde & Schwarz is used to set up a LAN remote control link and remotely control the R&S SMB. R&S VISA is running on a controller PC with Windows operating system. When the connection is set up you can send commands to the instrument, and receive the responses.

The remote control connection requires a VISA installation but no additional hardware on the controller PC. The LAN I/O channel is selected at initialization time using the VISA resource string (also referred to as "address string"). A VISA alias (short name) is used to replace the complete resource string. The host address is either the R&S SMB's hostname or IP address. See also [Chapter 6.1.3, "LAN Interface"](#), on page 237.



In this example, it is assumed that:

- A LAN remote control link between the controller and the R&S SMB is already set up.
- The R&S VISA program is installed on the remote PC, see "<http://www.rohde-schwarz.com/rsvisa> > RS VISA Release Notes".

Configuring the controller

To remote control the R&S SMB, we use the R&S VISA Tester application.



The instrument is preconfigured for networks using DHCP (dynamic host configuration protocol). If this configuration is used, enter the computer name in the position of the IP address.

To enable the external controller to communicate with the R&S SMB via TCP/IP protocol, set up a remote control link as follows:

1. Make sure that the controller and the instrument are connected in the network (network cable) and switched on.
2. On the controller, start "R&S VISA > Tester 32bit" or "R&S VISA > Tester 64bit", respectively.

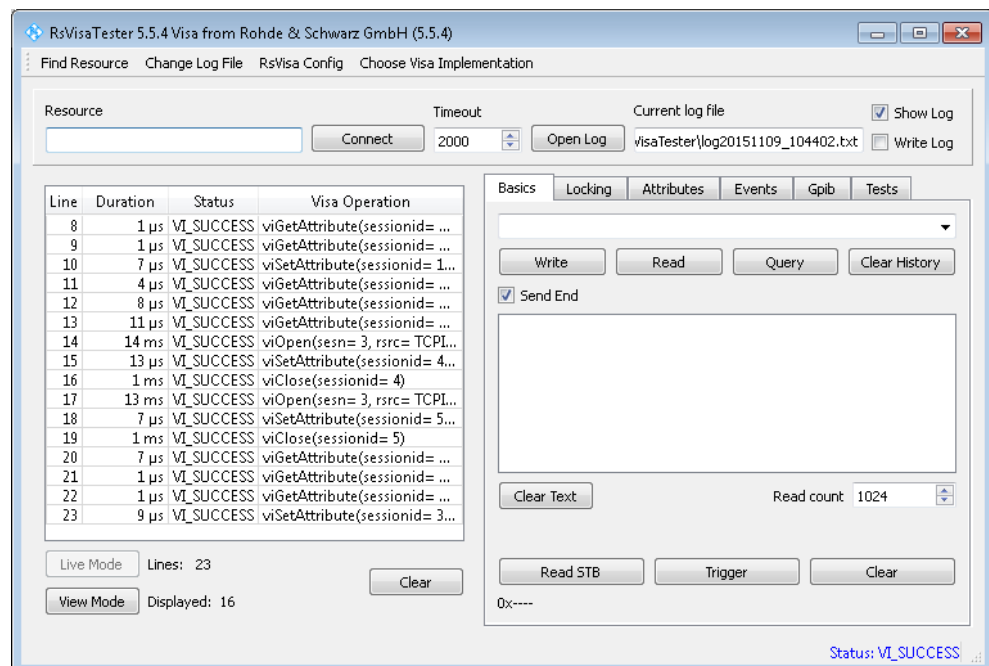

3. In the menu bar, select "Choose VISA Implementation > Rohde & Schwarz Visa".



4. Select "Rohde & Schwarz Visa" and confirm with "OK".
5. In the menu bar, select "Find Resource" to search for the instrument in the LAN.

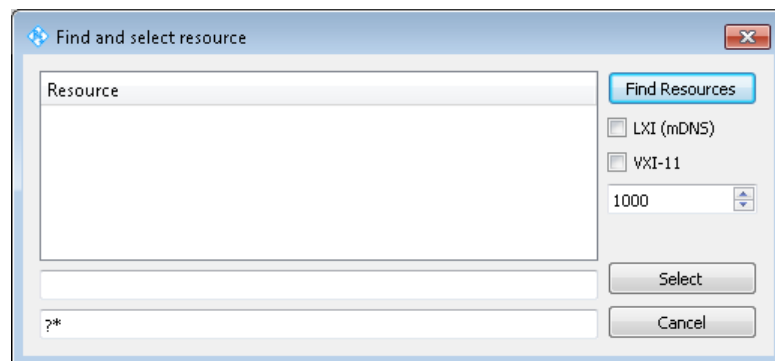

6. Select "VXI-11" and "Find Resources".

R&S VISA scans the network for connected instruments and lists all detected instruments in the "Resource" list.

Note: The search may take some time, particularly in large networks.

7. Select the required instrument and confirm with "Select".

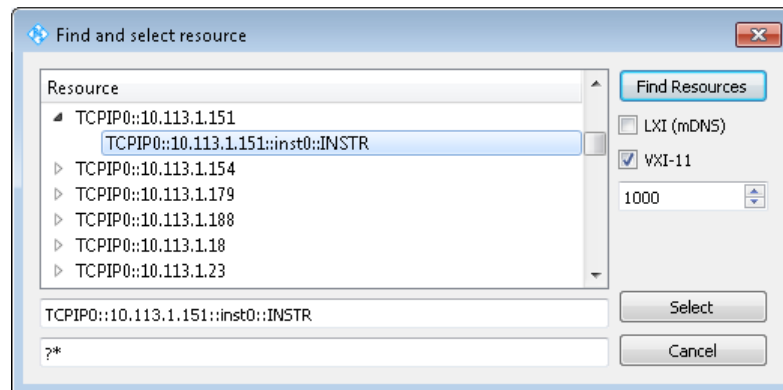

The "Find and select resource" dialog closes and R&S VISA indicates the instrument's IP address in the "Resource" field of the main application window.

8. As an alternative to the IP address, you can assign an alias name to the R&S SMB:

- a) In the menu bar, select "RsVisaConfig".

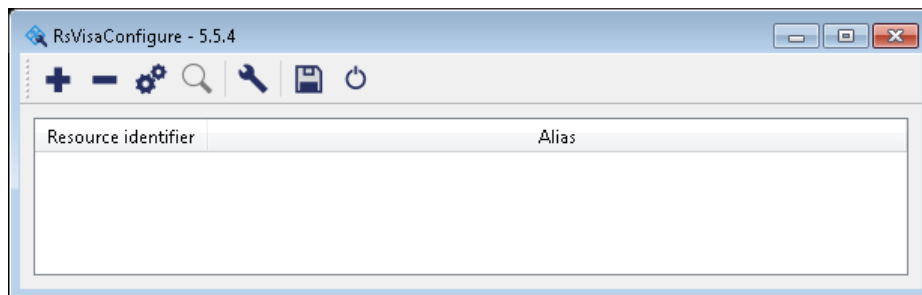

- b) In the toolbar, select "+" to access the "VISA Resource String Composer".
 c) Fill in the "Alias" name, the "VISA Resource String" and the "Device IP Address or host name" as shown in the figure, and confirm with "OK".

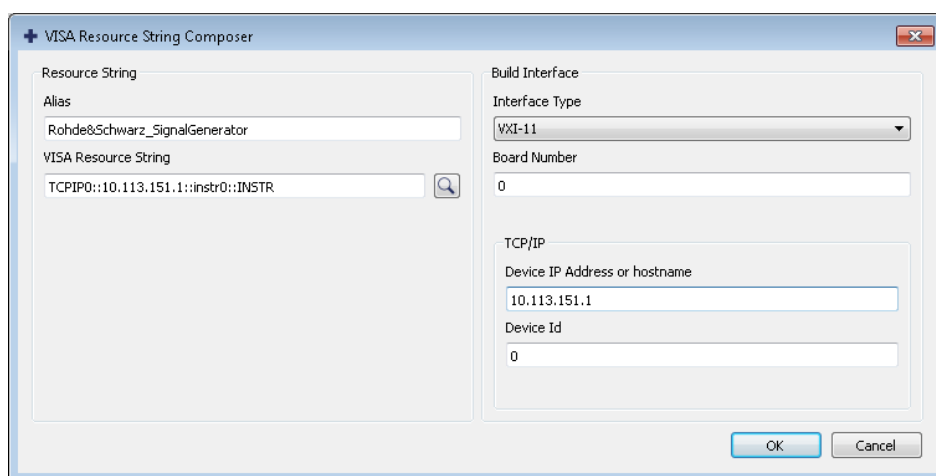

The "Alias" name is assigned to the instrument.



- d) Close the dialog.
 The R&S SMB is now registered in the program and can be addressed via the resource string or alias name.
9. In the main window, select "Connect".
 R&S VISA establishes the connection to the R&S SMB.
 Now you can send settings to configure the instrument and receive its responses.

Note: If the connection cannot be set up, R&S VISA displays an error in the log view. For information on how to proceed when network failures occur, see [Chapter 9.5, "Resolving Network Connection Failures"](#), on page 487.

For further information on the functions to read and write to an open session, as well as the utility applications the software provides, see the R&S VISA User Manual.

Starting a remote control over LAN (using VXI-11)

To set the instrument to remote control, you can use the addressed command `>R`, or send any command from the controller.

1. Start the R&S VISA Tester and establish the connection to the R&S SMB, see ["Configuring the controller"](#) on page 247.
2. In the R&S VISA "Basics" tab, enter a SCPI command, e.g. `"*IDN?"` and confirm with "Query".

The instrument is switched to remote control when it receives a command from the controller.

3. Select "Read" to obtain the instrument response.

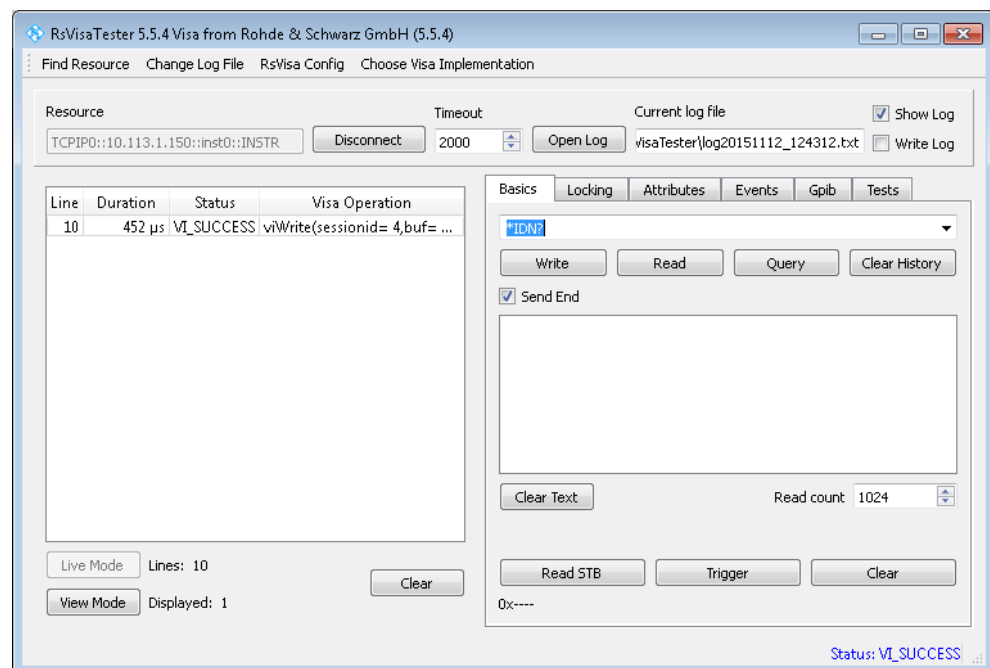

Tip: If the "Show Log" checkbox is checked R&S VISA displays each VISA function call in the log-view on the left. If you check the "Write Log" checkbox the log-view entry is written to the log file as well. You can operate the log-view in two modes: the "Live Mode" shows only the most recent messages whereas the "View Mode" allows you to scroll the history.

4. To set, e.g. the frequency, enter `SOUR1:FREQ 4 GHz` and select "Write". To check the performed setting, `SOUR1:FREQ?` and select "Read".

The instrument response is 4000000000, i.e. the frequency is returned in Hz.

While remote control is active, the "Remote" icon in the status bar indicates that the instrument is in remote control mode. The operation via the front panel or via mouse and keyboard are locked, allowing a remote control program to be performed without interruption.

On the display, keys and entry fields are grayed out and cannot be activated or modified, but you can still open dialogs, for example to verify settings.

5. To disable the access to the dialogs, use the command `SYST:KLOC ON`.
6. To prevent unintentional return to manual operation, use the command `&LLO`. See also [Chapter 6.1.3.4, "LAN Interface Messages"](#), on page 240.

The instrument switches to "Remote LLO" state. The LOCAL key is disabled.

7. To enable the LOCAL key, use the command `>R`.
8. To return to manual operation, see [Chapter 6.2.2, "Returning to Manual Operation"](#), on page 245.

Tip: Switching from manual operation to remote control and vice versa does not affect the other instrument settings.

6.2.3.3 Remote Control over LAN using Socket Communication

This chapter provides an example on how to establish a remote control connection over telnet protocol and a simple sockets-based program example that can be further developed.

Setting up a Telnet Connection

To control the software, only a telnet program is required. The telnet program is part of every operating system.

1. To establish a Telnet connection with the R&S SMB, start the telnet program.
2. Enter the access string to connect to the instrument and confirm with ENTER. The access string is composed of the open command short form) and the socket address. The socket address is a combination of the IP address or the host name of the R&S SMB and the number of the port configured for remote-control via telnet. The R&S SMB uses the port number 5025 for remote connection via Telnet. Example: `o 10.113.1.150 5025`

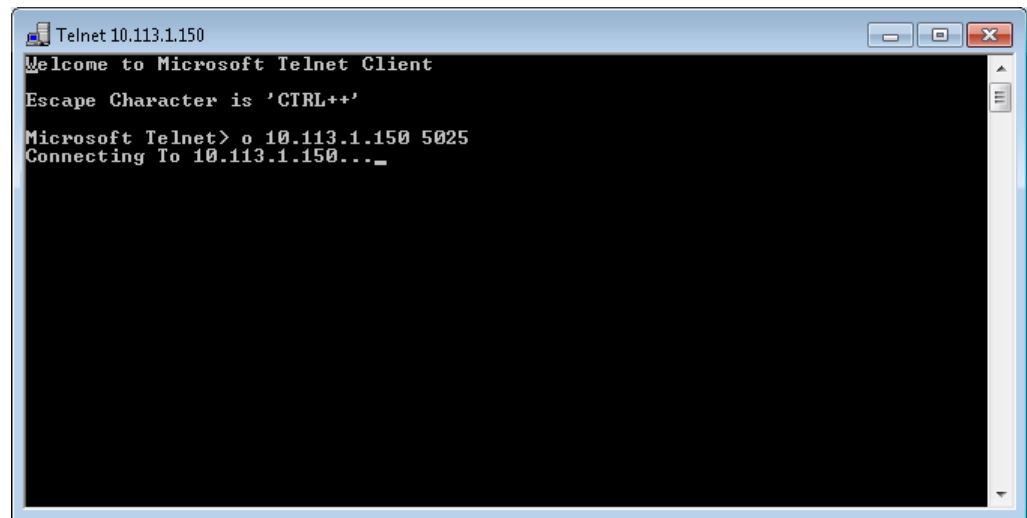

```
Telnet 10.113.1.150
Welcome to Microsoft Telnet Client
Escape Character is 'CTRL++'
Microsoft Telnet> o 10.113.1.150 5025
Connecting To 10.113.1.150..._
```

The connection to the instrument is set up and you can send remote-control commands.

3. Even if the cursor is not visible on the screen, enter blind a remote-control command and confirm with "Enter".

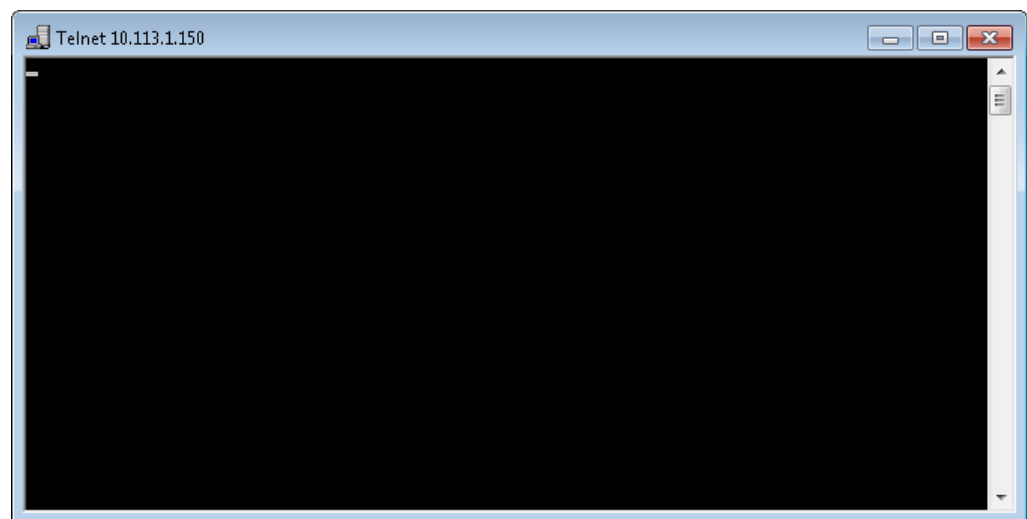

```
Telnet 10.113.1.150
_
```

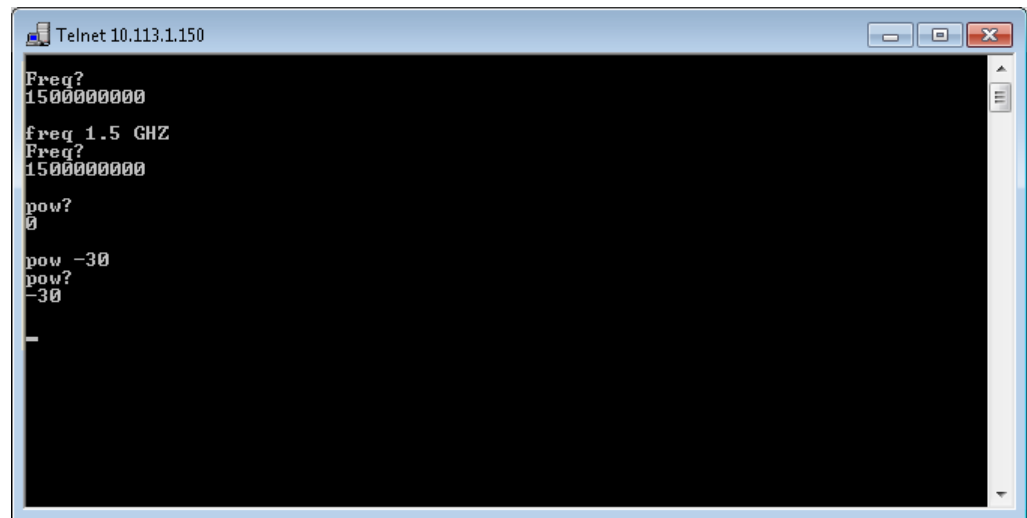

```

Telnet 10.113.1.150
Freq?
1500000000
freq 1.5 GHZ
Freq?
1500000000
pow?
0
pow -30
pow?
-30
-

```

After the first remote-control command has been sent, the instrument is in the "REMOTE" state, i.e. instrument control from the front panel or via mouse and keyboard is disabled and "REMOTE" is displayed in the status line.

Telnet program examples

The following program example shows a simple TcpClient class that is intended to explain on how to get started with programming of sockets.

The example sets up a socket communication to R&S SMB and opens a simple user interface, very similar to the telnet, which allows input of commands. To enable real automation, further development of the program is required.

TcpClient.h

```

#include <string>
//defines structs for socket handling
#include <netinet/in.h>
using namespace std;
typedef struct sockaddr_in SockAddrStruct;
typedef struct hostent      HostInfoStruct;
class TcpClient
{
public:
    TcpClient();
    ~TcpClient();
    void connectToServer( string &hostname, int port );
    void disconnect( );
    void transmit( string &txString );
    void receive( string &rxString );
    string getCurrentHostName( ) const;
    int    getCurrentPort( ) const;
private:
    string      currentHostName;
    int        currentPort;

```

```

        int                currentSocketDescr;
        SockAddrStruct     serverAddress;
        HostInfoStruct *   currentHostInfo;
        bool               clientIsConnected;
        int                receiveBufferSize;
};

```

TcpClient.cpp

```

#include <string>
//defines structs for socket handling
#include <netinet/in.h>
using namespace std;
typedef struct sockaddr_in SockAddrStruct;
typedef struct hostent     HostInfoStruct;
class TcpClient
{
public:
    TcpClient();
    ~TcpClient();
    void connectToServer( string &hostname, int port );
    void disconnect( );
    void transmit( string &txString );
    void receive( string &rxString );
    string getCurrentHostName( ) const;
    int    getCurrentPort( ) const;
private:
    string          currentHostName;
    int             currentPort;
    int             currentSocketDescr;
    SockAddrStruct serverAddress;
    HostInfoStruct * currentHostInfo;
    bool           clientIsConnected;
    int            receiveBufferSize;
};

#include <netdb.h>
#include <netinet/in.h>
#include <unistd.h>
#include "TcpClient.h"
TcpClient::TcpClient()
: currentHostName( "" )
, currentPort( 0 )
, currentSocketDescr( 0 )
, serverAddress ( )
, currentHostInfo( NULL )
, clientIsConnected( false )
, receiveBufferSize( 1024 )
{
}

```

```
TcpClient::~TcpClient()
{
    currentHostInfo = NULL;
}

void TcpClient::connectToServer( string &hostname, int port )
{
    currentHostInfo = gethostbyname( hostname.c_str( ) );
    if( currentHostInfo == NULL )
    {
        currentHostName = "";
        currentPort = 0;
        currentHostInfo = NULL;
        clientIsConnected = false;
        printf("error connecting host\n" );
    }
    currentHostName = hostname;
    currentPort = port;
    currentSocketDescr = socket(AF_INET, SOCK_STREAM, 0);
    if( currentSocketDescr == 0 )
    {
        currentHostName = "";
        currentPort = 0;
        currentHostInfo = NULL;
        clientIsConnected = false;
        printf("can't create socket\n" );
    }
    serverAddress.sin_family = currentHostInfo->h_addrtype;
    serverAddress.sin_port = htons( currentPort );
    memcpy( (char *) &serverAddress.sin_addr.s_addr,
        currentHostInfo->h_addr_list[0], currentHostInfo->h_length );
    if( connect( currentSocketDescr, ( struct sockaddr *) &serverAddress,
        sizeof( serverAddress ) ) < 0 )
    {
        throw string("can't connect server\n" );
    }
    clientIsConnected = true;
}

void TcpClient::disconnect( )
{
    if( clientIsConnected )
    {
        close( currentSocketDescr );
    }
    currentSocketDescr = 0;
    currentHostName = "";
    currentPort = 0;
    currentHostInfo = NULL;
    clientIsConnected = false;
}
```

```

void TcpClient::transmit( string &txString )
{
    if( !clientIsConnected )
    {
        throw string("connection must be established before any data can be sent\n");
    }
    char * transmitBuffer = new char[txString.length() +1];
    memcpy( transmitBuffer, txString.c_str(), txString.length() );
    transmitBuffer[txString.length()] = '\n'; //newline is needed!
    if( send( currentSocketDescr, transmitBuffer, txString.length() + 1, 0 ) < 0 )
    {
        throw string("can't transmit data\n");
    }
    delete [] transmitBuffer;
}

void TcpClient::receive( string &rxString )
{
    if( !clientIsConnected )
    {
        throw string("connection must be established before any data can be received\n");
    }
    char * receiveBuffer = new char[receiveBufferSize];
    memset( receiveBuffer, 0, receiveBufferSize );
    bool receiving = true;
    while( receiving )
    {
        int receivedByteCount = recv( currentSocketDescr,
            receiveBuffer, receiveBufferSize, 0 );
        if( receivedByteCount < 0 )
        {
            throw string("error while receiving data\n");
        }
        rxString += string( receiveBuffer );
        receiving = ( receivedByteCount == receiveBufferSize );
    }
    delete [] receiveBuffer;
}

string TcpClient::getCurrentHostName( ) const
{
    return currentHostName;
}

int TcpClient::getCurrentPort( ) const
{
    return currentPort;
}

```

TelnetClient.cpp

```

#include <iostream>
#include "TcpClient.h"

```

```
void printUsage()
{
    cout<<"usage: EthernetRawCommand <server-ip> [scpi-command]"<<endl;
}
int main( int argc, char *argv[] )
{
    int errorCode          = 0; //no error
    bool useSingleCommand = false;
    string singleCommand  = "";
    string hostname       = "";
    int    port           = 5025;
    string input          = "";
    TcpClient client;
    switch( argc )
    {
        case 3:
            useSingleCommand = true;
            singleCommand    = argv[2];
        case 2:
            hostname         = argv[1];
            break;
        default:
            printUsage();
            return(-1);
    }
    try
    {
        client.connectToServer( hostname, port );
        bool terminate = false;
        while( !terminate )
        {
            char buffer[1024];
            if( useSingleCommand )
            {
                input = singleCommand; //send string
            }
            else
            {
                cin.getline( buffer, 1024 );
                input = buffer;
                if( input == "end" )
                {
                    terminate = true;
                }
            }
        }
        if( !terminate)
        {
            client.transmit( input ); //send string
            int qPos = input.find( "?", 0 );
            //receive string only when needed
        }
    }
}
```



```

        if( qPos > 0 )
        {
            string rcStr = "";
            client.receive( rcStr );
            cout << rcStr << endl;
        }
    }
    if( useSingleCommand )
    {
        terminate = true;
    }
}
} catch( const string errorString )
{
    cout<<errorString<<endl;
}
client.disconnect( );
return errorCode;
}

```

6.3 SCPI Command Structure

SCPI commands consist of a so-called header and, in most cases, one or more parameters. The header and the parameters are separated by a "white space" (ASCII code 0 to 9, 11 to 32 decimal, e.g. blank). The headers may consist of several mnemonics (keywords). Queries are formed by appending a question mark directly to the header.

The commands can be either device-specific or device-independent (common commands). Common and device-specific commands differ in their syntax.

6.3.1 Syntax for Common Commands

Common (=device-independent) commands consist of a header preceded by an asterisk (*) and possibly one or more parameters.

Examples:

*RST	RESET	Resets the instrument.
*ESE	EVENT STATUS ENABLE	Sets the bits of the event status enable registers.
*ESR?	EVENT STATUS QUERY	Queries the contents of the event status register.
*IDN?	IDENTIFICATION QUERY	Queries the instrument identification string.

6.3.2 Syntax for Device-Specific Commands



Not all commands used in the following examples are necessarily implemented in the instrument.

For demonstration purposes only, assume the existence of the following commands for this section:

- DISPLAY[:WINDow<1...4>]:MAXimize <Boolean>
- FORMat:READings:DATA <type>[,<length>]
- HCOpy:DEvice:COLor <Boolean>
- HCOpy:DEvice:CMAP:COLor:RGB <red>,<green>,<blue>
- HCOpy[:IMMediate]
- HCOpy:ITEM:ALL
- HCOpy:ITEM:LABel <string>
- HCOpy:PAGE:DIMensions:QUADrant [<N>]
- HCOpy:PAGE:ORientation LANDscape | PORTrait
- HCOpy:PAGE:SCALE <numeric value>
- MMEMory:COpy <file_source>,<file_destination>
- SENSE:BANDwidth|BWIDth[:RESolution] <numeric_value>
- SENSE:FREQuency:STOP <numeric value>
- SENSE:LIST:FREQuency <numeric_value>{,<numeric_value>}

Long and short form

The mnemonics feature a long form and a short form. The short form is marked by upper case letters, the long form corresponds to the complete word. Either the short form or the long form can be entered; other abbreviations are not permitted.

Example:

HCOpy:DEvice:COLor ON is equivalent to HCOP:DEV:COL ON.



Case-insensitivity

Upper case and lower case notation only serves to distinguish the two forms in the manual, the instrument itself is case-insensitive.

Numeric suffixes

If a command can be applied to multiple instances of an object, e.g. specific channels or sources, the required instances can be specified by a suffix added to the command. Numeric suffixes are indicated by angular brackets (<1...4>, <n>, <i>) and are replaced by a single value in the command. Entries without a suffix are interpreted as having the suffix 1.

Example:

Definition: `HCOPY:PAGE:DIMensions:QUADrant [<N>]`

Command: `HCOP:PAGE:DIM:QUAD2`

This command refers to the quadrant 2.

**Different numbering in remote control**

For remote control, the suffix may differ from the number of the corresponding selection used in manual operation. SCPI prescribes that suffix counting starts with 1. Suffix 1 is the default state and used when no specific suffix is specified.

Some standards define a fixed numbering, starting with 0. If the numbering differs in manual operation and remote control, it is indicated for the corresponding command.

Optional mnemonics

Some command systems permit certain mnemonics to be inserted into the header or omitted. These mnemonics are marked by square brackets in the description. The instrument must recognize the long command to comply with the SCPI standard. Some commands are considerably shortened by these optional mnemonics.

Example:

Definition: `HCOPY[:IMMEDIATE]`

Command: `HCOP:IMM` is equivalent to `HCOP`

**Optional mnemonics with numeric suffixes**

Do not omit an optional mnemonic if it includes a numeric suffix that is relevant for the effect of the command.

Example:

Definition: `DISPlay[:WINDow<1...4>]:MAXimize <Boolean>`

Command: `DISP:MAX ON` refers to window 1.

In order to refer to a window other than 1, you must include the optional `WINDow` parameter with the suffix for the required window.

`DISP:WIND2:MAX ON` refers to window 2.

Parameters

Parameters must be separated from the header by a "white space". If several parameters are specified in a command, they are separated by a comma (.). For a description of the parameter types, refer to [Chapter 6.3.3, "SCPI Parameters"](#), on page 261.

Example:

Definition: `HCOPY:DEvice:CMAP:COLor:RGB <red>, <green>, <blue>`

Command: `HCOP:DEV:CMAP:COL:RGB 3, 32, 44`

Special characters

	<p>Parameters</p> <p>A vertical stroke in parameter definitions indicates alternative possibilities in the sense of "or". The effect of the command differs, depending on which parameter is used.</p> <p>Example:</p> <p>Definition: <code>HCOPY:PAGE:ORIENTATION LANDscape PORTRait</code></p> <p>Command <code>HCOPY:PAGE:ORI LAND</code> specifies landscape orientation</p> <p>Command <code>HCOPY:PAGE:ORI PORT</code> specifies portrait orientation</p> <p>Mnemonics</p> <p>A selection of mnemonics with an identical effect exists for several commands. These mnemonics are indicated in the same line; they are separated by a vertical stroke. Only one of these mnemonics needs to be included in the header of the command. The effect of the command is independent of which of the mnemonics is used.</p> <p>Example:</p> <p>Definition: <code>SENSE:BANDwidth BWIDTH[:RESolution] <numeric_value></code></p> <p>The two following commands with identical meaning can be created:</p> <p><code>SENS:BAND:RES 1</code></p> <p><code>SENS:BWID:RES 1</code></p>
[]	<p>Mnemonics in square brackets are optional and may be inserted into the header or omitted.</p> <p>Example: <code>HCOPY[:IMMEDIATE]</code></p> <p><code>HCOP:IMM</code> is equivalent to <code>HCOP</code></p>
{ }	<p>Parameters in curly brackets are optional and can be inserted once or several times, or omitted.</p> <p>Example: <code>SENSe:LIST:FREQuency <numeric_value>{,<numeric_value>}</code></p> <p>The following are valid commands:</p> <p><code>SENS:LIST:FREQ 10</code></p> <p><code>SENS:LIST:FREQ 10,20</code></p> <p><code>SENS:LIST:FREQ 10,20,30,40</code></p>

6.3.3 SCPI Parameters

Many commands are supplemented by a parameter or a list of parameters. The parameters must be separated from the header by a "white space" (ASCII code 0 to 9, 11 to 32 decimal, e.g. blank). Allowed parameters are:

- Numeric values
- Special numeric values
- Boolean parameters
- Text
- Character strings
- Block data

The parameters required for each command and the allowed range of values are specified in the command description.

Numeric values

Numeric values can be entered in any form, i.e. with sign, decimal point and exponent. Values exceeding the resolution of the instrument are rounded up or down. The mantissa may comprise up to 255 characters, the exponent must lie inside the value range -32000 to 32000. The exponent is introduced by an "E" or "e". Entry of the exponent alone is not allowed. In the case of physical quantities, the unit can be entered.

Allowed unit prefixes are G (giga), MA (mega), MOHM and MHZ (also allowed), K (kilo), M (milli), U (micro) and N (nano). If the unit is missing, the basic unit is used.

Example: `SENS:FREQ:STOP 1.5GHz = SENS:FREQ:STOP 1.5E9`

Units

For physical quantities, the unit can be entered. Allowed unit prefixes are:

- G (giga)
- MA (mega), MOHM, MHZ
- K (kilo)
- M (milli)
- U (micro)
- N (nano)

If the unit is missing, the basic unit is used.

Example:

`SENSe:FREQ:STOP 1.5GHz = SENSe:FREQ:STOP 1.5E9`

Some settings allow relative values to be stated in percent. According to SCPI, this unit is represented by the `PCT` string.

Example:

`HCOP:PAGE:SCAL 90PCT`

Special numeric values

The texts listed below are interpreted as special numeric values. In the case of a query, the numeric value is provided.

- **MIN/MAX**
MINimum and MAXimum denote the minimum and maximum value.
- **DEF**
DEFault denotes a preset value which has been stored in the EPROM. This value conforms to the default setting, as it is called by the `*RST` command.
- **UP/DOWN**
UP, DOWN increases or reduces the numeric value by one step. The step width can be specified via an allocated step command for each parameter which can be set via UP, DOWN.
- **INF/NINF**

INFinity, Negative INFinity (NINF) represent the numeric values 9.9E37 or -9.9E37, respectively. INF and NINF are only sent as instrument responses.

- **NAN**

Not A Number (NAN) represents the value 9.91E37. NAN is only sent as a instrument response. This value is not defined. Possible causes are the division of zero by zero, the subtraction of infinite from infinite and the representation of missing values.

Example:

Setting command: `SENSe:LIST:FREQ MAXimum`

Query: `SENS:LIST:FREQ?`, Response: `3.5E9`



Queries for special numeric values

The numeric values associated to `MAXimum`/`MINimum`/`DEFault` can be queried by adding the corresponding mnemonics to the command. They must be entered following the quotation mark.

Example: `SENSe:LIST:FREQ? MAXimum`

Returns the maximum numeric value as a result.

Boolean Parameters

Boolean parameters represent two states. The "ON" state (logically true) is represented by "ON" or a numeric value 1. The "OFF" state (logically untrue) is represented by "OFF" or the numeric value 0. The numeric values are provided as the response for a query.

Example:

Setting command: `HCOpy:DEV:COL ON`

Query: `HCOpy:DEV:COL?`

Response: `1`

Text parameters

Text parameters observe the syntactic rules for mnemonics, i.e. they can be entered using a short or long form. Like any parameter, they have to be separated from the header by a white space. In the case of a query, the short form of the text is provided.

Example:

Setting command: `HCOpy:PAGE:ORientation LANDscape`

Query: `HCOp:PAGE:ORI?`

Response: `LAND`

Character strings

Strings must always be entered in quotation marks (' or ").

Example:

```
HCOP:ITEM:LABel "Test1" or HCOP:ITEM:LABel 'Test1'
```

Block data

Block data is a format which is suitable for the transmission of large amounts of data. A command using a block data parameter has the following structure:

Example:

```
FORMat:READings:DATA #45168xxxxxxxx
```

The ASCII character # introduces the data block. The next number indicates how many of the following digits describe the length of the data block. In the example the 4 following digits indicate the length to be 5168 bytes. The data bytes follow. During the transmission of these data bytes all end or other control signs are ignored until all bytes are transmitted.

#0 specifies a data block of indefinite length. The use of the indefinite format requires a `NL^END` message to terminate the data block. This format is useful when the length of the transmission is not known or if speed or other considerations prevent segmentation of the data into blocks of definite length.

6.3.4 Overview of Syntax Elements

The following table provides an overview of the syntax elements:

:	The colon separates the mnemonics of a command. In a command line the separating semicolon marks the uppermost command level.
;	The semicolon separates two commands of a command line. It does not alter the path.
,	The comma separates several parameters of a command.
?	The question mark forms a query.
*	The asterisk marks a common command.
'' ..	Quotation marks introduce a string and terminate it (both single and double quotation marks are possible).
#	The hash symbol introduces binary, octal, hexadecimal and block data. <ul style="list-style-type: none"> • Binary: #B10110 • Octal: #O7612 • Hexa: #HF3A7 • Block: #21312
	A "white space" (ASCII-Code 0 to 9, 11 to 32 decimal, e.g. blank) separates the header from the parameters.

6.3.5 Structure of a command line

A command line may consist of one or several commands. It is terminated by one of the following:

- a <New Line>
- a <New Line> with EOI
- an EOI together with the last data byte

Several commands in a command line must be separated by a semicolon ";". If the next command belongs to a different command system, the semicolon is followed by a colon.

Example:

```
MMEM:COPY "Test1", "MeasurementXY";:HCOP:ITEM ALL
```

This command line contains two commands. The first command belongs to the MMEM system, the second command belongs to the HCOP system.

If the successive commands belong to the same system, having one or several levels in common, the command line can be abbreviated. To this end, the second command after the semicolon starts with the level that lies below the common levels. The colon following the semicolon must be omitted in this case.

Example:

```
HCOP:ITEM ALL;:HCOP:IMM
```

This command line contains two commands. Both commands are part of the HCOP command system, i.e. they have one level in common.

When abbreviating the command line, the second command begins with the level below HCOP. The colon after the semicolon is omitted. The abbreviated form of the command line reads as follows:

```
HCOP:ITEM ALL;IMM
```

A new command line always begins with the complete path.

Example:

```
HCOP:ITEM ALL
```

```
HCOP:IMM
```

6.3.6 Responses to Queries

A query is defined for each setting command unless explicitly specified otherwise. It is formed by adding a question mark to the associated setting command. According to SCPI, the responses to queries are partly subject to stricter rules than in standard IEEE 488.2.

- The requested parameter is transmitted without a header.
Example: `HCOP:PAGE:ORI?`, **Response:** `LAND`
- Maximum values, minimum values and all other quantities that are requested via a special text parameter are returned as numeric values.
Example: `SENSe:FREQuency:STOP? MAX`, **Response:** `3.5E9`

- Numeric values are output without a unit. Physical quantities are referred to the basic units or to the units set using the `Unit` command. The response `3.5E9` in the previous example stands for 3.5 GHz.
- Truth values (Boolean values) are returned as 0 (for OFF) and 1 (for ON).

Example:

Setting command: `HCOPY:DEV:COL ON`

Query: `HCOPY:DEV:COL?`

Response: 1

- Text (character data) is returned in a short form.

Example:

Setting command: `HCOPY:PAGE:ORIENTATION LANDscape`

Query: `HCOP:PAGE:ORI?`

Response: LAND

6.4 Command Sequence and Synchronization

IEEE 488.2 defines a distinction between overlapped and sequential commands:

- A sequential command is one which finishes executing before the next command starts executing. Commands that are processed quickly are implemented as sequential commands. Sequential commands are not implemented in the instrument, however the execution time of most commands is so short that they act as sequential commands when sent in different command lines.
- An overlapping command is one which does not automatically finish executing before the next command starts executing. Usually, overlapping commands take longer to process and allow the program to do other tasks while being executed. If overlapping commands do have to be executed in a defined order, e.g. in order to avoid wrong measurement results, they must be serviced sequentially. Keeping the order is called synchronization between the controller and the instrument.

Setting commands within one command line, even though they can be implemented as sequential commands, are not necessarily serviced in the order in which they have been received. To make sure that commands are actually executed in a certain order, each command must be sent in a separate command line.

Example: Commands and queries in one message

The response to a query combined in a program message with commands that affect the queried value is not predictable.

The following commands always return the specified result:

```
:FREQ:STAR 1GHZ;SPAN 100 :FREQ:STAR?
```

Result:

```
1000000000 (1 GHz)
```

Whereas the result for the following commands is not specified by SCPI:

```
:FREQ:STAR 1GHz;STAR?;SPAN 1000000
```

The result could be the value of `START` before the command was sent since the instrument can defer executing the individual commands until a program message terminator is received. The result could also be 1 GHz if the instrument executes commands as they are received.



As a general rule, send commands and queries in different program messages.

Example: Overlapping command with *OPC

The instrument implements `INITiate[:IMMEDIATE]` as an overlapped command. Assuming that `INITiate[:IMMEDIATE]` takes longer to execute than `*OPC`, sending the following command sequence results in initiating a sweep and, after some time, setting the `OPC` bit in the `ESR`:

```
INIT; *OPC.
```

Sending the following commands still initiates a sweep:

```
INIT; *OPC; *CLS
```

However, since the operation is still pending when the instrument executes `*CLS`, forcing it into the "Operation Complete Command Idle" state (OCIS), `*OPC` is effectively skipped. The `OPC` bit is not set until the instrument executes another `*OPC` command.

6.4.1 Preventing Overlapping Execution

To prevent an overlapping execution of commands, one of the commands `*OPC`, `*OPC?` or `*WAI` can be used. All three commands cause a certain action only to be carried out after the hardware has been set. By suitable programming, the controller can be forced to wait for the corresponding action to occur.

Table 6-2: Synchronization using *OPC, *OPC? and *WAI

Command	Action	Programming the controller
*OPC	Sets the Operation Complete bit in the ESR after all previous commands have been executed.	<ul style="list-style-type: none"> Setting bit 0 in the ESE Setting bit 5 in the SRE Waiting for service request (SRQ)
*OPC?	Stops command processing until 1 is returned. This is only the case after the Operation Complete bit has been set in the ESR. This bit indicates that the previous setting has been completed.	Sending *OPC? directly after the command whose processing should be terminated before other commands can be executed.
*WAI	Stops further command processing until all commands sent before *WAI have been executed.	Sending *WAI directly after the command whose processing should be terminated before other commands are executed.

Command synchronization using *WAI or *OPC? is a good choice if the overlapped command takes only little time to process. The two synchronization commands simply block overlapped execution of the command. Append the synchronization command to the overlapping command, for example:

```
SINGLE; *OPC?
```

For time consuming overlapped commands you can allow the controller or the instrument to do other useful work while waiting for command execution. Use one of the following methods:

***OPC with a service request**

1. Set the OPC mask bit (bit no. 0) in the ESE: *ESE 1
2. Set bit no. 5 in the SRE: *SRE 32 to enable ESB service request.
3. Send the overlapped command with *OPC
4. Wait for a service request

The service request indicates that the overlapped command has finished.

***OPC? with a service request**

1. Set bit no. 4 in the SRE: *SRE 16 to enable MAV service request.
2. Send the overlapped command with *OPC?
3. Wait for a service request

The service request indicates that the overlapped command has finished.

Event Status Register (ESE)

1. Set the OPC mask bit (bit no. 0) in the ESE: *ESE 1
2. Send the overlapped command without *OPC, *OPC? or *WAI

3. Poll the operation complete state periodically (by means of a timer) using the sequence: *OPC; *ESR?

A return value (LSB) of 1 indicates that the overlapped command has finished.

6.5 Status Reporting System

The status reporting system stores all information on the current operating state of the instrument, and on errors which have occurred. This information is stored in the status registers and in the error queue.

You can query both with the commands of the [STATus Subsystem](#).

6.5.1 Hierarchy of the Status Registers

The [Figure 6-1](#) shows the hierarchical structure of information in the status registers (ascending from left to right).

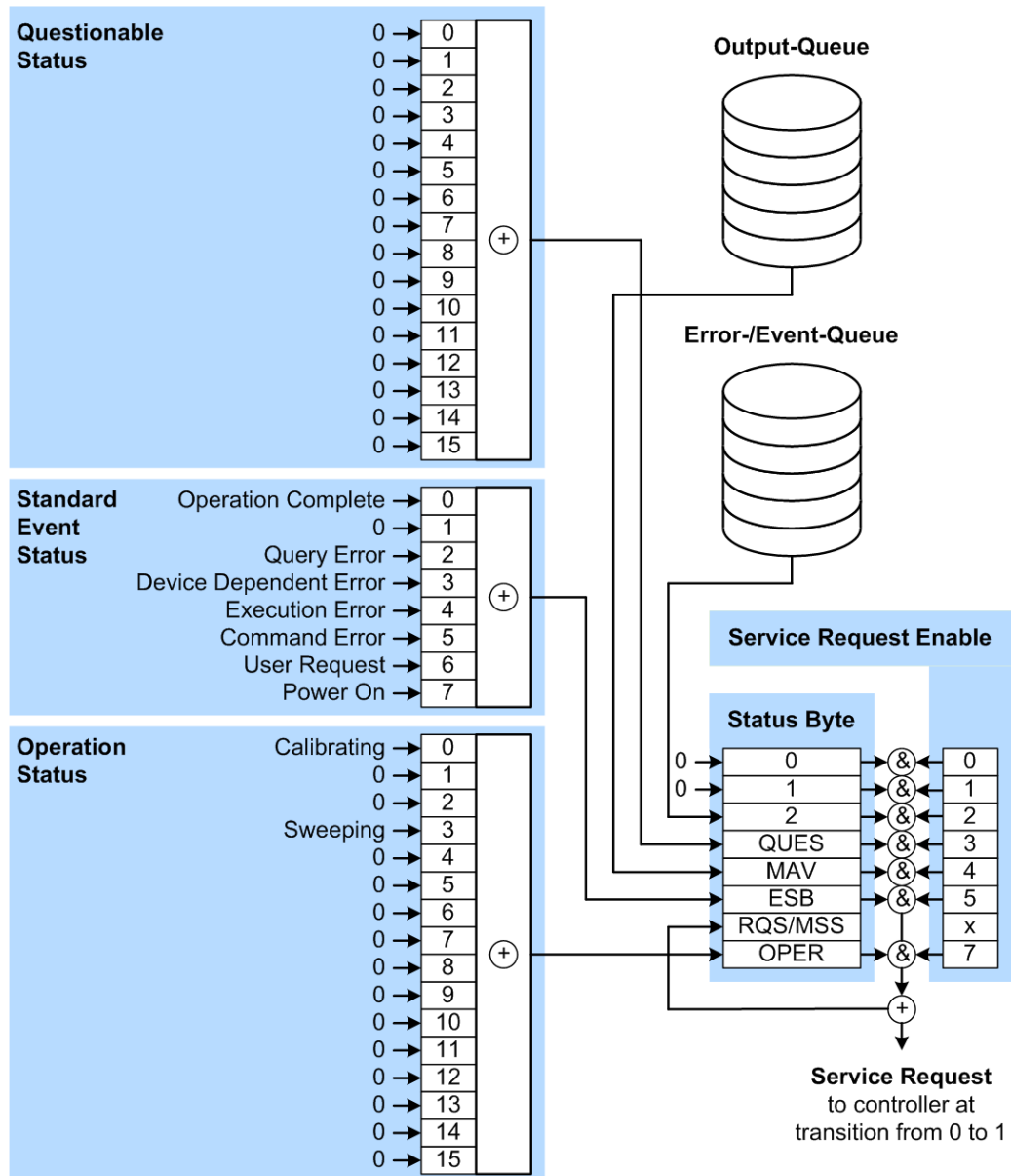

Figure 6-1: Graphical overview of the status registers hierarchy

- OPER = Operation Status Summary Bit
- RQS/MSS = Service Request Generation
- ESB = Standard Event Status Summary Bit
- MAV = Message Available in Output Queue
- QUES = Questionable Status Summary Bit
- 2 = Error- /Event-Queue
- 1, 0 = not used

Note: This legend explains the abbreviations to the Status Byte Register.

The R&S SMB uses the following status registers:

- **Status Byte (STB)** and **Service Request Enable (SRE)**, see [Chapter 6.5.3, "Status Byte \(STB\) and Service Request Enable Register \(SRE\)"](#), on page 273.

- **Standard Event Status**, i.e. the Event status Register (ESR) and the Event Status Enable (ESE), see [Chapter 6.5.4, "Event Status Register \(ESR\) and Event Status Enable Register \(ESE\)"](#), on page 274.
- **Questionable Status and Operation Status**, the (SCPI status registers, see [Chapter 6.5.2, "Structure of a SCPI Status Register"](#), on page 271, [Chapter 6.5.5, "Questionable Status Register \(STATus:QUEStionable\)"](#), on page 274 and [Chapter 6.5.6, "Operation Status Register \(STATus:OPERation\)"](#), on page 275.
- **Output-Queue**
The output queue contains the messages the instrument returns to the controller. It is not part of the status reporting system but determines the value of the MAV bit in the STB and thus is represented in the overview.
- **Error- /Event-Queue**
The error-/event-queue contains all errors and events that have occurred in the past. When reading the queue, the instrument starts with the first occurred error/ event.

All status registers have the same internal structure.



SRE, ESE

The service request enable register SRE can be used as ENABLE part of the STB if the STB is structured according to SCPI. By analogy, the ESE can be used as the ENABLE part of the ESR.

6.5.2 Structure of a SCPI Status Register

Each standard SCPI register consists of 5 parts. Each part has a width of 16 bits and has different functions. The individual bits are independent of each other, i.e. each hardware status is assigned a bit number which is valid for all five parts. Bit 15 (the most significant bit) is set to zero for all parts. Thus the contents of the register parts can be processed by the controller as positive integers.

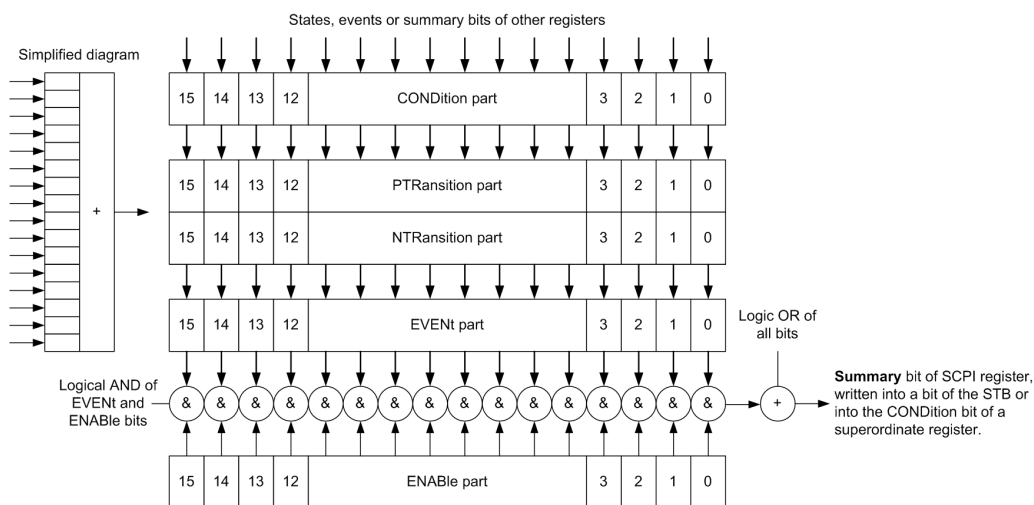

Figure 6-2: The status-register model

Description of the five status register parts

The five parts of a SCPI register have different properties and functions:

- **CONDition**

The `CONDition` part is written into directly by the hardware or the sum bit of the next lower register. Its contents reflect the current instrument status. This register part can only be read, but not written into or cleared. Its contents are not affected by reading.

- **PTRansition / NTRansition**

The two transition register parts define which state transition of the `CONDition` part (none, 0 to 1, 1 to 0 or both) is stored in the `EVENT` part.

The **Positive-TRansition** part acts as a transition filter. When a bit of the `CONDition` part is changed from 0 to 1, the associated `PTR` bit decides whether the `EVENT` bit is set to 1.

- `PTR` bit =1: the `EVENT` bit is set.
- `PTR` bit =0: the `EVENT` bit is not set.

This part can be written into and read as required. Its contents are not affected by reading.

The **Negative-TRansition** part also acts as a transition filter. When a bit of the `CONDition` part is changed from 1 to 0, the associated `NTR` bit decides whether the `EVENT` bit is set to 1.

- `NTR` bit =1: the `EVENT` bit is set.
- `NTR` bit =0: the `EVENT` bit is not set.

This part can be written into and read as required. Its contents are not affected by reading.

- **EVENT**

The `EVENT` part indicates whether an event has occurred since the last reading, it is the "memory" of the condition part. It only indicates events passed on by the transition filters. It is permanently updated by the instrument. This part can only be read by the user. Reading the register clears it. This part is often equated with the entire register.

- **ENABLE**

The `ENABLE` part determines whether the associated `EVENT` bit contributes to the sum bit (see below). Each bit of the `EVENT` part is "ANDed" with the associated `ENABLE` bit (symbol '&'). The results of all logical operations of this part are passed on to the sum bit via an "OR" function (symbol '+').

`ENABLE` bit = 0: the associated `EVENT` bit does not contribute to the sum bit

`ENABLE` bit = 1: if the associated `EVENT` bit is "1", the sum bit is set to "1" as well.

This part can be written into and read by the user as required. Its contents are not affected by reading.

Sum bit

The sum bit is obtained from the `EVENT` and `ENABLE` part for each register. The result is then entered into a bit of the `CONDition` part of the higher-order register.

The instrument automatically generates the sum bit for each register. Thus an event can lead to a service request throughout all levels of the hierarchy.

6.5.3 Status Byte (STB) and Service Request Enable Register (SRE)

The `STatus Byte` (STB) is already defined in IEEE 488.2. It provides a rough overview of the instrument status by collecting the pieces of information of the lower registers. A special feature is that bit 6 acts as the sum bit of the remaining bits of the status byte.

The STB is read using the command `*STB?` or a serial poll.

The `STatus Byte` (STB) is linked to the `Service Request Enable` (SRE) register. Each bit of the STB is assigned a bit in the SRE. Bit 6 of the SRE is ignored. If a bit is set in the SRE and the associated bit in the STB changes from 0 to 1, a service request (SRQ) is generated. The SRE can be set using the command `*SRE` and read using the command `*SRE?`.

Table 6-3: Meaning of the bits used in the status byte

Bit No.	Meaning
0...1	Not used
2	Error Queue not empty The bit is set when an entry is made in the error queue. If this bit is enabled by the SRE, each entry of the error queue generates a service request. Thus an error can be recognized and specified in greater detail by polling the error queue. The poll provides an informative error message. This procedure is to be recommended since it considerably reduces the problems involved with remote control.
3	QUESTionable status register summary bit The bit is set if an <code>EVENT</code> bit is set in the <code>QUESTionable</code> status register and the associated <code>ENABLE</code> bit is set to 1. A set bit indicates a questionable instrument status, which can be specified in greater detail by querying the <code>STATus:QUESTionable</code> status register.
4	MAV bit (message available) The bit is set if a message is available in the output queue which can be read. This bit can be used to enable data to be automatically read from the instrument to the controller.
5	ESB bit Sum bit of the event status register. It is set if one of the bits in the event status register is set and enabled in the event status enable register. Setting of this bit indicates a serious error which can be specified in greater detail by polling the event status register.
6	MSS bit (master status summary bit) The bit is set if the instrument triggers a service request. This is the case if one of the other bits of this registers is set together with its mask bit in the service request enable register SRE.
7	<code>STATus:OPERation</code> status register summary bit The bit is set if an <code>EVENT</code> bit is set in the <code>OPERation</code> status register and the associated <code>ENABLE</code> bit is set to 1. A set bit indicates that the instrument is just performing an action. The type of action can be determined by querying the <code>STATus:OPERation</code> status register.

6.5.4 Event Status Register (ESR) and Event Status Enable Register (ESE)

The ESR is defined in IEEE 488.2. It can be compared with the `EVENT` part of a SCPI register. The event status register can be read out using command `*ESR?`.

The ESE corresponds to the `ENABLE` part of a SCPI register. If a bit is set in the ESE and the associated bit in the ESR changes from 0 to 1, the ESB bit in the STB is set. The ESE register can be set using the command `*ESE` and read using the command `*ESE?`.

Table 6-4: Meaning of the bits used in the event status register

Bit No.	Meaning
0	Operation Complete This bit is set on receipt of the command <code>*OPC</code> exactly when all previous commands have been executed.
1	Not used
2	Query Error This bit is set if either the controller wants to read data from the instrument without having sent a query, or if it does not fetch requested data and sends new instructions to the instrument instead. The cause is often a query which is faulty and hence cannot be executed.
3	Device-dependent Error This bit is set if a device-dependent error occurs. An error message with a number between -300 and -399 or a positive error number, which denotes the error in greater detail, is entered into the error queue.
4	Execution Error This bit is set if a received command is syntactically correct but cannot be performed for other reasons. An error message with a number between -200 and -300, which denotes the error in greater detail, is entered into the error queue.
5	Command Error This bit is set if a command is received, which is undefined or syntactically incorrect. An error message with a number between -100 and -200, which denotes the error in greater detail, is entered into the error queue.
6	User Request This bit is set when the instrument is switched over to manual control.
7	Power On (supply voltage on) This bit is set on switching on the instrument.

6.5.5 Questionable Status Register (STATus:QUESTIONable)

This register contains information on questionable instrument states. Such states may occur when the instrument is not operated in compliance with its specifications.

To read the register, use the query commands `STAT:QUEST:COND?` or `STAT:QUEST[:EVEN]?`.

Table 6-5: Meaning of the bits used in the questionable status register

Bit No.	Meaning
0–15	Not used

6.5.6 Operation Status Register (STATus:OPERation)

This condition part contains information on the actions currently being performed by the instrument, while the event part contains information on the actions performed by the instrument since the last readout of the register.

To read the register, use the query commands `STAT:OPER:COND?` or `STAT:OPER[:EVEN]?`.

Table 6-6: Meaning of the bits used in the operation status register

Bit No.	Meaning
0	Calibrating The bit is set during the calibration phase.
1–2	Not used
3	Sweeping This bit is set during a sweep in automatic or single mode.
4–15	Not used

6.5.7 Application of the Status Reporting System

The purpose of the status reporting system is to monitor the status of one or several devices in a measuring system. To do this and react appropriately, the controller must receive and evaluate the information of all devices. The following standard methods are used:

- **Service request** (SRQ) initiated by the instrument
- **Serial poll** of all devices in the bus system, initiated by the controller to find out who sent an SRQ and why
- Query of a **specific instrument status** by commands
- Query of the **error queue**

6.5.7.1 Service Request

Under certain circumstances, the instrument can send a service request (SRQ) to the controller. Usually this service request initiates an interrupt at the controller, to which the control program can react appropriately. An SRQ is always initiated if one or several of bits 2, 4 or 5 of the status byte are set and enabled in the SRE. Each of these bits combines the information of the error queue or the output buffer. To use the possibilities of the service request effectively, all bits should be set to "1" in the enable registers SRE and ESE.

Example:

Use command `*OPC` to generate an SRQ .

`*ESE 1` - set bit 0 of ESE (Operation Complete)

`*SRE 32` - set bit 5 of SRE (ESB).

After its settings have been completed, the instrument generates an SRQ.

The SRQ is the only possibility for the instrument to become active on its own. Each controller program should set the instrument such that a service request is initiated in the case of malfunction. The program should react appropriately to the service request.

6.5.7.2 Serial Poll

In a serial poll, just as with command `*STB`, the status byte of an instrument is queried. However, the query is realized via interface messages and is thus clearly faster.

The serial poll method is defined in IEEE 488.1 and used to be the only standard possibility for different instruments to poll the status byte. The method also works for instruments which do not adhere to SCPI or IEEE 488.2.

The serial poll is mainly used to obtain a fast overview of the state of several instruments connected to the controller.

6.5.7.3 Query of an instrument status

Each part of any status register can be read using queries. There are two types of commands:

- The common commands `*ESR?`, `*IDN?`, `*IST?`, `*STB?` query the higher-level registers.
- The commands of the `STATus` system query the SCPI registers (`STATus:QUEStionable...`)

The returned value is always a decimal number that represents the bit pattern of the queried register. This number is evaluated by the controller program.

Queries are usually used after an SRQ in order to obtain more detailed information on the cause of the SRQ.

6.5.7.4 Error Queue

Each error state in the instrument leads to an entry in the error queue. The entries of the error queue are detailed plain text error messages that can be looked up in the Error Log or queried via remote control using `SYSTem:ERRor[:NEXT]?`. Each call of `SYSTem:ERRor[:NEXT]?` provides one entry from the error queue. If no error messages are stored there any more, the instrument responds with 0, "No error".

The error queue should be queried after every SRQ in the controller program as the entries describe the cause of an error more precisely than the status registers. Especially in the test phase of a controller program the error queue should be queried regu-

larly since faulty commands from the controller to the instrument are recorded there as well.

6.5.8 Reset Values of the Status Reporting System

The following table contains the different commands and events causing the status reporting system to be reset. None of the commands, except of *RST and SYSTem:PRESet affect the functional instrument settings. In particular, DCL does not change the instrument settings.

Table 6-7: Resetting the status reporting system

Event	Switching on supply voltage Power-On-Status-Clear		DCL, SDC (Device Clear, Selected Device Clear)	*RST or SYSTem: PRESet	STATus: PRESet	*CLS
	0	1				
Clear STB, ESR	-	Yes	-	-	-	Yes
Clear SRE, ESE	-	Yes	-	-	-	-
Clear PPE	-	Yes	-	-	-	-
Clear error queue	Yes	Yes	-	-	-	Yes
Clear output buffer	Yes	Yes	Yes	1)	1)	1)
Clear command processing and input buffer	Yes	Yes	Yes	-	-	-

1) The first command in a command line that immediately follows a <PROGRAM MESSAGE TERMINATOR> clears the output buffer.

6.6 General Programming Recommendations

Initial instrument status before changing settings

Manual operation is designed for maximum possible operating convenience. In contrast, the priority of remote control is the "predictability" of the instrument status. Thus, when a command attempts to define incompatible settings, the command is ignored and the instrument status remains unchanged, i.e. other settings are not automatically adapted. Therefore, control programs should always define an initial instrument status (e.g. using the *RST command) and then implement the required settings.

Command sequence

As a general rule, send commands and queries in different program messages. Otherwise, the result of the query may vary depending on which operation is performed first (see also Preventing Overlapping Execution).

Reacting to malfunctions

The service request is the only possibility for the instrument to become active on its own. Each controller program should instruct the instrument to initiate a service request in case of malfunction. The program should react appropriately to the service request.

Error queues

The error queue should be queried after every service request in the controller program as the entries describe the cause of an error more precisely than the status registers. Especially in the test phase of a controller program the error queue should be queried regularly since faulty commands from the controller to the instrument are recorded there as well.

7 Remote Control Commands

In the following, all remote-control commands will be presented in detail with their parameters and the ranges of numerical values.

For an introduction to remote control and the status registers, refer to [Chapter 6, "Remote Control Basics"](#), on page 235.

7.1 Conventions used in SCPI Command Descriptions

Note the following conventions used in the remote command descriptions:

- **Command usage**
If not specified otherwise, commands can be used both for setting and for querying parameters.
If a command can be used for setting or querying only, or if it initiates an event, the usage is stated explicitly.
- **Parameter usage**
If not specified otherwise, a parameter can be used to set a value and it is the result of a query.
Parameters required only for setting are indicated as **Setting parameters**.
Parameters required only to refine a query are indicated as **Query parameters**.
Parameters that are only returned as the result of a query are indicated as **Return values**.
- **Conformity**
Commands that are taken from the SCPI standard are indicated as **SCPI confirmed**. All commands used by the R&S SMB follow the SCPI syntax rules.
- **Asynchronous commands**
A command which does not automatically finish executing before the next command starts executing (overlapping command) is indicated as an **Asynchronous command**.
- **Reset values (*RST)**
Default parameter values that are used directly after resetting the instrument (*RST command) are indicated as ***RST** values, if available.
- **Default unit**
This is the unit used for numeric values if no other unit is provided with the parameter.
- **Manual operation**
If the result of a remote command can also be achieved in manual operation, a link to the description is inserted.

7.2 Common Commands

Common commands are described in the IEEE 488.2 (IEC 625-2) standard. These commands have the same effect and are employed in the same way on different devi-

ces. The headers of these commands consist of "*" followed by three letters. Many common commands are related to the Status Reporting System.

Available common commands:

*CLS.....	280
*ESE.....	280
*ESR?.....	280
*IDN?.....	281
*IST?.....	281
*OPC.....	281
*OPT?.....	281
*PRE.....	282
*PSC.....	282
*RCL.....	282
*RST.....	282
*SAV.....	283
*SRE.....	283
*STB?.....	283
*TRG.....	283
*TST?.....	283
*WAI.....	284

*CLS

Clear status

Sets the status byte (STB), the standard event register (ESR) and the `EVENT` part of the `QUESTIONABLE` and the `OPERATION` registers to zero. The command does not alter the mask and transition parts of the registers. It clears the output buffer.

Usage: Setting only

*ESE <Value>

Event status enable

Sets the event status enable register to the specified value. The query returns the contents of the event status enable register in decimal form.

Parameters:

<Value> Range: 0 to 255

*ESR?

Event status read

Returns the contents of the event status register in decimal form and subsequently sets the register to zero.

Return values:

<Contents> Range: 0 to 255

Usage: Query only

*IDN?

Identification

Returns the instrument identification.

Return values:

<ID> "Rohde&Schwarz,<device type>,<serial number>,<firmware version>"

Example: Rohde&Schwarz,SMB,
1407.6004k02/000000,3.1.17.1-03.01.158

Usage: Query only

Manual operation: See "[Hardware Options / Software Options](#)" on page 96

*IST?

Individual status query

Returns the contents of the IST flag in decimal form. The IST flag is the status bit which is sent during a parallel poll.

Return values:

<ISTflag> 0 | 1

Usage: Query only

*OPC

Operation complete

Sets bit 0 in the event status register when all preceding commands have been executed. This bit can be used to initiate a service request. The query form writes a "1" into the output buffer as soon as all preceding commands have been executed. This is used for command synchronization.

*OPT?

Option identification query

Queries the options included in the instrument. For a list of all available options and their description refer to the data sheet.

Return values:

<Options> The query returns a list of options. The options are returned at fixed positions in a comma-separated string. A zero is returned for options that are not installed.

Usage: Query only

Manual operation: See "[Hardware Options / Software Options](#)" on page 96

***PRE** <Value>

Parallel poll register enable

Sets parallel poll enable register to the indicated value. The query returns the contents of the parallel poll enable register in decimal form.

Parameters:

<Value> Range: 0 to 255

***PSC** <Action>

Power on status clear

Determines whether the contents of the `ENABLE` registers are preserved or reset when the instrument is switched on. Thus a service request can be triggered when the instrument is switched on, if the status registers ESE and SRE are suitably configured. The query reads out the contents of the "power-on-status-clear" flag.

Parameters:

<Action> 0 | 1

0

The contents of the status registers are preserved.

1

Resets the status registers.

***RCL** <Number>

Recall

Loads the instrument settings from an intermediate memory identified by the specified number. The instrument settings can be stored to this memory using the command [*SAV](#) with the associated number.

It also activates the instrument settings which are stored in a file and loaded using the `MMEMory:LOAD <number>, <file_name.extension>` command.

Manual operation: See "[Recall](#)" on page 129

***RST**

Reset

Sets the instrument to a defined default status. The default settings are indicated in the description of commands.

The command is equivalent to `SYSTem:PRESet`.

Usage: Setting only

Manual operation: See "[Preset](#)" on page 91

***SAV** <Number>

Save

Stores the current instrument settings under the specified number in an intermediate memory. The settings can be recalled using the command ***RCL** with the associated number.

To transfer the stored instrument settings in a file, use the command **:MMEMory:STORe:STATe**.

Manual operation: See "Save" on page 128

***SRE** <Contents>

Service request enable

Sets the service request enable register to the indicated value. This command determines under which conditions a service request is triggered.

Parameters:

<Contents> Contents of the service request enable register in decimal form.
Bit 6 (MSS mask bit) is always 0.
Range: 0 to 255

***STB?**

Status byte query

Reads the contents of the status byte in decimal form.

Usage: Query only

***TRG**

Trigger

Triggers all actions waiting for a trigger event. In particular, ***TRG** generates a manual trigger signal. This common command complements the commands of the **TRIGger** subsystem.

Usage: Event

Manual operation: See "Execute Single Trigger" on page 229

***TST?**

Self-test query

Initiates self-tests of the instrument and returns an error code

Return values:

<ErrorCode> **integer > 0 (in decimal format)**
 An error occurred.
 (For details see the Service Manual supplied with the instrument).

0
 No errors occurred.

Usage: Query only

***WAI**

Wait to continue

Prevents servicing of the subsequent commands until all preceding commands have been executed and all signals have settled (see also command synchronization and [*OPC](#)).

Usage: Event

7.3 Preset Commands

The preset commands are not bundled in one subsystem. Therefore, they are listed separately in this section. In addition, a specific preset command is provided for each digital standard and for the fader. These specific commands are described in the associated subsystems.

Four presetting actions are available:

- Activating the default state of all internal instrument functions ([*RST](#) on page 282). Functions that concern the integration of the instrument into a measurement setup are not changed, e.g. GPIB address or reference oscillator source settings.
- Activating the preset state of the parameters related to the selected signal path ([:SOURCE<hw>:PRESet](#) on page 285)
- Activating the preset state of all parameters that are not related to the signal path ([:DEVICE:PRESet](#) on page 284)
- Activating the original state of delivery (factory reset, [:SYSTEM:FPreSet](#) on page 285). Only functions that are protected by a password remain unchanged as well as the passwords themselves.

:DEVICE:PRESet

Presets all parameters which are not related to the signal path, including the LF generator.

Example: Presets all instruments settings that are not related to the signal path

Usage: Event

:SOURce<hw>:PRESet

Presets all parameters which are related to the selected signal path.

The following functions are only preset by command *RST: Fading, transient recorder.

Example: SOUR: PRES
Presets all settings that are related to signal path

Usage: Event

:SYSTem:PRESet

Triggers an instrument reset. It has the same effect as:

- The PRESET key
- The *RST command

For an overview of the settings affected by the preset function, see [Chapter 5.2.2, "Default Instrument Settings - Preset Key"](#), on page 91.

Example: SYST: PRES
All instrument settings (also the settings that are not currently active) are reset to their default values.

Usage: Setting only

:SYSTem:FPReset

Triggers an instrument reset to the original state of delivery.

Note: "Factory Preset" resets the "Remote Channel" and network settings to the default values.

Executing "Factory Preset" via remote control terminates the connection to the instrument, if these settings had been configured to values different to the default ones.

The factory preset function resets nearly all instrument settings. In addition to the regular preset by means of the PRESET key, a "Factory Preset" resets also the following values:

- Reference frequency settings ("Ref Oscillator" menu)
- Power on settings ("Level/EMF" menu)
- Network settings including hostname ("Setup" menu)
- Remote channel settings including GPIB address ("Setup" menu)
- Start/Stop display update ("Setup" menu)
- Display and keyboard settings ("Setup" menu).

To maintain security, password settings and all settings protected by these passwords like disabled USB and LAN connections are not changed.

Not affected by the "Factory Preset" are also user data, lists or instrument settings files, created for example by means of the Save/Recall function.

Example:	<code>SYST:FPR</code> All instrument settings (also the settings that are not currently active) are reset to the factory values.
Usage:	Event
Manual operation:	See "Factory Preset" on page 120

7.4 CALibration Subsystem

The CALibration system contains the commands for adjustment. Adjustment is triggered by the query commands. The response "0" indicates error-free adjustment, and the response "1" means that an error occurred during adjustment.

<code>:CALibration<hw>:ALL[:MEASure]?</code>	286
<code>:CALibration<hw>:FMOFfset[:MEASure]?</code>	286
<code>:CALibration<hw>:FREQuency[:MEASure]?</code>	287
<code>:CALibration<hw>:LEVel[:MEASure]?</code>	287
<code>:CALibration<hw>:LEVel:EXTErn:DATA</code>	287
<code>:CALibration<hw>:ROSCillator[:DATA]</code>	288
<code>[:SOURce]:CALibration:STEReo:ANALog[:MEAS]?</code>	288

`:CALibration<hw>:ALL[:MEASure]?` [`<Force>`]

Starts all internal adjustments that do not require external measurement equipment.

Query parameters:

`<Force>` string

Return values:

`<Measure>` select

Example:

```
CAL:ALL:MEAS?
// Response "0"
// Adjustment has been performed successfully
```

Usage: Query only

Manual operation: See "Adjust All" on page 93

`:CALibration<hw>:FMOFfset[:MEASure]?`

The command starts all adjustment for the FM/PhiM modulator.

Return values:

`<Measure>` 0 | 1

Example:

```
CAL:FMOF?
starts the adjustments for the FM/Phim modulator.
Response: "0"
the adjustments have been performed successfully
```

Usage: Query only

Manual operation: See ["Adjust FM Offset"](#) on page 205

:CALibration<hw>:FREQuency[:MEASure]?

Starts all adjustments which affect the frequency.

Return values:

<Measure> 0 | 1

Example:

CAL:FREQ:MEAS?

starts the adjustments for maximum frequency accuracy.

Response: "0"

the adjustments have been performed successfully.

Usage:

Query only

Manual operation: See ["Adjust Synthesis"](#) on page 93

:CALibration<hw>:LEVel[:MEASure]? [<Force>]

Starts all adjustments which affect the level.

The acquired correction values improve the settling time and the signal quality.

Query parameters:

<Force> string
*RST: force

Return values:

<Measure> 0 | 1

Example:

CAL:LEV:MEAS?

starts adjustments for maximum level accuracy.

Response: "0"

adjustment has been performed successfully.

Usage:

Query only

Manual operation: See ["Adjust Level"](#) on page 94

:CALibration<hw>:LEVel:EXTErn:DATA <Data>

Queries what data has been used for the level calibration.

By default the instrument uses correction data obtained in the factory before delivery. In addition, customer data can be used for external level correction. The customer data is obtained using a R&S NRP power sensor. External level correction is a protected function (see service manual, chapter 2, "Adjustment").

Parameters:

<Data> FACTory | CUSTomer
*RST: FACTory

Example: `CAL:LEV:EXT:DATA FACT`
selects the use of the data acquired at the factory for external level correction.

Manual operation: See "[Adjustment Data](#)" on page 151

:CALibration<hw>:ROSCillator[:DATA] <Data>

Sets the calibration value for the custom defined external adjustment.

Parameters:

<Data> integer
Range: 0 to INT_MAX
*RST: 0

[:SOURce]:CALibration:STEReo:ANALog[:MEAS]?

The command starts all adjustments which affect the analog channels of the stereo coder option.

Return values:

<Meas> 0 | 1

Example: `CAL:STER:ANAL?`
starts the adjustments for analog channels of the stereo coder.
Response: 0
the adjustments have been performed successfully.

Usage: Query only

Options: R&S SMB-B5

Manual operation: See "[Adjust Stereo Coder](#)" on page 94

7.5 DIAGnostic Subsystem

The `DIAGnostic` system contains the commands used for instrument diagnosis and servicing. SCPI does not define any `DIAGnostic` commands; the commands listed here are all device-specific. All `DIAGnostic` commands are query commands which are not influenced by `*RST`.

:DIAGnostic<hw>:BGINfo?	288
:DIAGnostic<hw>:BGINfo:CATalog?	289
:DIAGnostic:INFO:OTIMe?	289
:DIAGnostic:INFO:POCount?	290

:DIAGnostic<hw>:BGINfo? [<Board>]

Checks the modules available in the instrument using the variant and revision state.

If the command is sent without parameters being specified, a complete list of all modules is returned (the various entries are separated by commas). The length of the list is variable and depends on the instrument equipment configuration.

If the command is sent with parameters, a list of the specified modules is returned (the various entries are separated by commas). A list of modules names can be called up using the command `:DIAGnostic<hw>:BGInfo:CATalog?` on page 289.

Query parameters:

<Board> string

Return values:

<BgInfo> <Module name> <Module stock number incl. variant> <Module revision> <Module serial number>

Each entry for one module consists of four parts which are separated by space characters.

Example:

DIAG:BGIN

Queries the instrument configuration.

Returns the data of all available modules.

DIAG:BGIN? 'MBRD'

Queries the configuration of the motherboard.

Response: MBRD 1141.3501.02 1.5.3 100023

Module motherboard with part number 1141.3501.01 has revision 1.5.3 and serial number 100023.

Usage: Query only

Manual operation: See "[Assembly](#)" on page 95

:DIAGnostic<hw>:BGInfo:CATalog?

Queries the names of the assemblies available in the instrument.

Return values:

<Catalog> string

A complete list of all assemblies is returned (the various entries are separated by commas). The length of the list is variable and depends on the instrument equipment configuration.

Example:

DIAG:BGIN:CAT

Queries the names of the assemblies.

Usage: Query only

:DIAGnostic:INFO:OTIME?

The command queries the number of operation hours.

Return values:

<OTIME> float

Example: DIAG:INFO:OTIM
 queries the operation hours.
 Response: 100023
 The instrument was operated for 100023 hours up to now.

Usage: Query only

Manual operation: See "[Operation Time / h](#)" on page 94

:DIAGnostic:INFO:POCount?

The command queries the number of power-on events.

Return values:

<Pocount> float

Example: DIAG:INFO:POC
 queries the number of power on events.
 Response: 123
 The instrument was switched on for 123 times up to now.

Usage: Query only

Manual operation: See "[Power On Count](#)" on page 95

7.6 DISPlay Subsystem

The DISPlay subsystem contains the commands to set the power-save mode of the instrument.

:DISPlay:ANNotation:AMPLitude	290
:DISPlay:ANNotation:FREQuency	291
:DISPlay:ANNotation[:ALL]	291
:DISPlay:DIALog:CLOSe	291
:DISPlay:DIALog:CLOSe:ALL	291
:DISPlay:DIALog:ID?	291
:DISPlay:DIALog:OPEN	292
:DISPlay:PSAVe:HOLDoff	292
:DISPlay:PSAVe[:STATe]	292
:DISPlay:UPDate	293

:DISPlay:ANNotation:AMPLitude <State>

Indicates asterisks instead of the level values in the status bar.

Parameters:

<State> 0 | 1 | OFF | ON
 *RST: 1

Example: DISP:ANN:AMPL ON
 Suppresses the level display.

Manual operation: See "Annotation Amplitude" on page 118

:DISPlay:ANNotation:FREQuency <State>

Indicates asterisks instead of the frequency values in the status bar.

Parameters:

<State> 0 | 1 | OFF | ON
 *RST: 1

Example: DISP:ANN:FREQ ON
 Suppresses the frequency display.

Manual operation: See "Annotation Frequency" on page 118

:DISPlay:ANNotation[:ALL] <State>

Displays asterisks instead of the level and frequency values in the status bar of the instrument. This setting is useful when you remotely control the instrument.

Parameters:

<State> 0 | 1 | OFF | ON
 *RST: 1

Example: DISP:ANN:AMPL ON
 Shows asterisks instead of frequency and level values.

:DISPlay:DIALog:CLOSe <DialogId>

Closes the specified dialog. To determine the dialog identifier, use command : [DISPlay:DIALog:ID?](#).

Setting parameters:

<DialogId> string

Example: DISP:DIAL:CLOS "<dialog ID>"
 Closes the dialog, determined with the "<dialog ID>".

Usage: Setting only

:DISPlay:DIALog:CLOSe:ALL

Closes all open dialogs.

Example: DISP:DIAL:CLOS:ALL

Usage: Event

:DISPlay:DIALog:ID?

Returns the dialog identifiers of the open dialogs in a string separated by blanks.

Return values:

<DialogIdList> string

Example:

DISP:DIAL:ID?

Response: "<dialog ID(1)> <dialog ID(2)> ...
<dialog ID(n)>"

Returns the dialog identifiers of all opened dialogs.

Usage:

Query only

:DISPlay:DIALog:OPEN <DialogId>

Opens the specified dialog. To determine the dialog identifier, use command :
[DISPlay:DIALog:ID?](#).

Setting parameters:

<DialogId> string

Example:

DISP:DIAL:OPEN "<dialog ID>"

Opens the dialog, determined with the "<dialog ID>".

Usage:

Setting only

:DISPlay:PSAVe:HOLDoff <HoldoffTimeMin>

Sets the waiting time for the screen-save mode of the display.

Parameters:

<HoldoffTimeMin> integer

Range: 1 to 60

*RST: 10

Default unit: minute

Example:

DISP:PSAV:HOLD 8

Sets the timeout of the screen saver to 8 minutes.

Manual operation: See "[Wait Time](#)" on page 108

:DISPlay:PSAVe[:STATe] <State>

Activates the screen-save mode of the display.

If activated, the display including backlight is switched off after the wait time elapses and if no entries via front panel, external mouse or external keyboard are made. To set the wait time, use command :[DISPlay:PSAVe:HOLDoff](#).

This mode is recommended for protecting the display, especially if you operate the instrument via remote control.

Parameters:

<State> 0 | 1 | OFF | ON

*RST: 0

Example: DISP:PSAV ON
Activates screen saver mode.

Manual operation: See "[Screen Saver Active](#)" on page 108

:DISPlay:UPDate <Update>

Activates the refresh mode of the display.

Parameters:

<Update> 0 | 1 | OFF | ON
*RST: 1

Example: DISP:UPD ON
Activates automatic update of the display at defined time intervals.

7.7 FORMat Subsystem

The FORMat subsystem contains the commands which determine the format of the data that the R&S SMB returns to the controller. This affects all query commands which return a list of numerical data or block data. Reference is made to this in the descriptions of the commands.

:FORMat:BORDER	293
:FORMat[DATA]	294
:FORMat:SREGister	294

:FORMat:BORDER <Border>

Determines the sequence of bytes within a binary block. This only affects blocks which use the IEEE754 format internally.

Parameters:

<Border> NORMal | SWAPped

NORMal

The instrument expects (with setting commands) and sends (with queries) the least significant byte of each IEEE754 floating-point number first and the most significant byte last.

SWAPped

The instrument expects (with setting commands) and sends (with queries) the most significant byte of each IEEE754 floating-point number first and the least significant byte last.

*RST: NORMal

Example: FORM:BORD SWAP
The data is transferred with the most significant bit first.

:FORMat[:DATA] <Data>

Determines the data format which the R&S SMB uses to return data. When data is transferred from the control computer to the instrument, the instrument detects the data format automatically. In this case, the value set here is irrelevant.

Parameters:

<Data> ASCII | PACKed

ASCII

Numerical data is transferred as plain text separated by commas.

PACKed

Numerical data is transferred as binary block data. The format within the binary data depends on the command. The various binary data formats are explained in the description of the parameter types.

*RST: ASCII

Example:

FORM ASC

The data is transferred as ASCII data.

:FORMat:SREGister <Format>

Determines the numerical format which is returned when the status registers are queried.

Parameters:

<Format> ASCII | BINary | HEXadecimal | OCTal

ASCII

The register content is returned as a decimal number.

BINary

The register content is returned as a binary number. #B is placed in front of the number.

HEXadecimal

The register content is returned as a hexadecimal number. #H is placed in front of the number.

OCTal

The register content is returned as an octal number. #Q is placed in front of the number.

*RST: ASCII

Example:

FORM:SREG HEX

The register content is returned as a hexadecimal number.

7.8 HCOPY Subsystem

The `HCOPY` subsystem contains the commands to generate a hardcopy of the display.

:HCOPY:DATA?	295
:HCOPY:DEvice	295
:HCOPY:DEvice:LANGUage	296
:HCOPY[:EXECute]	296
:HCOPY:FILE[:NAME]	296
:HCOPY:FILE[:NAME]:AUTO?	297
:HCOPY:FILE[:NAME]:AUTO:DIRectory	297
:HCOPY:FILE[:NAME]:AUTO:DIRectory:CLEar	297
:HCOPY:FILE[:NAME]:AUTO:FILE?	297
:HCOPY:FILE[:NAME]:AUTO[:FILE]:DAY?	298
:HCOPY:FILE[:NAME]:AUTO[:FILE]:DAY:STATe	298
:HCOPY:FILE[:NAME]:AUTO[:FILE]:MONTH?	299
:HCOPY:FILE[:NAME]:AUTO[:FILE]:MONTH:STATe	299
:HCOPY:FILE[:NAME]:AUTO[:FILE]:NUMBer?	299
:HCOPY:FILE[:NAME]:AUTO[:FILE]:PREFix	300
:HCOPY:FILE[:NAME]:AUTO[:FILE]:PREFix:STATe	300
:HCOPY:FILE[:NAME]:AUTO[:FILE]:YEAR?	300
:HCOPY:FILE[:NAME]:AUTO[:FILE]:YEAR:STATe	300
:HCOPY:FILE[:NAME]:AUTO:STATe	301
:HCOPY:IMAGe:FORMat	301
:HCOPY:IMAGe:SIZE	301

:HCOPY:DATA?

Transfers the hardcopy data directly as a NByte stream to the remote client.

Return values:

<Data> block data

Example:

```
HCOP:DEV:LANG JPG
HCOP:DATA?
```

Transfers the hardcopy to the remote client.

Usage:

Query only

:HCOPY:DEvice <Device>

Defines the output device. The hardcopy can be output in a file. The `HCOPY:FILE:...` commands are used for configuration. The file is accessible using the `MMEM:..` commands. In addition, the hardcopy data can be directly transferred to the remote client using command `:HCOPY:DATA?`.

Parameters:

<Device> FILE
 *RST: FILE

Example:

```
HCOP:DEV FILE
```

The hardcopy is stored in a file.

Manual operation: See "[Destination](#)" on page 122

:HCOPY:DEVIce:LANGUage <Language>

Selects the bitmap graphic format for the screenshot.

You can also retrieve the data using command `HCOPY:DATA?`. This command is an alias to command `HCOPY:IMAGe:FORMAt`.

Parameters:

<Language> BMP | JPG | XPM | PNG
*RST: PNG

Example:

```
HCOPY:DEV:LANG BMP
Selects bitmap as image format.
HCOPY:FILE '/usb/HCopy'
Defines the directory, path and filename for storing the hard-
copy.
HCOPY
Triggers the hardcopy generation.
```

Manual operation: See ["File Options"](#) on page 123

:HCOPY[:EXECute]

Triggers the generation of a hardcopy.

Example: `HCOPY`
Triggers the generation of a hardcopy of the current display.

Usage: Event

Manual operation: See ["Save"](#) on page 125

:HCOPY:FILE[:NAME] <Name>

Creates/selects a file into which the hardcopy is stored.

The path is specified together with the filename. Access to the file via remote control is possible using the commands of the `MMEM` subsystem. In contrast, command `HCOPY:DATA?` transfers the hardcopy contents directly to the remote client where they can be further processed.

If automatic file naming is activated, the hardcopy is stored into a file with an automatically generated name (commands `HCOPY:FILE[:NAME]:AUTO:...`).

Parameters:

<Name> string

Example: `HCOPY:FILE:NAME '/usb/HCopy'`
Defines the hardcopy filename.

Manual operation: See ["File Info"](#) on page 123

:HCOPY:FILE[:NAME]:AUTO?

Queries the path including the filename of the file with automatically generated name.

Return values:

<Auto> string

Example: See `:HCOPY:FILE[:NAME]:AUTO:FILE?` on page 297

Usage: Query only

Manual operation: See "File Options" on page 123

:HCOPY:FILE[:NAME]:AUTO:DIRectory <Directory>

Sets the directory into which the hardcopy files are stored if auto naming is activated (`HCOPY:FILE:AUTO:STAT ON`). The directory is created if it does not exist yet.

Parameters:

<Directory> string
*RST: .\HCopy

Example: `HCOPY:FILE:AUTO:DIR ' /usb/ '`
Defines the destination directory '/usb/'

Manual operation: See "File Options" on page 123

:HCOPY:FILE[:NAME]:AUTO:DIRectory:CLEar

Deletes all files with extensions "bmp", "img", "png" and "xpm" in the directory set for automatic naming.

Example: `HCOPY:FILE:AUTO:DIR:CLE`
Deletes all image files with extensions "bmp", "img", "png" and "xpm".

Usage: Event

Manual operation: See "File Options" on page 123

:HCOPY:FILE[:NAME]:AUTO:FILE?

Queries the filename that what generated using the automatic naming settings. By default the automatically generated filename is composed of:

<Prefix><YYYY><MM><DD><Number>.<Format>.

Each component can be deactivated/activated separately.

Return values:

<File> string

Example: HCOP:DEV:LANG BMP
 Selects output format *.bmp.
 HCOP:FILE:AUTO:DIR '/usb/'
 Defines the destination directory '/usb/'
 HCOP:FILE:AUTO:PREF 'gen'
 The filename starts with the prefix 'gen'. The usage of automatic naming with prefix and date in the filename is preset (...:STAT ON).
 HCOP
 Triggers the generation of a hardcopy of the current trace.
 HCOP:FILE:AUTO?
 Queries the path including the filename
 Response:
 /usb/gen101012008001.bmp'
 HCOP:FILE:AUTO:FILE?
 Queries the filename
 Response: 'gen101012008001.bmp'

Usage: Query only

Manual operation: See "[File Info](#)" on page 123

:HCOPY:FILE[:NAME]:AUTO[:FILE]:DAY?

Queries the day of the current system date which is used in the filename if automatic naming is activated.

Return values:

<Day> integer
 Range: 1 to 31
 *RST: 1

Example: HCOP:FILE:AUTO:DAY?
 Returns the day in the date part of the automatic filename.

Usage: Query only

:HCOPY:FILE[:NAME]:AUTO[:FILE]:DAY:STATe <State>

Activates the usage of the day in the automatic filename.

Parameters:

<State> 0 | 1 | OFF | ON
 *RST: 1

Example: HCOP:FILE:AUTO:DAY:STAT OFF
 Deactivates the use of the day in the automatically generated filename.

Manual operation: See "[File Options](#)" on page 123

:HCOpy:FILE[:NAME]:AUTO[:FILE]:MONTH?

Queries the month in the date part in the automatic filename.

Return values:

<Month> integer
Range: 1 to 12
*RST: 1

Example: HCOpy:FILE:AUTO:MONT?
Queries the month in the date part in the automatic filename.

Usage: Query only

:HCOpy:FILE[:NAME]:AUTO[:FILE]:MONTH:STATe <State>

Activates the usage of the month in the automatic filename.

Parameters:

<State> 0 | 1 | OFF | ON
*RST: 1

Example: HCOpy:FILE:AUTO:MONT:STAT OFF
Deactivates the usage of the month in the automatic filename.

Manual operation: See "[File Options](#)" on page 123

:HCOpy:FILE[:NAME]:AUTO[:FILE]:NUMBer?

Queries the number in the automatic filename. The number is assigned in such a way that always the lowest possible value for a unique filename within the selected path is used.

On initially switching on the device, the number is reset to the lowest possible value. Starting with number 0 the output directory is scanned for existing files. As long as files with the same name are existing, the number is incremented by 1. The number is automatically set to a number so that the resulting filename is unique within the selected path. The current number is not saved in the save recall file but is temporarily stored within the database. On subsequent saves, the number is incremented.

Return values:

<Number> integer
Range: 0 to 999999
*RST: 0

Example: HCOpy:FILE:AUTO:NUMB?
Queries the number in the automatic filename.

Usage: Query only

Manual operation: See "[File Options](#)" on page 123

:HCOPY:FILE[:NAME]:AUTO[:FILE]:PREFIX <Prefix>

Sets the prefix part in the automatic filename. The usage of the prefix is activated with command `HCOPY:FILE:AUTO:PREFIX:STAT ON`.

Parameters:

<Prefix> string
 *RST: HCopy

Example: `HCOPY:FILE:AUTO:PREFIX 'Snapshot'`
 Appends "Snapshot" as prefix to the generated filename.

Manual operation: See "File Options" on page 123

:HCOPY:FILE[:NAME]:AUTO[:FILE]:PREFIX:STATE <State>

Activates the usage of the prefix in the automatic filename. The prefix is entered with command `HCOPY:FILE:AUTO:PREFIX`.

Parameters:

<State> 0 | 1 | OFF | ON
 *RST: 1

Example: `HCOPY:FILE:AUTO:PREFIX:STAT OFF`
 Deactivates the usage of the prefix in the automatic filename.

Manual operation: See "File Options" on page 123

:HCOPY:FILE[:NAME]:AUTO[:FILE]:YEAR?

Queries the year in the date part in the automatic filename.

Return values:

<Year> integer
 Range: 1784 to 8000
 *RST: 0

Example: `HCOPY:FILE:AUTO:YEAR?`
 Queries the year in the date part in the automatic filename.

Usage: Query only

:HCOPY:FILE[:NAME]:AUTO[:FILE]:YEAR:STATE <State>

Activates the usage of the year in the automatic filename.

Parameters:

<State> 0 | 1 | OFF | ON
 *RST: 1

Example: `HCOPY:FILE:AUTO:YEAR:STAT OFF`
 Deactivates the usage of the year in the automatic filename.

Manual operation: See "File Options" on page 123

:HCOPY:FILE[:NAME]:AUTO:STATe <State>

Activates/deactivates automatic naming of the hardcopy files.

Parameters:

<State> 0 | 1 | OFF | ON
 *RST: 1

Example: HCOPY:FILE:AUTO:STAT OFF
 Deactivates automatic naming.

Manual operation: See "Automatic Naming" on page 123

:HCOPY:IMAGe:FORMat <Format>

This command selects the bitmap graphic format for the screenshot. You can also retrieve the data using command `HCOPY:DATA?`.

This command is an alias to command `HCOPY:DEVIce:LANGuage`.

Parameters:

<Format> BMP | JPG | XPM | PNG
 *RST: PNG

Example: HCOPY:IMAG:FORM XPM
 Selects the image format XPM.

Manual operation: See "File Options" on page 123

:HCOPY:IMAGe:SIZE <Size>

Selects the image size of the hardcopy. The first value of the size setting defines the width, the second value the height of the image.

Parameters:

<Size> string
 *RST: depends on device

Example: HCOPY:IMAG:SIZE 640,480
 Sets width and height of the image.

7.9 KBOard Subsystem

The KBOard system contains the commands to set the external keyboard.

:KBOard:LANGuage	302
:KBOard:LAYout	302

:KBOard:LANGuage <Language>

This command selects the keyboard language. The assignment of some keys depends on the selected language.

Parameters:

<Language> US | DE
*RST: US

Example:

KBO:LANG US
selects keyboard language American English.

Usage:

SCPI confirmed

Manual operation: See "[Layout \(USB Keyboard Settings\)](#)" on page 108

:KBOard:LAYout <Layout>

Selects the keyboard language. The assignment of some keys depends on the selected language.

Parameters:

<Layout> CHINese | DANish | DUTCh | DUTBe | ENGLish | ENGUk |
FINNish | FRENch | FREBe | FRECa | GERMan | ITALian |
JAPanese | KORean | NORWegian | PORTuguese | RUSSian |
SPANish | SWEDish | ENGUS
*RST: ENGLish

Example:

KBO:LAY US
Activates American English keyboard layout.

Manual operation: See "[Layout \(USB Keyboard Settings\)](#)" on page 108

7.10 MMEMory Subsystem

The MMEMory subsystem (**Mass Memory**) contains the commands for managing files and directories as well as for loading and storing complete instrument settings in files.

The files are stored on the internal flash memory of the instrument or on external USB memory devices.

The `/var/user/` directory can be used to save user-defined data; any subdirectory structure can be created on `/var/user/`. Some default subdirectories are predefined, but can be changed at any time.

The default directory is determined using the command `MMEMory:CDIR`.



Use the command `:SYSTem:MMEMory:PATH:USER?` to query the path of the directory for user-defined data.



The `/opt` directory is a protected and therefore a not accessible system directory. The files on this directory contain data that must not be changed. Therefore, this directory should not be accessed, since reconstruction of the system partition will lead to data loss.

7.10.1 File Naming Conventions

To enable files in different file systems to be used, the following file naming conventions should be observed.

The file name can be of any length and is case-sensitive, meaning it is distinguished between uppercase and lowercase letters.

The file and the optional file extension are separated by a dot. All letters and numbers are permitted (numbers are, however, not permitted at the beginning of the file name). If possible, special characters should not be used. The use of the slashes "\" and "/" should be avoided since they are used in file paths. A number of names are reserved for the operating system, e.g. `CLOCK$`, `CON`, `AUX`, `COM1 . . . COM4`, `LPT1 . . . LPT3`, `NUL` and `PRN`.

In the R&S SMB all files in which lists and settings are stored are given a characteristic extension. The extension is separated from the actual file name by a dot (see [Chapter 4.7.2.1, "Extensions for User Files"](#), on page 85 for an overview of the file types).

The two characters "*" and "?" function as "wildcards", meaning they are used for selecting several files. The "?" character represents exactly one character, while the "*" character represents all characters up to the end of the file name. "*.*" therefore stands for all files in a directory.

When used in conjunction with the commands, the parameter `<file_name>` is specified as a string parameter with quotation marks. It can contain either the complete path including the drive, only the path and the file name, or only the file name. The file name must include the file extension. The same applies for the parameters `<directory_name>` and `<path>`.

Depending on how much information is provided, either the values specified in the parameter or the values specified with the command `MMEM:CDIR` (default directory) are used for the path and the drive settings in the commands.

Before the instrument settings can be stored in a file, they have to be stored in an intermediate memory using common command `*SAV <number>`. The specified number is subsequently used in the `:MMEMory:STORe:STATe` on page 311 command. Also, subsequently to loading a file with instrument settings with command `:MMEMory:LOAD:STATe` on page 309, these settings have to be activated with the common command `*RCL <number>`.

7.10.2 Extensions for User Files

The following table lists all available file extensions for user files. The currently available files on the instrument depend on the installed options.

Table 7-1: List of the automatically assigned file extensions in the instrument

Function	List type	Contents	File suffix
Instrument State	Settings	Instrument settings	*.savrltxt
"User Correction"	List	User-defined level correction values	*.uco
		Export Data	*.txt or *.csv
"List Mode"	List	User-defined frequency/level value pairs	*.lsw
		Export Data	*.txt or *.csv
"Pulse Train List"		User-defined offtime/ontime/repetition values	*.pulstrn
SMZ Settings	Settings	Data (firmware) of a connected SMZ frequency multiplier	*.efmfirm
NRP Settings	Settings	NRP Settings	*.nrp

7.10.3 Examples

In these examples, the current instrument setting is stored in the file `test.savrltxt` in the directory `/var/user/..`

Storing and Loading Current Settings

1. Store the current setting in an intermediate memory with the number 4. This setting can be called using command `*RCL` and the associated number of the memory, for example `*RCL 4`.
`*SAV 4`
2. To store the settings in a file in a specific directory, specify the complete path.
`MMEM:STOR:STAT 4, "/var/user/test.savrltxt"`
3. To store the settings in a file in the default drive, set the default drive and specify only the file name.
`MMEM:CDIR '/var/user/'*SAV 4`
`MMEM:STOR:STAT 4, "test.savrltxt"`
4. Load the file `test.savrltxt` in the user directory.
`MMEM:LOAD:STAT 4, '/var/user/test.savrltxt'`
5. Activate the instrument setting of the file `test.savrltxt`.
`*RCL 4`

Working with Files and Directories

1. Read out all files in the specified directory.
`MMEM:CAT? '/usb/user'`

Response: 127145265,175325184,"test,DIR,0","temp,DIR,0",
 "readme.txt,ASC,1324","state.savrcltxt,STAT,5327",
 "waveform.wv,BIN,2342"

the directory `/usb/user` contains the subdirectories `test` and `temp` as well as the files `readme.txt`, `state.savrcltxt` and `waveform.wv` which have different file types.

Tip: To query only the subdirectories of the current or specified directory, perform:
 MMEM:DCAT? '/usb/user'

Response: 'test', 'temp'

To query only the number of subdirectories in the current or specified directory, perform:

MMEM:DCAT:LENG? '/usb/user'

Response: 2

2. To query the number of files in the current or specified directory, perform:

MMEM:CAT:LENG? '/usb/user'

Response: 3

3. Create a new subdirectory for mass memory storage in the specified directory.

MMEM:MDIR '/usb/new'

4. Copy the file `state` to a new file.

MMEM:COPY '/var/user/state.savrcltxt','/usb/new'

5. Rename the file `state`.

MMEM:MOVE 'state.savrcltxt','state_new.savrcltxt'

6. Remove the `test` directory.

MMEM:RDIR '/usb/test'

7.10.4 Remote Control Commands

:MMEMory:CATalog?	306
:MMEMory:CATalog:LENGth?	306
:MMEMory:CDIRectory	306
:MMEMory:COPY	307
:MMEMory:DATA	307
:MMEMory:DCATalog?	308
:MMEMory:DCATalog:LENGth?	308
:MMEMory:DELeTe	309
:MEMory:HFRee?	309
:MMEMory:LOAD:STATe	309
:MMEMory:MDIRectory	310
:MMEMory:MOVE	310
:MMEMory:MSIS	310
:MMEMory:RDIRectory	311
:MMEMory:STORe:STATe	311

:MMEMory:CATalog? <path>

Returns the content of a particular directory.

Query parameters:

<path>	string String parameter to specify the directory. If you leave out the path, the command returns the contents of the directory selected with <code>:MMEMory:CDIRectory</code> . The path may be relative or absolute.
--------	--

Return values:

<UsedDiskSpace>	Byte size of all files in the directory.
<FreeDiskSpace>	Remaining disk space in bytes.
<FileInfo>	<NameFileN>,<SuffixFileN>,<SizeFileN> List of files, separated by commas <NameFileN> Name of the file. <SuffixFileN> Type of the file. Possible suffixes are: ASCii, BINary, DIRectory <SizeFileN> Size of the file in bytes.

Example: See "[Working with Files and Directories](#)" on page 304.

Usage: Query only

Manual operation: See "[Directory, File List and File Name](#)" on page 127

:MMEMory:CATalog:LENGth? <Path>

Returns the number of files in the current or in the specified directory.

Query parameters:

<Path>	string String parameter to specify the directory. If the directory is omitted, the command queries the content of the current directory, queried with <code>:MMEMory:CDIRectory</code> command.
--------	--

Return values:

<FileCount>	integer Number of files.
-------------	-----------------------------

Example: See "[Working with Files and Directories](#)" on page 304.

Usage: Query only

:MMEMory:CDIRectory <Directory>

Changes the default directory for mass memory storage. The directory is used for all subsequent `MMEM` commands if no path is specified with them.

Parameters:

<Directory> <directory_name>
 String containing the path to another directory. The path can be relative or absolute.
 To change to a higher directory, use two dots '..' .

Example: See "[Working with Files and Directories](#)" on page 304.

Usage: SCPI confirmed

Manual operation: See "[Directory, File List and File Name](#)" on page 127

:MMEMory:COPY <SourceFile>[,<DestinationFile>]

Copies an existing file to a new file. Instead of just a file, this command can also be used to copy a complete directory together with all its files.

Setting parameters:

<SourceFile> string
 String containing the path and file name of the source file

<DestinationFile> string
 String containing the path and name of the target file. The path can be relative or absolute.
 If <DestinationFile> is not specified, the <SourceFile> is copied to the current directory, queried with the [:MMEMory:CDIRectory](#) command.

Note: Existing files with the same name in the destination directory are overwritten without an error message.

Example: See "[Working with Files and Directories](#)" on page 304.

Usage: Setting only
 SCPI confirmed

Manual operation: See "[Copy](#) " on page 131

:MMEMory:DATA <Filename>, <BinaryBlock>

:MMEMory:DATA? <Filename>

The setting command writes the block data <BinaryBlock> to the file identified by <Filename>.

Set the GPIB-bus terminator to `EOI` to ensure correct data transfer.

The query command transfers the specified file from the instrument to the GPIB-bus and then on to the controller. It is important to ensure that the intermediate memory on the controller is large enough to take the file. The setting for the GPIB-bus terminator is irrelevant.

Tip: Use this command to read/transfer stored instrument settings or waveforms directly from/to the instrument.

Parameters:

<BinaryBlock> #<number><length_entry><data>
 #: Hash sign; always comes first in the binary block
 <number>: the first digit indicates how many digits the subsequent length entry has
 <length_entry>: indicates the number of subsequent bytes
 <data>: binary block data for the specified length.
 For files with a size with more than nine digits (gigabytes), the instrument allows the syntax # (<Length>), where <Length> is the file size in decimal format.

Parameters for setting and query:

<Filename> string
 String parameter to specify the name of the file.

Example:

```
MMEMory:DATA '/var/user/test.txt',#15hallo
Writes the block data to the file test.txt.
The digit 1 indicates a length entry of one digit; the digit 5 indicate a length of the binary data (hallo) in bytes.
MMEMory:DATA? '/var/user/test.txt'
Sends the data of the file test.txt from the instrument to the controller in the form of a binary block.
Response: #15hallo
```

Usage: SCPI confirmed

:MMEMory:DCATalog? <path>

Returns the subdirectories of a particular directory.

Query parameters:

<path> String parameter to specify the directory. If the directory is omitted, the command queries the content of the current directory, queried with `:MMEMory:CDIRectory` command.

Return values:

<Catalog> <file_entry>
 Names of the subdirectories separated by colons. The first two strings are related to the parent directory.

Example: See "[Working with Files and Directories](#)" on page 304.

Usage: Query only

:MMEMory:DCATalog:LENGth? [<Path>]

Returns the number of subdirectories in the current or specified directory.

Query parameters:

<Path> String parameter to specify the directory. If the directory is omitted, the command queries the contents of the current directory, to be queried with `:MMEMory:CDIRectory` command.

Return values:

<DirectoryCount> integer
Number of parent and subdirectories.

Example: See ["Working with Files and Directories"](#) on page 304.

Usage: Query only

:MMEMory:DELeTe <Filename>

Removes a file from the specified directory.

Setting parameters:

<Filename> string
String parameter to specify the name and directory of the file to be removed.

Example: See ["Working with Files and Directories"](#) on page 304.

Usage: Event
SCPI confirmed

Manual operation: See ["Cut"](#) on page 131

:MEMory:HFRee?

Returns the used and available memory in Kb.

Return values:

<TotalPhysMemKb> integer
Total physical memory.

<ApplicMemKb> integer
Application memory.

<HeapUsedKb> integer
Used heap memory.

<HeapAvailableKb> integer
Available heap memory.

Usage: Query only

:MMEMory:LOAD:STATe <SavRclStateNumb>, <file_name>

Loads the specified file stored under the specified name in an internal memory.

After the file has been loaded, the instrument setting must be activated using an *RCL command.

Setting parameters:

<SavRclStateNumb> Determines to the specific <number> to be used with the *RCL command, e.g. *RCL 4.

<file_name> String parameter to specify the file name with extension
*.savrc1.txt.

Example: See ["Storing and Loading Current Settings"](#) on page 304.

Usage: Setting only

Manual operation: See ["Recall"](#) on page 129

:MMEMory:MDIRectory <Directory>

Creates a subdirectory for mass memory storage in the specified directory. If no directory is specified, a subdirectory is created in the default directory. This command can also be used to create a directory tree.

Setting parameters:

<Directory> string
String parameter to specify the new directory.

Example: See ["Working with Files and Directories"](#) on page 304.

Usage: Event

Manual operation: See ["Create New Directory"](#) on page 132

:MMEMory:MOVE <SourceFile>, <DestinationFile>

Moves an existing file to a new location or, if no path is specified, renames an existing file.

Setting parameters:

<SourceFile> string
String parameter to specify the name of the file to be moved.

<DestinationFile> string
String parameters to specify the name of the new file.

Example: See ["Working with Files and Directories"](#) on page 304.

Usage: Event
SCPI confirmed

Manual operation: See ["Rename "](#) on page 132

:MMEMory:MSIS <Msis>

Defines the drive or network resource (in the case of networks) for instruments with windows operating system, using `msis` (MSIS = Mass Storage Identification String).

Note: Instruments with Linux operating system ignore this command, since Linux does not use drive letter assignment.

Usage: SCPI confirmed

:MMEMory:RDIRectory <Directory>

Removes an existing directory from the mass memory storage system. If no directory is specified, the subdirectory with the specified name is deleted in the default directory.

Setting parameters:

<Directory> string
String parameter to specify the directory to be deleted.

Example: See ["Working with Files and Directories"](#) on page 304.

Usage: Event

:MMEMory:STORE:STATe <savrcl_state_nr>, <file_name>

Stores the current instrument setting in the specified file.

The instrument setting must first be stored in an internal memory with the same number using the common command *SAV.

Setting parameters:

<savrcl_state_nr> Corresponds to the specific <number> defined with the *SAV command, e.g. *SAV 4.

<file_name> String parameter to specify the file name with extension *.savrcltxt.

Example: See ["Storing and Loading Current Settings"](#) on page 304.

Usage: Event

Manual operation: See ["Save"](#) on page 128

7.11 OUTPut Subsystem

The OUTPut system contains the commands which set the properties of the RF output connector.

The properties of the LF output connector are set in the [SOURCE:LFOutput Subsystem](#) system.

:OUTPut<hw>:AFIXed:RANGe:LOWer?	312
:OUTPut<hw>:AFIXed:RANGe:UPPer?	312
:OUTPut<hw>:ALC:SEARch:MODE	312
:OUTPut<hw>:AMODE	313
:OUTPut<hw>:FILTer:AUTO	313
:OUTPut<hw>:FILTer[:LPASs]:STATe	313
:OUTPut<hw>:IMPedance?	314
:OUTPut<hw>:PROTection:CLEar	314
:OUTPut<hw>:PROTection:TRIPped?	314
:OUTPut<hw>[:STATe]	314
:OUTPut<hw>[:STATe]:PON	315

:OUTPut<hw>:AFIXed:RANGe:LOWer?

Queries the minimum level which can be set when the attenuator is fixed, see :
[OUTPut<hw>:AMODE](#).

Return values:

<Lower> float
 Increment: 0.01

Example: `OUTP:AFIX:RANG:LOW?`
 queries the minimum level for the FIXed setting.

Example: Response: -50
 The minimum level is -50 dBm.

Usage: Query only

Manual operation: See "[Fixed Range \(PEP\) In](#)" on page 149

:OUTPut<hw>:AFIXed:RANGe:UPPer?

Queries the maximum level which can be set when the attenuator is fixed, see :
[OUTPut<hw>:AMODE](#).

Return values:

<Upper> float
 Increment: 0.01

Example: `OUTP:AFIX:RANG:UPP?`
 queries the maximum level for the FIXed setting for the RF output.

Example: Response: -27
 The maximum level is -27 dBm.

Usage: Query only

Manual operation: See "[Fixed Range \(PEP\) In](#)" on page 149

:OUTPut<hw>:ALC:SEARch:MODE <Mode>

Activates/deactivates the RF output during the power search.

Parameters:

<Mode> NORMal | MINimum
 *RST: NORMal

Example: `POW:ALC:SEAR:MODE NORM`
 during the power search, the RF output is active.

Manual operation: See "[RF During Power Search - ALC](#)" on page 153

:OUTPut<hw>:AMODe <AMode>

Selects the mode of the attenuator at the RF output (Attenuator MODE).

Parameters:

<AMode> AUTO | FIXed

AUTO

The attenuator is switched automatically. The level settings are made in the full range.

FIXed

The level settings are made without switching the attenuator. When this operating mode is switched on, the attenuator is fixed in its current position and the resulting variation range is defined.

*RST: AUTO

Example:

```
POW:ALC ON
activates automatic level control for RF output.
OUTP:AMOD FIX
sets the fixed mode with uninterrupted level for RF output.
```

Manual operation: See "[Attenuator Mode](#)" on page 149

:OUTPut<hw>:FILTer:AUTO <Auto>

Activates automatic switching of the low harmonic filter.

Parameters:

<Auto> 0 | 1 | ON | OFF

*RST: 0

Example:

```
OUTP:FILT:AUTO 1
Activates the auto mode.
```

Manual operation: See "[Mode](#)" on page 149

:OUTPut<hw>:FILTer[:LPASs]:STATe <State>

Switches the filter state in manual mode and disables the automatic mode, if activated.

Parameters:

<State> 0 | 1 | OFF | ON

*RST: 0

Example:

```
OUTP:FILT:AUTO 0
OUTP:FILT:LPAS:STAT 1
Selects manual mode and activates the low harmonic filter.
OUTP:FILT:STAT?
Queries the current filter activity.
```

Manual operation: See "[State](#)" on page 149

:OUTPut<hw>:IMPedance?

Queries the impedance of the RF outputs. It enables you to convert the output level units between V and W. The impedances cannot be changed.

Return values:

<Impedance> G1K | G50 | G10K
 *RST: G50
 Default unit: Ohm

Example:

OUTP:IMP
 queries the impedance of RF output.
 Response: 50
 the impedance is 50 ohms

Usage: Query only

:OUTPut<hw>:PROTection:CLEar

Resets the protective circuit after it has been tripped. The state of the output is again determined by OUTPut:STATe.

Example:

OUTP:PROT:CLE
 resets the protective circuit for RF output.

Usage: Event

Manual operation: See "[Overload](#)" on page 166

:OUTPut<hw>:PROTection:TRIPped?

Queries the state of the protective circuit.

Return values:

<Tripped> 0 | 1 | OFF | ON
 *RST: 0

Example:

OUTP:PROT:TRIP
 Queries the state of the protective circuit for RF output A.
 Response: 0
 The protective circuit has not tripped.
 Response: 1
 The protective circuit has tripped.

Usage: Query only

Manual operation: See "[Overload](#)" on page 166

:OUTPut<hw>[:STATe] <State>

Activates and deactivates the RF output signal (RF ON / RF OFF).

Parameters:

<State> 0 | 1 | OFF | ON
 *RST: 0

Example:

OUTP OFF
 deactivates the RF output.

Manual operation: See "RF On" on page 135

:OUTPUT<hw>[:STATE]:PON <Pon>

Selects the state of the RF output when the instrument is switched on.

Parameters:

<Pon> OFF | UNCHanged

OFF

deactivates the output when the instrument is switched on (RF OFF).

UNCHanged

restores the initial state of the RF output before the last turn off.
 sets the output status as it was when the instrument was switched off.

*RST: UNCHanged

Example:

OUTP:PON OFF
 RF output A is deactivated when the instrument is switched on.

Manual operation: See "Power-On State - RF Signal" on page 151

7.12 SENSe, READ and INITiate Subsystems

The SENSe subsystem contains the commands for configuring the power measurements with R&S NRP-Zxx power sensor(s) connected to the generator. The measurement is started and the measurement result retrieved with the READ command. The description of this commands is included in the following.

Up to four sensors can be connected to the signal generator. They are distinguished by means of the suffix under SENSe, that means SENSe [1] ... SENSe 4.

:SENSe<ch>[:POWer]:APERTure:DEFault:STATe.....	316
:SENSe<ch>[:POWer]:APERTure:TIME.....	316
:INITiate<ch>[:POWer]:CONTInuous.....	316
:READ<ch>[:POWer]?.....	317
:SENSe<ch>[:POWer]:CORRection:SPDevice:STATe.....	317
:SENSe<ch>[:POWer]:DISPlay:PERManent:STATe.....	318
:SENSe<ch>[:POWer]:DISPlay:PERManent:PRiority.....	318
:SENSe<ch>[:POWer]:FILTer:LENGth:AUTO?.....	318
:SENSe<ch>[:POWer]:FILTer:LENGth[:USER].....	319
:SENSe<ch>[:POWer]:FILTer:NSRatio.....	319
:SENSe<ch>[:POWer]:FILTer:NSRatio:MTIME.....	320

:SENSe<ch>[:POWer]:FILTer:SONCe.....	320
:SENSe<ch>[:POWer]:FILTer:TYPE.....	320
:SENSe<ch>[:POWer]:LOGGing:STATe.....	321
:SENSe<ch>[:POWer]:FREQuency.....	321
:SENSe<ch>[:POWer]:OFFSet.....	322
:SENSe<ch>[:POWer]:OFFSet:STATe.....	322
SENSe<ch>[:POWer]:SNUMber?.....	322
:SENSe<ch>[:POWer]:SOURce.....	323
SENSe<ch>[:POWer]:STATus[:DEVice]?.....	323
SENSe<ch>[:POWer]:SVERsion?.....	323
SENSe<ch>[:POWer]:TYPE?.....	324
:SENSe<ch>[:POWer]:ZERO.....	324
:SENSe<ch>:UNIT[:POWer].....	324

:SENSe<ch>[:POWer]:APERture:DEFault:STATe <UseDefAp>

Deactivates the default aperture time of the respective sensor.

To specify a user-defined value, use the command `:SENSe<ch>[:POWer]:APERture:TIME` on page 316.

Parameters:

<UseDefAp> 0 | 1 | OFF | ON
*RST: 1

Example:

`SENS:POW:APER:DEF:STAT 0`
deactivates the default aperture time of the sensor.

Manual operation: See "Use Default Aperture Time" on page 173

:SENSe<ch>[:POWer]:APERture:TIME <ApTime>

Defines the aperture time (size of the acquisition interval) for the corresponding sensor.

Parameters:

<ApTime> float
Range: depends on connected power sensor
Increment: 1E-9
*RST: depends on connected power sensor

Example:

`SENS:POW:APER:TIM 23ms`
sets 23 ms aperture time.

Manual operation: See "Aperture Time" on page 173

:INITiate<ch>[:POWer]:CONTInuous <Continuous>

The command switches the local state of the continuous power measurement by the R&S NRP-Zxx power sensors on and off. Switching the local state off enhances the measurement performance during remote control

The remote measurement is triggered by the READ query (command `:READ<ch>[:POWER]?` on page 317) which also provides the measurement results. The local state is not influenced by this command, measurements results can be retrieved with local state on or off.

Parameters:

<Continuous> 0 | 1 | OFF | ON
 *RST: OFF

Example:

INIT:CONT ON
 switches local state of continuous power measurement on.

Manual operation: See "State" on page 169

:READ<ch>[:POWER]?

The command triggers the measurement with power sensors and provides the power measurement result of the selected power sensor. The value is provided with the unit set with command `SENSe:UNIT[:POWER]`.

For certain power sensors, e.g. R&S NRP-Z81, two values are returned, first the value for the average level and - separated by a comma - the peak level

Note: The local state is not influenced by this command, measurements results can be retrieved with local state on or off. For long measurement times it is recommended to use a SRQ (MAV bit) for command synchronization.

Suffix:

<ch> 1..3

Return values:

<Power> string

Example:

SENSe:UNIT DBM
 selects unit dBm for presentation of measurement result.
 READ1?
 queries the measurement result of the sensor connected to the SENSOR interface.
 Response: -45.6246576745440230
 -45.6 dBm were measured at the given frequency.
 or e.g. for R&S NRP-Z81
 Response:
 -55.62403263352178,-22.419472478812476
 -55.6 dbm is the measured average level, -22.4 dBm is the measured peak level at the given frequency

Usage: Query only

Manual operation: See "Level (Peak)" on page 169

:SENSe<ch>[:POWER]:CORRection:SPDevice:STATe <State>

The command activates the use of the s-parameters correction data of the selected power sensor.

Note: For power sensor with attenuator this command is automatically set to ON.

Parameters:

<State> 0 | 1 | OFF | ON
*RST: OFF

Example:

SENS:POW:CORR:SPD:STAT ON
activates the use of the s-parameters correction data of power sensor 1.

Manual operation: See ["Use SParameter - Power Sensors"](#) on page 157

:SENSe<ch>[:POWer]:DISPlay:PERMANent:STATe <State>

The command switches on and off the permanent indication of the power measurement result in the upper right corner of the block diagram. For each sensor, the type of sensor, the connector, the measurement source and - if set - the offset is indicated.

Parameters:

<State> 0 | 1 | OFF | ON
*RST: ON

Example:

SENS1:POW:DISP:PERM:STAT ON
the permanent viewer is switched on.

Manual operation: See ["Permanent Display State"](#) on page 170

:SENSe<ch>[:POWer]:DISPlay:PERMANent:PRiority <Priority>

The command selects which power measurement result (average or peak power) is indicated when permanent display is active.

Parameters:

<Priority> AVERAge | PEAK
*RST: PEAK

Example:

SENS1:DISP:PERM:STAT ON
the permanent viewer is switched on.
SENS1:DISP:PERM:PRI AVER
the measured average power is indicated.

Manual operation: See ["Display Priority"](#) on page 170

:SENSe<ch>[:POWer]:FILTer:LENGth:AUTO?

The command queries the current filter length for auto filter mode
(:SENSe<[1]...3>:POWer:FILTer:TYPE AUTO)

Return values:

<Auto> float
Range: 1 to 65536

Example: SENS1:FILT:TYPE AUTO
selects auto filter mode for the power sensor connected to the
SENSOR connector.
SENS1:FILT:LENG:AUTO?
queries the automatically set filter length.
Response: 1024

Usage: Query only

Manual operation: See "Filter Length" on page 172

:SENSe<ch>[:POWER]:FILTer:LENGth[:USER] <User>

The command selects the filter length for user filter mode (SENSe:POWer:FILTer:TYPE USER). As the filter length works as a multiplier for the time window, a constant filter length results in a constant measurement time. Values 1 and 2ⁿ are settable.

The time window is fixed to 20 ms.

Parameters:

<User> float
Range: 1 to 65536
*RST: 1

Example: SENS:FILT:TYPE USER
selects user filter mode.
SENS:FILT:LENG 16
sets a filter length of 16. The resulting measurement time is 640
ms (2x16x20 ms).

Manual operation: See "Filter Length" on page 172

:SENSe<ch>[:POWER]:FILTer:NSRatio <NSRatio>

The command defines the noise content for fixed noise filter mode (:SENSe<[1]...3>:POWer:FILTer:TYPE NSRatio). This value determines the proportion of intrinsic noise in the measured result.

Parameters:

<NSRatio> float
Range: 0.001 to 1
Increment: 0.001
*RST: 0.01

Example: SENS1:FILT:TYPE NSR
selects fixed noise filter mode for the power sensor connected to
the SENSOR connector.
SENS1:FILT:NSR 0.2
sets a noise content of 0.2.

Manual operation: See "Noise Content" on page 172

:SENSe<ch>[:POWer]:FILTer:NSRatio:MTIME <MTime>

The command defines the timeout for fixed noise filter mode (:SENSe<[1]...3>:POWer:FILTer:TYPE NSRatio). This value ensures limited settling times.

Parameters:

<MTime> float
 Range: 1 to 999.99
 Increment: 0.01
 *RST: 4
 Default unit: s

Example:

```
SENS1:FILT:TYPE NSR
selects fixed noise filter mode for the power sensor connected to
the SENSOR connector.
SENS1:FILT:NSR .2
sets a noise content of 0.2.
SENS1:FILT:NSR:MTIM 5
limits the settling time to 5 seconds
```

Manual operation: See "[Timeout](#)" on page 172

:SENSe<ch>[:POWer]:FILTer:SONCe

The command activates the search for the optimum filter length for the current measurement conditions. The found filter length can be retrieved with command :SENSe:POWer:FILTer:LENGth:USER?. This command is only available for user filter mode (:SENSe:POWer:FILTer:TYPE USER).

Example:

```
SENS:FILT:TYPE USER
selects user filter mode.
SENS:FILT:SONC
activates the search for the optimum filter length.
SENS:FILT:LENG?
returns the found optimum filter length.
Response: 128
```

Usage: Event

Manual operation: See "[Auto Once](#)" on page 173

:SENSe<ch>[:POWer]:FILTer:TYPE <Type>

The command selects the filter mode. The filter length is the multiplier for the time window and thus directly influences the measurement time.

Parameters:

<Type>

AUTO | USER | NSRatio

AUTO

The filter length is automatically selected depending on the measured value. For high values, a short filter length is selected and for low values a long filter length is selected.

USER

The filter length is set manually. As the filter length works as a multiplier for the measurement time, this results in a constant measurement time.

NSRatio

The filter length (averaging factor) is selected so that the sensor's intrinsic noise (2 standard deviations) does not exceed the specified noise content. The desired noise content is entered with command `SENSe:FILTer:NSRatio`.

To avoid very long settling times when the power is low, the averaging factor can be limited with the Timeout parameter (command `SENSe:FILTer:NSRatio:MTIME`).

*RST: AUTO

Example:`SENS:FILT:TYPE AUTO`

selects automatic filter selection.

Manual operation: See "[Filter](#)" on page 171**:SENSe<ch>[:POWer]:LOGGing:STATe <State>**

Activates the recording of the power values, measured by a connected R&S NRP-Z power sensor.

Parameters:

<State>

0 | 1 | OFF | ON

*RST: 0

Example:`SENS:LOGG:STAT ON`

activates recording of the power measurement of the first sensor.

Manual operation: See "[Enable Logging](#)" on page 173**:SENSe<ch>[:POWer]:FREQuency <Frequency>**

The command sets the RF frequency of the source if the user source is selected (`SENSe[:POWer]:SOURce USER`).

Parameters:

<Frequency>

float

*RST: 1 GHz

Example: SENS:SOUR USER
 selects user-defined source.
 SENS:FREQ 2.44 GHz
 enters the RF frequency of the source which is 2.44 GHz.

Manual operation: See "[Frequency](#)" on page 171

:SENSe<ch>[:POWer]:OFFSet <Offset>

The command enters a level offset which is added to the measured level value after activation with command `SENSe[:POWer]:OFFSet:STATe ON`. This allows e.g. an attenuator in the signal path to be considered.

Parameters:

<Offset> float
 Range: -100.0 to 100.0
 *RST: 0
 Default unit: dB

Example: SENS:POW:OFFS 10.0
 sets a level offset of 10 dB

Manual operation: See "[Level Offset](#)" on page 171

:SENSe<ch>[:POWer]:OFFSet:STATe <State>

The command activates the addition of the level offset to the measured value. The level offset value is set with command `SENSe[:POWer]:OFFSet`.

Parameters:

<State> 0 | 1 | OFF | ON
 *RST: OFF

Example: SENS1:POW:OFFS 0.4dB
 sets a level offset of 0.4 dB
 SENS1:POW:OFFS:STAT ON
 a level offset of 0.4 dB is added to the measured value.

Manual operation: See "[Level Offset](#)" on page 171

SENSe<ch>[:POWer]:SNUMber?

The command queries the serial number of the sensor.

Return values:

<Snumber> string

Example: SENS:SNUM?
 queries the serial number.

Usage: Query only

Manual operation: See "[Current Sensors](#)" on page 98

:SENSe<ch>[:POWER]:SOURce <Source>

The command selects the signal source for the measurement.

Parameters:

<Source> A | B | USER | RF
*RST: A

Example:

SENS:SOUR A
selects the RF signal as measurement source. The RF frequency is used as the measurement frequency of the sensor and the corresponding correction factor is used. The level setting of the instrument serves as reference level of the measurement.

Manual operation: See "[Source](#)" on page 171

SENSe<ch>[:POWER]:STATus[:DEVIce]?

The command queries if a sensor is connected to the signal generator.

The sensor is selected by suffix in the keyword SENSE or READ of the command header. Suffix 1 denotes the sensor connected to the SENSOR connector, suffix 2 the sensor connected first to one of the USB interfaces and suffix 3 the sensor connected second to one of the USB interfaces.

Return values:

<DEVIce> 0 | 1 | OFF | ON

Example:

SENS:STAT?
queries if a sensor is connected to the instrument.
Response: 1
a sensor is connected to the POWER SENSOR interface.

Usage: Query only

Manual operation: See "[Sensor](#)" on page 168

SENSe<ch>[:POWER]:SVERsion?

The command queries the software version of the connected R&S NRP power sensor.

Return values:

<Sversion> string

Example:

SENS:POW:SVER?
queries the software version of the R&S NRP power sensor.

Usage: Query only

Manual operation: See "[Current Sensors](#)" on page 98

SENSe<ch>[:POWER]:TYPE?

The command queries the type of sensor. The type is automatically detected.

Return values:

<Type> string

Example:

SENS:TYPE?

queries the type of sensor connected to the POWER SENSOR connector.

Response: NRP-Z21

the R&S NRP-Z21 sensor is used.

Usage:

Query only

Manual operation: See "[Current Sensors](#)" on page 98

:SENSe<ch>[:POWER]:ZERO

The command activates the autozero function. Zeroing is required in regular interval (at least once a day) and if the temperature has varied more than about 5 °C, if the sensor has been replaced or if measurements of signals with very low power are to be performed. The RF power source must be switched off or disconnected from the sensor before starting the autozero function.

Example:

SENS:ZERO

activates autozero function.

Usage:

Event

Manual operation: See "[Zero - Power Sensors](#)" on page 156

:SENSe<ch>:UNIT[:POWER] <Power>

The command selects the unit used for result query with command READ. The power sensor provides the measured value in Watt. In which unit the measured value is returned is selected here and might be either Watt, dBm or dBuV.

Parameters:

<Power> DBM | DBUV | WATT

*RST: DBM

Example:

SENS2:UNIT DBM

selects unit dBm for the measured value returned by command READ.

READ2?

Response: 7.34

7.34 dBm are measured by sensor 2.

Manual operation: See "[Unit](#)" on page 169

7.13 SOURce Subsystem

The SOURce subsystem contains the commands for configuring the digital and analog signals.

SOURce<hw>

For one-path instruments, the keyword SOURce is optional and can be omitted.

• SOURce:AM Subsystem.....	325
• SOURce:CORRection Subsystem.....	328
• SOURce:FM Subsystem.....	337
• SOURce:FREQUency Subsystem.....	340
• SOURce:INPut Subsystem.....	347
• SOURce:LFOutput Subsystem.....	348
• SOURce:LIST Subsystem.....	358
• SOURce:MODulation Subsystem.....	371
• SOURce:PGEN Subsystem.....	371
• SOURce:PHASe Subsystem.....	372
• SOURce:PM Subsystem.....	373
• SOURce:POWEr Subsystem.....	376
• SOURce:PULM Subsystem.....	387
• SOURce:ROSCillator Subsystem.....	405
• SOURce:STEReo Subsystem.....	408
• SOURce:SWEEp Subsystem.....	417

7.13.1 SOURce:AM Subsystem

The AM subsystem contains the commands for setting the amplitude modulation.

An external modulation signal is input at the MOD EXT connector.

The settings for the internal modulation source (LF generator) are made in the SOURce:LFOutput subsystem.

[SOURce<hw>]:AM:DEPTTh:EXPonential.....	325
[SOURce<hw>]:AM:DEPTTh:LINear.....	326
[SOURce<hw>]:AM:EXTernal:COUPling.....	326
[SOURce<hw>]:AM:SENSitivity?.....	327
[SOURce<hw>]:AM:SOURce.....	327
[SOURce<hw>]:AM:STATE.....	328
[SOURce<hw>]:AM:TYPE.....	328

[SOURce<hw>]:AM:DEPTTh:EXPonential <DepthExp>

Sets the overall modulation depth of the amplitude modulation in dB.

Note: The exponential AM mode applies to instruments with frequency option 12 GHz or higher. You can select this mode with command [:SOURce<hw>] :AM:TYPE. For more details, see also the GUI reference, [Chapter 5.4.2, "Amplitude Modulation \(AM\)"](#), on page 198.

Parameters:

<DepthExp> float
 Range: -40 to 40
 Increment: 0.01
 *RST: 10

Example:

AM:DEPT:LIN 15PCT
 sets the AM modulation depth to 15 percent.

Options:

(exponential): R&S SMB-B112/-B112L/-B120/-B120L/-B140/-B140L

Manual operation: See ["AM Depth"](#) on page 200

[:SOURce<hw>]:AM:DEPT:h:LINear <DepthLin>

Sets the overall modulation depth of the amplitude modulation in percent.

Note: For high frequency instruments, you can alternatively select exponential amplitude modulation with command `[:SOURce<hw>] :AM:TYPE`. In this case, the generator sets modulation depth in dB (logarithmic).

For more details, see also the GUI reference, [Chapter 5.4.2, "Amplitude Modulation \(AM\)"](#), on page 198.

Parameters:

<DepthLin> float
 Range: 0 to 100
 Increment: 0.1
 *RST: 30

Example:

AM:DEPT:LIN 15
 sets the AM modulation depth to 15 dB.

Manual operation: See ["AM Depth"](#) on page 200

[:SOURce<hw>]:AM:EXTernal:COUPling <Coupling>

Selects the coupling mode for the external amplitude modulation signal.

Parameters:

<Coupling> AC | DC
AC
 Uses only the AC signal component of the modulation signal.
DC
 Uses the modulation signal as it is, with AC and DC.
 *RST: AC

Example:

AM:EXT:COUP AC
 selects the coupling mode AC for external amplitude modulation.

Manual operation: See ["AM External Coupling"](#) on page 201

[:SOURce<hw>]:AM:SENSitivity?

Queries the input sensitivity of the externally applied signal for amplitude modulation.

The sensitivity depends on the set modulation depth, see [:SOURce<hw>]:AM:DEPT h:LINear and [:SOURce<hw>]:AM:DEPT h:EXponential.

The returned value reports the sensitivity in %/V. It is assigned to the voltage value for full modulation of the input.

Return values:

<Sensitivity> float
Range: 0 to 100

Example:

```
AM:DEPT 50
sets a modulation depth of 50 %.
AM:SENS?
queries the input sensitivity at the external modulation input.
Response: 50
since the voltage value for full modulation is 1V, the resulting
sensitivity is precisely 50 %/V.
```

Usage: Query only

Manual operation: See "AM Sensitivity" on page 201

[:SOURce<hw>]:AM:SOURce <Source>

Selects the modulation signal source for amplitude modulation.

With linear AM (see [:SOURce<hw>]:AM:TYPE on page 328), you can use both, the internal and an external modulation signal at a time, for example to perform two-tone AM.

Parameters:

<Source> INTernal | EXTernal | INT,EXT

INTernal

Uses the internally generated signal for modulation. To configure the frequency, use the commands of the [Chapter 7.13.6, "SOURce:LFOutput Subsystem"](#), on page 348 subsystem.

EXTernal

Uses an externally applied modulation signal.

INT,EXT

Uses both, the internal and external modulation signals.

```
*RST: INT
```

Example:

```
AM:SOUR INT
selects the internal modulation source.
```

Manual operation: See "AM Source" on page 199

[:SOURce<hw>]:AM:STATe <State>

Activates amplitude modulation.

Parameters:

<State> 0 | 1 | OFF | ON
 *RST: 0

Example: AM:STAT ON
 activates AM modulation.

Manual operation: See "State" on page 199

[:SOURce<hw>]:AM:TYPE <AmType>

Selects exponential or linear amplitude modulation.

Exponential amplitude modulation is available for instruments, equipped with 12 GHz or higher frequency options. For more details, see also the GUI reference [Chapter 5.4.2, "Amplitude Modulation \(AM\)"](#), on page 198.

Parameters:

<AmType> LINear | EXPonential
 *RST: LINear

Example: AM:TYPE EXP
 activates the exponential amplitude modulation.

Options: (exponential): R&S SMB-B112/-B112L/-B120/-B120L/-B140/-
 B140L

Manual operation: See "AM Type" on page 200

7.13.2 SOURce:CORRection Subsystem

The output level is corrected in the CORRection subsystem. Correction is performed by user-defined table values being added to the output level for the respective RF frequency. In the R&S SMB, this subsystem is used to select, transfer and activate user correction tables.

Each list is stored as a file. The name of the user correction file can be freely selected. The file extension *.uco is assigned automatically and cannot be changed.

The files can be stored in a freely selectable directory and opened from there. The default directory is set using command :MMEMory:CDIRectory on page 306. In the case of files which are stored in the default directory, only the file name has to be specified in commands. Otherwise, the complete absolute path has to be specified with every command. The extension can be omitted in any case.



In the following command examples, the files are stored in the default directory.

The amplitude can also be linearized automatically by means of a R&S NRP power sensor connected to the generator output signal. With the aid of the command `[[:SOURce<hw>]:CORRection:CSET:DATA[:SENSor<ch>][:POWer]:SONCe]`, a list with correction values for external test assemblies can be automatically determined, e.g. for compensating the frequency response of cables. The correction values can be acquired any time irrespective of the modulation settings of the generator.

<code>[[:SOURce]:CORRection:CSET:CATalog?</code>	329
<code>[[:SOURce<hw>]:CORRection:CSET:DATA:FREQuency</code>	330
<code>[[:SOURce<hw>]:CORRection:CSET:DATA:FREQuency:POINts?</code>	330
<code>[[:SOURce<hw>]:CORRection:CSET:DATA:POWer</code>	330
<code>[[:SOURce<hw>]:CORRection:CSET:DATA:POWer:POINts?</code>	331
<code>[[:SOURce<hw>]:CORRection:CSET:DATA[:SENSor<ch>][:POWer]:SONCe</code>	331
<code>[[:SOURce]:CORRection:CSET:DELete</code>	331
<code>[[:SOURce<hw>]:CORRection:DEXChange:AFILe:CATalog?</code>	332
<code>[[:SOURce<hw>]:CORRection:DEXChange:AFILe:EXTension</code>	332
<code>[[:SOURce<hw>]:CORRection:DEXChange:AFILe:SELect</code>	332
<code>[[:SOURce<hw>]:CORRection:DEXChange:AFILe:SEParator:COLumn</code>	333
<code>[[:SOURce<hw>]:CORRection:DEXChange:AFILe:SEParator:DECimal</code>	333
<code>[[:SOURce<hw>]:CORRection:DEXChange:EXECute</code>	334
<code>[[:SOURce<hw>]:CORRection:DEXChange:MODE</code>	334
<code>[[:SOURce<hw>]:CORRection:DEXChange:SELect</code>	335
<code>[[:SOURce<hw>]:CORRection:CSET[:SELect]</code>	335
<code>[[:SOURce<hw>]:CORRection[:STATe]</code>	336
<code>[[:SOURce<hw>]:CORRection:VALue?</code>	336
<code>[[:SOURce<hw>]:CORRection:ZERoing:STATe</code>	336

`[[:SOURce]:CORRection:CSET:CATalog?`

Requests a list of user correction tables. The individual lists are separated by commas.

The lists are stored with the fixed file extensions `*.uco` in a directory of the user's choice. The directory applicable to the commands is defined with the command `MMEMoRY:CDIR`.

Return values:

<Catalog> string

Example:

```
MMEM:CDIR '/var/user/ucor'
```

selects the directory for the user correction files.

```
CORR:CSET:CAT?
```

queries which correction tables are available.

```
Response:UCOR1,UCOR2,UCOR3
```

the correction tables `UCOR1`, `UCOR2` and `UCOR3` are available.

Usage:

Query only

Manual operation: See "[Directory, File List and File Name](#)" on page 127

[[:SOURce<hw>]:CORRection:CSET:DATA:FREQuency <Frequency>

Transfers the frequency data to the table selected with `:CORRection:CSET:SElect`.

The numerical suffix at SOURce must not be used for this command.

Parameters:

<Frequency> Frequency#1[, Frequency#2, ...]
 Range: 300 kHz to RFmax (depending on model)

Example:

```
CORR:CSET '/var/user/ucor1'
selects the table ucor1.
CORR:CSET:DATA:FREQ 100MHz,102MHz,103MHz,...
enters the frequency value in the table ucor1.
```

Manual operation: See ["Edit User Cor. Data - User Correction"](#) on page 159

[[:SOURce<hw>]:CORRection:CSET:DATA:FREQuency:POINts?

The command queries the number of frequency values in the selected table.

The numerical suffix at SOURce must not be used for this command.

Return values:

<Points> integer
 Range: 0 to 10000
 *RST: 0

Example:

```
CORR:CSET '/var/user/'
selects the table ucor1.
CORR:CSET:DATA:FREQ:POIN?
queries the number of frequency values in the table ucor1.
Response: 440
the table ucor1 contains 440 frequency values.
```

Usage: Query only

[[:SOURce<hw>]:CORRection:CSET:DATA:POWEr <Power>

Transfers the level data to the table selected with `[[:SOURce<hw>]:CORRection:CSET[:SElect]`.

*RST does not affect data lists. The numerical suffix at SOURce must not be used for this command.

Parameters:

<Power> Power#1[, Power#2, ...]

Example:

```
CORR:CSET '/var/user/ucor1'
selects the table ucor1.
CORR:CSET:DATA:POW 1dB, 0.8dB, 0.75dB,...
enters the level values in the table ucor1.
```

Manual operation: See ["Edit User Cor. Data - User Correction"](#) on page 159

[[:SOURce<hw>]:CORRection:CSET:DATA:POWer:POINts?

Queries the number of level values in the selected table.

The numerical suffix at `SOURce` must not be used for this command.

Return values:

<Points> integer
 Range: 0 to 10000
 *RST: 0

Example:

```
CORR:CSET '/var/user/ucor1'
selects the table ucor1.
CORR:CSET:DATA:POW:POIN?
queries the number of level values in the table ucor1.
Response: 440
the table ucor1 contains 440 level values.
```

Usage: Query only

[[:SOURce<hw>]:CORRection:CSET:DATA[:SENSor<ch>]:[POWer]:SONC

The command fills the selected user correction list with the level values measured by the power sensor for the given frequencies.

To select the used power sensor set the suffix in key word `SENSe`.

Example:

```
CORR:CSET:DATA:SENS:POW:SONC
fills the user correction list with level values acquired by the
power sensor connector to the SENSOR connector.
```

Usage: Event

Manual operation: See ["Fill User Correction Data with Sensor"](#) on page 165

[[:SOURce]:CORRection:CSET:DELeTe <Filename>

Deletes the specified table.

The lists are stored with the fixed file extensions `*.uco` in a directory of the user's choice. The directory applicable to the commands is defined with the command `MMEMory:CDIR`. A path can also be specified in command `SOUR:CORR:CSET:CAT?`, in which case the file in the specified directory is deleted.

Setting parameters:

<Filename> <table name>

Example:

```
MMEM:CDIR '/var/user/ucor'
selects the directory for the user correction files.
CORR:CSET:DEL 'UCOR1'
deletes the table ucor1.
```

Usage: Setting only

Manual operation: See ["User Cor. Data - User Correction"](#) on page 159

[:SOURce<hw>]:CORRection:DEXChange:AFILe:CATalog?

Requests a list of available ASCII files for export/import of user correction data. The individual files are separated by commas.

The ASCII files are stored with the fixed file extensions `*.txt` or `*.csv` in a directory of the user's choice. The directory applicable to the commands is defined with the command `MMEMoRY:CDIR`.

Return values:

<Catalog> string

Example:

```
MMEM:CDIR '/var/user/import'
selects the directory for the ASCII files with frequency and level
value pairs.
CORR:DEXC:AFIL:EXT TXT
selects that ASCII files with extension *.txt are listed.
CORR:DEXC:AFIL:CAT?
queries the available files with extension *.txt.
Response: 'ucor1,ucor2'
the ASCII files ucor1.txt and ucor2.txt are available.
```

Usage: Query only

[:SOURce<hw>]:CORRection:DEXChange:AFILe:EXTension <Extension>

Selects the file extension of the ASCII file to be imported or exported. Selection TXT (text file) or CSV (Excel file) is available.

Parameters:

<Extension> TXT | CSV
*RST: TXT

Example:

```
MMEM:CDIR '/var/user/import'
selects the directory for the ASCII files with frequency and level
value pairs.
CORR:DEXC:AFIL:EXT TXT
selects that ASCII files with extension *.txt are listed.
CORR:DEXC:AFIL:CAT?
queries the available files with extension *.txt.
Response: 'list1,list2'
the ASCII files ucor1.txt and ucor2.txt are available.
```

Manual operation: See "[Extension - User Correction](#)" on page 162

[:SOURce<hw>]:CORRection:DEXChange:AFILe:SElect <Filename>

Selects the ASCII file to be imported or exported.

The ASCII files are stored with the fixed file extensions *.txt or *.csv in a directory of the user's choice. The directory applicable to the commands is defined with the command `MMEMoRY:CDIR`. A path can also be specified in command `SOUR:CORR:DEXC:AFIL:SEL`, in which case the files are stored or loaded in the specified directory.

Parameters:

<Filename> <ascii file name>

Example:

```
CORR:DEXC:MODE IMP
selects that ASCII files with frequency and level value pairs are
imported and transferred into user correction lists.
CORR:DEXC:AFIL:SEL '/var/user/import_ucor.csv'
selects that ASCII file ucor.csv is imported.
CORR:DEXC:SEL '/var/user/import_ucor_imp'
selects that the ASCII file ucor.csv is imported into user cor-
rection list ucor_imp.
```

Manual operation: See "[Select ASCII Source / Destination - User Correction](#)" on page 162

[[:SOURce<hw>]:CORRection:DEXChange:AFILe:SEParator:COLumn <Column>

Selects the separator between the frequency and level column of the ASCII table.

Parameters:

<Column> TABulator | SEMicolon | COMMa | SPACe
*RST: COMMa

Example:

```
CORR:DEXC:MODE EXP
selects that the user correction list is exported into an ASCII file.
CORR:DEXC:AFIL:SEL '/var/user/import_ucor.csv'
selects ASCII file ucor.csv as destination for the user correction
list data.
CORR:DEXC:AFIL:SEP:COL TAB
the pairs of frequency and level values are separated by a tabu-
lator.
CORR:DEXC:AFIL:SEP:DEC DOT
selects the decimal separator dot.
CORR:DEXC:SEL '/var/user/import_ucor_imp'
selects that the user correction list ucor_imp is imported into
ASCII file ucor.csv.
```

Manual operation: See "[Column Separator- User Correction](#)" on page 162

[[:SOURce<hw>]:CORRection:DEXChange:AFILe:SEParator:DECimal <Decimal>

Selects the decimal separator used in the ASCII data between '.' (decimal point) and ',' (comma) with floating-point numerals.

Parameters:

<Decimal> DOT | COMMa
 *RST: DOT

Example:

CORR:DEXC:MODE EXP
 selects that the user correction list is exported into an ASCII file.
 CORR:DEXC:AFIL:SEL '/var/user/import_ucor.csv'
 selects ASCII file ucor.csv as destination for the user correction list data.
 CORR:DEXC:AFIL:SEP:COL TAB
 the pairs of frequency and level values are separated by a tabulator.
 CORR:DEXC:AFIL:SEP:DEC DOT
 selects the decimal separator dot.
 CORR:DEXC:SEL '/var/user/import_ucor_imp'
 selects that the user correction list ucor_imp is imported into ASCII file ucor.csv.

Manual operation: See "[Decimal Point - User Correction](#)" on page 162

[:SOURce<hw>]:CORRection:DEXChange:EXECute

Starts the export or import of the selected file. When import is selected, the ASCII file is imported as user correction list. When export is selected, the user correction list is exported into the selected ASCII file.

Example:

CORR:DEXC:MODE IMP
 selects that ASCII files with frequency and level value pairs are imported and transferred into user correction lists.
 CORR:DEXC:AFIL:SEL '/var/user/import_ucor.csv'
 selects that ASCII file ucor.csv is imported.
 CORR:DEXC:SEL '/var/user/import_ucor_imp'
 selects that the ASCII file ucor.csv is imported into user correction list ucor_imp.
 CORR:DEXC:EXEC
 starts the import of the ASCII file data into the user correction file.

Usage: Event

Manual operation: See "[Import / Export - User Correction](#)" on page 162

[:SOURce<hw>]:CORRection:DEXChange:MODE <Mode>

Selects if user correction lists should be imported or exported. Depending on the selection here, the file select command defines either the source or the destination for user correction lists and ASCII files.

Parameters:

<Mode> IMPort | EXPort
 *RST: IMPort

Example:

```
CORR:DEXC:MODE IMP
selects that ASCII files with frequency and level value pairs are
imported and transferred into user correction lists.
CORR:DEXC:AFIL:SEL '/var/user/ucor.csv'
selects that ASCII file ucor.csv is imported.
CORR:DEXC:SEL '/var/user/ucor_imp'
selects that the ASCII file ucor.csv is imported into user cor-
rection list ucor_imp.
```

Manual operation: See "[Mode - User Correction](#)" on page 161

[[:SOURce<hw>]:CORRection:DEXChange:SElect <Filename>

Selects the user correction list to be imported or exported.

The user correction files are stored with the fixed file extensions *.uco in a directory of the user's choice. The directory applicable to the commands is defined with the command `MMEMoRY:CDIR`. A path can also be specified in command `SOUR:CORR:DEXC:SEL`, in which case the files are stored or loaded in the specified directory.

Parameters:

<Filename> string

Example:

```
CORR:DEXC:MODE IMP
selects that ASCII files with frequency and level value pairs are
imported and transferred into user correction lists.
CORR:DEXC:AFIL:SEL '/var/user/import_ucor.csv'
selects that ASCII file ucor.csv is imported.
CORR:DEXC:SEL '/var/user/import_ucor_imp'
selects that the ASCII file ucor.csv is imported into user cor-
rection list ucor_imp.
```

Manual operation: See "[Destination / Source - User Correction](#)" on page 162

[[:SOURce<hw>]:CORRection:CSET[:SElect] <Filename>

Selects or creates a file for the user correction data.

If the file does not exist, the instrument automatically creates a new file with the name you assigned. Note the predefined file extensions under [Chapter 4.7.2.1, "Extensions for User Files"](#), on page 85.

To determine the file location (directory/path) you can either enter it with the command directly, or use the command `MMEMoRY:CDIR`.

To activate level correction use the command `[[:SOURce<hw>]:CORRection[:STATe]`.

Parameters:

<Filename> <table name>

Example: CORR:CSET '/var/user/ucor1'
selects the table ucor1.
CORR ON
activates level correction. Correction is performed using the
table ucor1.

Manual operation: See ["User Cor. Data - User Correction"](#) on page 159

[:SOURce<hw>]:CORRection[:STATe] <State>

Activates/deactivates level correction. Level correction is performed using the table which has been selected with the command [\[:SOURce<hw>\]:CORRection:CSET\[:SELEct\]](#).

Parameters:

<State> 0 | 1 | OFF | ON
*RST: 0

Example: SOUR:CORR:CSET '/var/user/ucor1'
selects the table ucor1.
SOUR:CORR ON
activates user correction.

Manual operation: See ["State - User Correction"](#) on page 159

[:SOURce<hw>]:CORRection:VALue?

Queries the current value for user correction.

Return values:

<Value> float
Range: -100 to 100
Increment: 0.01
*RST: 0

Example: CORR:VAL?
queries the value currently used for level correction.
Response: -3
the correction value is - 3 dB.

Usage: Query only

Manual operation: See ["User Correction Value - User Correction"](#) on page 159

[:SOURce<hw>]:CORRection:ZERoing:STATe <State>

Activates the zeroing procedure before filling the user correction data acquired by a sensor.

Parameters:

<State> 0 | 1 | OFF | ON

Manual operation: See ["Fill User Correction Data with Sensor"](#) on page 165

7.13.3 SOURce:FM Subsystem

The FM subsystem contains the commands for checking the frequency modulation.

Characteristics which are valid for all modulations and the LF Output are configured in the SOURce:LFOutput subsystem (e.g. frequency). The external signal is input at the MOD EXT connector.

For information about the required options, see [Chapter 5.4.3, "Frequency Modulation \(FM\)"](#), on page 202.

[:SOURce<hw>]:FM[:DEViation]	337
[:SOURce<hw>]:FM:EXTernal:COUPling	337
[:SOURce<hw>]:FM:EXTernal:DEViation	338
[:SOURce<hw>]:FM:INTernal:DEViation	338
[:SOURce<hw>]:FM:MODE	338
[:SOURce<hw>]:FM:SENSitivity?	339
[:SOURce<hw>]:FM:SOURce	339
[:SOURce<hw>]:FM:STATe	340

[:SOURce<hw>]:FM[:DEViation] <Deviation>

Sets the deviation of the frequency modulation signals in Hz. The maximum deviation depends on the set RF frequency and the selected modulation mode (see data sheet).

Parameters:

<Deviation> float
 Range: 0 to dynamic
 Increment: 0.01
 *RST: 1000

Example: FM 2E3
 sets a 2 kHz deviation to the modulation signal.

Manual operation: See "[FM Deviation](#)" on page 204

[:SOURce<hw>]:FM:EXTernal:COUPling <Coupling>

Selects the coupling mode for the external frequency modulation signal.

Parameters:

<Coupling> AC | DC
AC
 Uses only the AC signal component of the modulation signal.
DC
 Uses the modulation signal as it is, with AC and DC.
 *RST: AC

Example: FM:EXT:COUP AC
 selects the coupling mode AC for the external frequency modulation signal.

Manual operation: See "[FM External Coupling](#)" on page 205

[:SOURce<hw>]:FM:EXTernal:DEViation <Deviation>

Sets the deviation of the external frequency modulation signal in Hz. The maximum deviation depends on the set RF frequency and the selected modulation mode (see data sheet).

The sum of the deviations of all active frequency modulation signals may not exceed the total value set with command `[:SOURce<hw>]:FM[:DEViation]`.

Parameters:

<Deviation> float
 Range: see data sheet
 Increment: 0.01
 *RST: 1000

Example: `FM:EXT:DEV 3kHz`
 sets 3 kHz deviation to the frequency modulation signal.

Manual operation: See "[FM Deviation](#)" on page 204

[:SOURce<hw>]:FM:INTernal:DEViation <Deviation>

Sets the deviation of the internal frequency modulation signal in Hz.

The sum of the deviations of all active frequency modulation signals may not exceed the total value set with command `[:SOURce<hw>]:FM[:DEViation]`.

Parameters:

<Deviation> float
 Range: 0 to dynamic
 Increment: 0.01
 *RST: 1E3

Example: `FM:INT1:DEV 2E3`
 sets 2 kHz deviation for the frequency modulation signal.

Manual operation: See "[FM Deviation](#)" on page 204

[:SOURce<hw>]:FM:MODE <Mode>

Selects the mode for the frequency modulation.

Parameters:

<Mode>

NORMal | LNOise | HDEVIation

NORMal

Provides full setting range of modulation bandwidth and FM deviation.

LNOise

Provides phase noise and spurious characteristics close to CW. The range for modulation bandwidth and FM deviation is reduced (see data sheet).

HDEVIation

Provides full setting range for FM deviation. The range of modulation bandwidth is reduced (see data sheet).

*RST: NORM

Example:

FM:MODE NORM

selects normal mode for external frequency modulation.

Manual operation: See "FM Mode" on page 203

[:SOURce<hw>]:FM:SENSitivity?

Queries the input sensitivity of the externally applied signal for frequency modulation. The returned value reports the sensitivity in Hz/V. It is assigned to the voltage value for full modulation of the input signal.

The sensitivity depends on the set [:SOURce<hw>]:FM[:DEVIation].

Return values:

<Sensitivity>

float

Range: 0 to max

Increment: 0.01

Example:

FM:DEV 5E3

sets a modulation deviation of 5 kHz.

FM:SENS

queries the input sensitivity at the external modulation input.

Response: 5E3

since the voltage value for full modulation is 1V, the resulting sensitivity is precisely 5000 Hz/V.

Usage:

Query only

Manual operation: See "FM Sensitivity" on page 204

[:SOURce<hw>]:FM:SOURce <Source>

Selects the modulation signal source for frequency modulation.

Parameters:

<Source> INTernal | EXTernal | INT,EXT

INT

Uses the internally generated signal for modulation. To configure the frequency, use the commands of the [Chapter 7.13.6, "SOURce:LFOutput Subsystem"](#), on page 348 subsystem.

EXT

Uses an externally applied modulation signal. The external signal is input at the MOD EXT connector.

INT,EXT

Uses both, the internal and external modulation signals.

*RST: INT

Example:

```
FM:SOUR INT
selects the internal modulation source.
```

Manual operation: See ["FM Source"](#) on page 203

[:SOURce<hw>]:FM:STATe <State>

Activates frequency modulation.

Note: Activation of FM deactivates phase modulation (PM).

Parameters:

<State> 0 | 1 | OFF | ON

*RST: 0

Example:

```
FM:STAT ON
Activates FM modulation.
```

Manual operation: See ["State"](#) on page 203

7.13.4 SOURce:FREQuency Subsystem

This subsystem contains the commands used to define the frequency settings for the RF sources and sweeps.

[:SOURce<hw>]:FREQuency:CENTer	341
[:SOURce<hw>]:FREQuency[:CW FIXed]	341
[:SOURce<hw>]:FREQuency[:CW FIXed]:RCL	342
[:SOURce<hw>]:FREQuency:MANual	342
[:SOURce<hw>]:FREQuency:MODE	343
[:SOURce<hw>]:FREQuency:MULTiplier	344
[:SOURce<hw>]:FREQuency:OFFSet	344
[:SOURce<hw>]:FREQuency:SPAN	345
[:SOURce<hw>]:FREQuency:STARt	345
[:SOURce<hw>]:FREQuency:STOP	346
[:SOURce<hw>]:FREQuency:STEP[:INCRement]	346
[:SOURce<hw>]:FREQuency:STEP:MODE	347

[:SOURce<hw>]:FREQUENCY:CENTer <Center>

Sets the center frequency of the RF sweep range.

The range is defined by this center frequency and the specified `[:SOURce<hw>] : FREQUENCY:SPAN`, according to the formula:

$$f_{\text{CENTer}} - (f_{\text{SPAN}}/2) \dots f_{\text{CENTer}} + (f_{\text{SPAN}}/2)$$

with:

$$f_{\text{SPAN}} = f_{\text{STOP}} - f_{\text{START}}$$

The center frequency directly relates to the span, and the start and stop frequencies. If you change one of these parameters, the center frequency changes accordingly.

$$f_{\text{CENTer}} = (f_{\text{STOP}} + f_{\text{START}})/2$$

Note: You can select any frequency within the setting range. The range is defined with the parameters `[:SOURce<hw>] : FREQUENCY:START` and `[:SOURce<hw>] : FREQUENCY:STOP`.

A defined offset and the multiplier factor affect the sweep frequency range and therefore all correlated parameters. The set frequencies are only absolute values, if the offset = 0 and the multiplication factor = 1. The multiplier multiplies the frequencies accordingly, and the offset ≠ 0 shifts the frequencies corresponding to the set value.

$$300 \text{ kHz} * f_{\text{MULTIplier}} + f_{\text{OFFSet}} \dots f_{\text{max}} * f_{\text{MULTIplier}} + f_{\text{OFFSet}}$$

Parameters:

<Center>	float
Range:	full frequency range
Increment:	see the data sheet: RF characteristics > Resolution of setting
*RST:	depends on model

Example:

```
FREQ:CENT 400 MHz
sets the center frequency for the frequency sweep to 400 MHz.
FREQ:SPAN 200 MHz
sets a span of 200 MHz. This sets the sweep range to 300 MHz
to 500 MHz.
```

Manual operation: See "[Center Freq - Frequency Sweep](#)" on page 179

[:SOURce<hw>]:FREQUENCY[:CW|FIXed] <Fixed>

Sets the frequency of the RF output signal.

In CW mode, see `FREQ:MODE CW|FIXed`, the instrument operates at a fixed frequency.

In sweep mode `FREQ:MODE SWE`, the value applies to the sweep frequency and the instrument processes the frequency settings in defined sweep steps.

You can enter either a numerical frequency value, or decrease or increase the current frequency step by step with **FREQ UP** and **FREQ DOWN**. The frequency is then increased or decreased by the value `[:SOURce<hw>] :FREQuency:STEP [:INCRement]` in **FREQ:STEP:MODE USER**.

Note:

A defined offset and the multiplier factor affect the sweep range and therefore all correlated parameters. The set frequencies are only absolute values, if the offset = 0 and the multiplication factor = 1. The multiplier multiplies the frequencies accordingly, and the offset ≠ 0 shifts the frequencies corresponding to the set value.

The actual frequency at the RF output does not change, but rather the value queried with `[:SOUR]:FREQ?`, according to the formula:

$$f_{\text{FREQ}} = f_{\text{RFout}} * f_{\text{MULTIplier}} + f_{\text{OFFSet}}$$

Correlation: `FREQ` for `FREQ:MODE SWE` is linked to the sweep frequency.

Parameters:

<Fixed>	float
Range:	full frequency range
Increment:	see the data sheet: RF characteristics > Resolution of setting
*RST:	100 MHz

Example: `FREQ 500kHz`
sets the frequency of RF output signal A to 500 kHz.

Manual operation: See "**RF Freq**" on page 138

[:SOURce<hw>] :FREQuency [:CW|FIXed] :RCL <Rcl>

Determines whether the RF frequency value is retained or taken from a loaded instrument configuration, when you recall instrument settings with the command `*RCL`.

Parameters:

<Rcl>	INCLude EXCLude
	INCLude Takes the frequency value of the loaded settings.
	EXCLude Retains the current frequency when an instrument configuration is loaded.
*RST:	INCLude

Example: `FREQ:RCL INCL`
takes the frequency from the loaded instrument configuration.

Manual operation: See "**Exclude Frequency**" on page 129

[:SOURce<hw>] :FREQuency:MANual <Manual>

Determines the frequency and triggers a sweep step manually in **SWE:MODE MAN**.

Note: You can select any frequency within the setting range. The range is defined with the parameters `[:SOURce<hw>] :FREQuency:STARt` and `[:SOURce<hw>] :FREQuency:STOP`. A defined offset and the multiplier factor affect the sweep range and therefore all correlated parameters. The set frequencies are only absolute values, if the offset = 0 and the multiplication factor = 1. The multiplier multiplies the frequencies accordingly, and the offset ≠ 0 shifts the frequencies corresponding to the set value.

$$f_{\text{START}} * f_{\text{MULTIplier}} + f_{\text{OFFset}} \dots f_{\text{STOP}} * f_{\text{MULTIplier}} + f_{\text{OFFset}}$$

Parameters:

<Manual> float
 Range: full frequency range
 Increment: see the data sheet: RF characteristics > Resolution of setting

Example: `SWE:MODE MAN`
 sets the Step sweep mode.

Example: `FREQ:MODE SWE`
 sets the frequency sweep mode. The sweep start frequency is output.
`FREQ:MAN UP`
 triggers the next higher sweep step.
`FREQ:MAN 500MHz`
 outputs 500 MHz RF frequency (must e within the sweep frequency range).
`FREQ:MAN DOWN`
 triggers the next lower sweep step relative to 500 MHz.

Manual operation: See "[Current Freq - Frequency Sweep](#)" on page 179

[:SOURce<hw>] :FREQuency:MODE <Mode>

Selects the frequency mode for the generating the RF output signal. The selected mode determines the parameters to be used for further frequency settings.

Parameters:

<Mode>

CW | FIXed | SWEep | LIST

CW|FIXed

Sets the fixed frequency mode.

CW and FIXed are synonyms. The instrument operates at a defined frequency, set with command `[:SOURce<hw>] :FREQuency [:CW | FIXed] ..`

SWEep

Sets the sweep mode. The instrument processes the frequency settings in defined sweep steps. To determine the corresponding frequency values, use the commands `[:SOURce<hw>] :FREQuency:START` and `[:SOURce<hw>] :FREQuency:STOP`,

or `[:SOURce<hw>] :FREQuency:CENTer` and `[:SOURce<hw>] :FREQuency:SPAN` and `[:SOURce<hw>] :FREQuency:MANual`.

LIST

Sets the list mode. The instrument processes the frequency and level settings by means of values loaded from a list.

To configure the list mode settings use the commands of the [SOURce:LIST Subsystem](#)

*RST: CW

Example:

```
FREQ:MODE SWE
```

sets the SWEep mode.

Manual operation: See "[State - Frequency Sweep](#)" on page 176

[:SOURce<hw>] :FREQuency:MULTiplier <Multiplier>

Sets the value for the multiplication factor of a subsequent downstream instrument.

Parameters:

<Multiplier>

float

Range: 1 to dynamic

Increment: 0.001

*RST: 1

Example:

```
FREQ:MULT 1
```

sets the multiplication factor to 1.

Manual operation: See "[Multiplier](#)" on page 139

[:SOURce<hw>] :FREQuency:OFFSet <Offset>

Sets the frequency offset of a downstream instrument, for example a mixer.

If you have specified an OFFSet and / or a MULTiplier factor, the actual frequency at the RF output does not change, but rather the value queried with `[:SOUR] :FREQu?`, according to the following formula:

$$f_{\text{FREQ}} = f_{\text{RFout}} * f_{\text{MULTiplier}} + f_{\text{OFFSet}}$$

Parameters:

<Offset> float
 Increment: 0.01
 *RST: 0

Example: `FREQ:OFFS 500kHz`
 sets the frequency offset to 500 kHz.

Manual operation: See "[Offset](#)" on page 139

**[:SOURce<hw>]:FREQuency:SPAN **

Determines the extent of the frequency sweep range. This setting in combination with the center frequency setting (`[:SOURce<hw>] :FREQuency:CENTer`) defines the sweep range.

This parameter is related to the start and stop frequencies. If you change the frequency, the span changes accordingly.

$$f_{\text{SPAN}} = f_{\text{STOP}} - f_{\text{START}}$$

$f_{\text{START}} > f_{\text{STOP}}$ is permitted.

Parameters:

 float
 Range: full frequency range
 Increment: see the data sheet: RF characteristics > Resolution of setting
 *RST: 400E6

Example: `FREQ:CENT 400 MHz`
 sets the center frequency of the frequency sweep to 400 MHz.
`FREQ:SPAN 200 MHz`
 sets a span of 200 MHz. This sets the sweep range to 300 MHz to 500 MHz.

Manual operation: See "[Span - Frequency Sweep](#)" on page 179

[:SOURce<hw>]:FREQuency:STARt <Start>

Sets the start frequency for the RF sweep.

This parameter relates to the center frequency and span. If you change the frequency, these parameters change accordingly.

$f_{\text{START}} > f_{\text{STOP}}$ is permitted.

$$f_{\text{START}} = (f_{\text{CENTer}} - f_{\text{SPAN}}/2).$$

Note: A defined offset and the multiplier factor affect the sweep range and therefore all correlated parameters. The set frequencies are only absolute values, if the offset = 0 and the multiplication factor = 1. The multiplier multiplies the frequencies accordingly, and the offset $\neq 0$ shifts the frequencies corresponding to the set value.

$$f_{\text{START}} * f_{\text{MULTIplier}} + f_{\text{OFFset}} \dots f_{\text{STOP}} * f_{\text{MULTIplier}} + f_{\text{OFFset}}$$

Parameters:

<Start> float
 Range: full frequency range
 Increment: see the data sheet: RF characteristics > Resolution of setting
 *RST: 100 MHz

Example:

FREQ:START 1 MHz
 sets the start frequency for the frequency sweep to 1 MHz.
 FREQ:STOP 2 GHz
 sets the stop frequency for the frequency sweep to 2 GHz.

Manual operation: See ["Start Freq - Frequency Sweep"](#) on page 178

[[:SOURce<hw>]:FREQUENCY:STOP <Stop>

Sets the stop frequency for the RF sweep.

This parameter is related to the center frequency and span. If you change the frequency, these parameters change accordingly.

$f_{\text{START}} > f_{\text{STOP}}$ is permitted.

$$f_{\text{STOP}} = (f_{\text{CENTER}} + f_{\text{SPAN}}/2).$$

Note: A defined offset affects the sweep range and consequently all correlating parameters. The set frequencies are only absolute values, if the Offset = 0. Offset ≠ 0 shifts the frequencies according to the offset value.

$$f_{\text{START}} * f_{\text{MULTIplier}} + f_{\text{OFFset}} \dots f_{\text{STOP}} * f_{\text{MULTIplier}} + f_{\text{OFFset}}$$

Parameters:

<Stop> float
 Range: full frequency range
 Increment: see the data sheet: RF characteristics > Resolution of setting
 *RST: 500 MHz

Example:

FREQ:STOP 2 GHz
 sets the stop frequency for the frequency sweep to 2 GHz.
 FREQ:STAR 1 MHz
 sets the start frequency for the frequency sweep to 1 MHz.

Manual operation: See ["Stop Freq - Frequency Sweep"](#) on page 179

[[:SOURce<hw>]:FREQUENCY:STEP[:INCREMENT] <Increment>

Sets the step width for [FREQ:STEP:MODE USER](#).

To adjust the frequency step by step with this step size, use the `FREQ:UP` and `FREQ:DOWN` commands.

Note: This value also applies to the step width of the rotary knob of the instrument and increases or decreases the frequency accordingly, when you work in user-defined step mode.

Parameters:

<Increment> float
 Range: full frequency range
 Increment: see the data sheet: RF characteristics > Resolution of setting
 *RST: 1E6

Example: `FREQ:STEP 50 kHz`
 sets the step width for the frequency setting to 50 kHz.

Manual operation: See "[Variation Step](#)" on page 140

[[:SOURce<hw>]:FREQuency:STEP:MODE <Mode>

Activates (USER) or deactivates (DECimal) the user-defined step width used when varying the frequency value with the frequency values UP/DOWN. The command is linked to the command "Variation Active" for manual control, i.e. the command also activates/deactivates the user-defined step width used when varying the frequency value with the rotary knob.

Parameters:

<Mode> DECimal | USER
 *RST: DECimal

Example: `FREQ:STEP 50 kHz`
 sets the step width for the frequency setting to 50 kHz.
`FREQ:STEP:MODE USER`
 activates this step width for frequency variation with the rotary knob (manual control) and with frequency values UP/DOWN (remote control).

Manual operation: See "[Variation Active](#)" on page 140

7.13.5 SOURce:INPut Subsystem

The SOURce:INPut subsystem contains the commands for configuring the inputs for external modulation signals. The instrument trigger setting influences all sweeps and is effective in the List mode (Instrument Trigger).

[:SOURce<hw>]:INPut:MODext:IMPedance	347
[:SOURce<hw>]:INPut:MODext:WIGNore	348
[:SOURce]:INPut:TRIGger:SLOPe	348

[[:SOURce<hw>]:INPut:MODext:IMPedance <Impedance>

Sets the impedance for an externally applied modulation signal.

Parameters:

<Impedance> HIGH | G600
HIGH
 > 100 kOhm to ground
 *RST: HIGH

Example:

INP:MOD:IMP HIGH
 sets > 100 kOhm to ground.

Manual operation: See "[Ext. Impedance](#)" on page 201

[[:SOURce<hw>]:INPut:MODext:WIGNore <SuppressState>

Ignores warnings concerning an overload of the modulation signal input.

This setting is not affected by an instrument preset *rst or the and Save/Recall function. Only the factory preset resets this setting.

Parameters:

<SuppressState> 0 | 1 | OFF | ON
 *RST: 0

Example:

INP:MOD:WIGN ON
 suppresses the overvoltage warnings.

Manual operation: See "[Ignore Overvoltage Warning](#)" on page 202

[[:SOURce]:INPut:TRIGger:SLOPe <Slope>

Sets the polarity of the active slope of an externally applied trigger signal at the trigger input (BNC connector at the rear of the instrument).

The setting is effective for both inputs at the same time.

Parameters:

<Slope> NEGative | POSitive
 *RST: POSitive

Example:

INP:TRIG:SLOP NEG
 Activates the falling slope of the external trigger signal at the trigger input.

Manual operation: See "[Ext. Trigger Input Slope](#)" on page 182

7.13.6 SOURce:LFOutput Subsystem

The SOURce:LFOutput subsystem contains the commands for setting the LF signal source in CW and Sweep mode and for analog modulation.

Example

The following example shows how to set an LF sweep.

1. Set the sweep range.
 LFOutput:FREQUENCY:START 4 kHz
 LFOutput:FREQUENCY:STOP 10 kHz
2. Select linear or logarithmic sweep spacing.
 LFOutput:SWEep[:FREQUENCY]:SPACing LIN
3. Set the step width and dwell time.
 LFOutput:SWEep[:FREQUENCY]:STEP[:LINear] 100 Hz
 LFOutput:SWEep[:FREQUENCY]:DWELL 20 ms
4. Determine the sweep mode.
 LFOutput:SWEep:MODE AUTO
5. Determine the trigger.
 TRIGger0:SOURce SINGle
6. Activate the sweep.
 LFOutput:FREQUENCY:MODE SWEep
7. Trigger the sweep (depending on the mode).
 LFOutput:SWEep:EXECute

[:SOURce]:LFOutput<ch>:FREQUENCY	349
[:SOURce<hw>]:LFOutput:FREQUENCY:MANual	350
[:SOURce<hw>]:LFOutput:FREQUENCY:MODE	350
[:SOURce<hw>]:LFOutput:FREQUENCY:START	351
[:SOURce<hw>]:LFOutput:FREQUENCY:STOP	351
[:SOURce]:LFOutput[:STATE]	352
[:SOURce<hw>]:LFOutput:SWEep[:FREQUENCY]:DWELL	352
[:SOURce<hw>]:LFOutput:SWEep[:FREQUENCY]:EXECute	352
[:SOURce<hw>]:LFOutput:SWEep[:FREQUENCY]:MODE	353
[:SOURce<hw>]:LFOutput:SWEep[:FREQUENCY]:POINTs	353
[:SOURce<hw>]:LFOutput:SWEep[:FREQUENCY]:RETRace	354
[:SOURce<hw>]:LFOutput:SWEep[:FREQUENCY]:RUNNING?	355
[:SOURce<hw>]:LFOutput:SWEep[:FREQUENCY]:SHAPE	355
[:SOURce<hw>]:LFOutput:SWEep[:FREQUENCY]:SPACing	355
[:SOURce<hw>]:LFOutput:SWEep[:FREQUENCY]:STEP[:LINear]	356
[:SOURce<hw>]:LFOutput:SWEep[:FREQUENCY]:STEP:LOGarithmic	357
[:SOURce]:LFOutput:SHAPE	357
[:SOURce]:LFOutput:SIMPedance	358
[:SOURce]:LFOutput:VOLTage	358

[\[:SOURce\]:LFOutput<ch>:FREQUENCY](#) <Frequency>

Sets the frequency of the LF signal in [LFO:FREQ:MODE CW|FIXed](#) mode.

Note:

- If signal source "Internal" is set, the instrument performs the analog modulations (AM/FM/φM/PM) with this frequency.
- In sweep mode ([LFO:FREQ:MODE SWEp](#)), the frequency is coupled with the sweep frequency.

Parameters:

<Frequency> float
 Range: full frequency range
 Increment: see the data sheet: Modulation sources > Resolution of frequency setting
 *RST: 1000

Example:

`LFO2:FREQ 5kHz`
 sets the frequency of the LF generator 2 signal to 5 kHz.

Manual operation: See "[LF Gen Freq](#)" on page 200

[:SOURce<hw>]:LFOOutput:FREQuency:MANual <Manual>

Determines the frequency and triggers the next sweep step manually in [LFO:SWE\[:FREQ\]:MODE MAN](#), and [LFO:SWE\[:FREQ\]:MODE STEP](#).

Note: You can select any frequency within the setting range. The range is defined with [LFO:FREQ:START](#) and [LFO:FREQ:STOP](#).

Parameters:

<Manual> float
 Range: full frequency range
 Increment: see the data sheet: Modulation sources > Internal modulation generator > Resolution of frequency setting
 *RST: 1000

Example:

`LFO:SWE:MODE MAN`
 sets the "Step" sweep mode.
`LFO:FREQ:MAN 5 kHz`
 sets an LF frequency of 5 kHz for the next step in the "Step" sweep mode.
`LFO:FREQ:MODE SWE`
 sets the LF Sweep mode. An LF frequency of 5 kHz is output.
`LFO:FREQ:MAN 5.1 kHz`
 triggers the next sweep step with a frequency of 5.1 kHz.

Manual operation: See "[Current Freq](#)" on page 224

[:SOURce<hw>]:LFOOutput:FREQuency:MODE <Mode>

Sets the instrument operating mode, and determines the commands to be used for frequency settings.

Parameters:

<Mode>

CW | FIXed | SWEep

CW|FIXed

Sets the CW frequency mode. CW and FIXed are synonyms.

The instrument operates at a fixed frequency. To set the LF output frequency, use the command [:SOURce]:

LFOutput<ch>:FREQuency.

SWEep

Sets the sweep mode.

The instrument processes the frequency settings in defined sweep steps. To determine the corresponding frequency values, use the commands [:SOURce<hw>]:LFOutput:FREQuency:START, [:SOURce<hw>]:LFOutput:FREQuency:STOP or [:SOURce<hw>]:LFOutput:FREQuency:MANual.

*RST: CW

Example:

LFO:FREQ:MODE SWE

sets the sweep mode.

Manual operation: See "State" on page 221**[:SOURce<hw>]:LFOutput:FREQuency:START <Start>**

Sets the start frequency for the LF sweep.

Parameters:

<Start>

float

Range: full frequency range

Increment: see the data sheet: Resolution of frequency setting

*RST: 1 KHz

Example:

RST*

activates all presettings.

LFO:SWE:MODE AUTO

TRIGO:SOUR SING

LFO:FREQ:STAR 1 kHz

LFO:FREQ:STOP 10 kHz

LFO:FREQ:MODE SWE

LFO:SWE:EXEC

the instrument generates a single sweep cycle from 1 kHz to 10 kHz automatically after a manual trigger event occurs

(:LFOutput:SWEep:EXECute or *TRG). The step width is 1 kHz linear, with 15 ms dwell time until the signal switches to the subsequent step.

Manual operation: See "Start Freq" on page 224**[:SOURce<hw>]:LFOutput:FREQuency:STOP <Stop>**

Sets the stop frequency for the LF sweep.

Parameters:

<Stop> float
 Range: full frequency range
 Increment: see the data sheet: resolution of frequency setting
 *RST: 100 KHz

Example:

LFO:FREQ:STOP 10 kHz
 sets the stop frequency for the LF sweep to 10 kHz.

Manual operation: See "[Stop Freq](#)" on page 224

[[:SOURce]:LFOOutput[:STATe] <State>

Activates/deactivates the LF output.

Parameters:

<State> 0 | 1 | OFF | ON
 *RST: 0

Example:

LFO ON
 activates the LF output. The settings under LFO:FREQ and LFO:SWE become effective.

Manual operation: See "[LF Output State](#)" on page 219

[[:SOURce<hw>]:LFOOutput:SWEep[:FREQUENCY]:DWELl <Dwell>

Sets the dwell time for each frequency step of the sweep.

Tip: It is recommended to switch off the "Display Update" for optimum sweep performance especially with short dwell times ([SYSTem:DISPlay:UPDate OFF](#)).

Parameters:

<Dwell> float
 Range: see data sheet: Dwell time setting range
 Increment: 100E-6
 *RST: 15E-3

Example:

LFO:SWE:DWEL 20 ms
 sets a dwell time of 20 ms.

Manual operation: See "[Dwell Time - LF Sweep](#)" on page 225

[[:SOURce<hw>]:LFOOutput:SWEep[:FREQUENCY]:EXECute

Immediately starts an LF frequency sweep in [LFO:SWE:MODE SINGLE](#).

Example:

LFO:SWE:MODE SING
 sets the single cycle mode of the LF sweep.
 LFO:SWE:EXEC
 starts one cycle of the LF sweep.

Usage: Event

Manual operation: See "Execute Single Sweep" on page 223

[:SOURce<hw>]:LFOOutput:SWEep[:FREQUENCY]:MODE <Mode>

Sets the cycle mode of the LF sweep.

The assignment of the GPIB commands to the sweep modes is given in the description of the sweep dialogs.

Parameters:

<Mode>

AUTO | MANual | STEP

AUTO

Performs a complete sweep cycle from the start to the end value when a trigger event occurs.

The dwell time determines the time period for the signal to switch to the next step.

MANual

Performs a single sweep step when a manual trigger event occurs.

The trigger system is not active. You can trigger each frequency step of the sweep individually with the command [:SOURce<hw>]:LFOOutput:FREQUENCY:MANual. In manual mode, use the rotary knob for switching to the next step.

With each step, the frequency increases by the value specified with the command [:SOURce<hw>]:LFOOutput:SWEep[:FREQUENCY]:STEP[:LINear] or [:SOURce<hw>]:LFOOutput:SWEep[:FREQUENCY]:STEP:LOGarithmic, respectively. A frequency value, entered with [:SOURce<hw>]:LFOOutput:FREQUENCY:MANual takes no effect.

With manual control, the frequency increases or decreases (depending on the direction of the rotary encoder) by the value specified under SOUR:LFO:SWE:FREQ:STEP:LIN (linear spacing) or . . . :STEP:LOG (logarithmic spacing).

STEP

Each trigger triggers one sweep step only. The frequency increases by the value entered with [:SOURce<hw>]:LFOOutput:SWEep[:FREQUENCY]:STEP[:LINear] or [:SOURce<hw>]:LFOOutput:SWEep[:FREQUENCY]:STEP:LOGarithmic.

*RST: AUTO

Example:

LFO:SWE:MODE AUTO
selects Auto mode.

Manual operation: See "Mode" on page 221

[:SOURce<hw>]:LFOOutput:SWEep[:FREQUENCY]:POINTS <Points>

Determines the number of steps for the LF frequency sweep within the sweep range.

This parameter always applies to the currently set sweep spacing and correlates with the step size as follows:

- for linear sweeps and $f_{\text{START}} < f_{\text{STOP}}$
 $\text{freq_points} = (f_{\text{SPAN}} / \text{step_lin}) + 1$
with $f_{\text{SPAN}} = f_{\text{STOP}} - f_{\text{START}}$
To determine the step size, use the command [SWE:STEP\[LIN\]](#).
- logarithmic sweeps and $f_{\text{START}} < f_{\text{STOP}}$
 $\text{freq_points} = ((\log f_{\text{STOP}} - \log f_{\text{START}}) / \log \text{step_log}) + 1$
To determine the logarithmic step size, use the command [SWE:STEP:LOG](#).

If you change the number of sweep points, the step size changes accordingly. The sweep range remains the same.

Each sweep spacing mode has assigned the `POINTS` setting separately. Thus, the command refers always to the particular set mode, see [\[:SOURce<hw>\]:LFOOutput:SWEep\[:FREQUENCY\]:SPACing](#).

Parameters:

<Points> integer
Range: 2...max

Example:

```
LFO:FREQ:STAR
sets the start frequency to 2 kHz.
LFO:FREQ:STOP
sets the stop frequency to 20 kHz
LFO:SWE:SPAC LIN
sets linear sweep spacing.
LFO:SWE:POIN 11
sets 11 sweep steps for linear sweep spacing. The sweep step
width (STEP) is automatically set to 2 kHz.
```

[\[:SOURce<hw>\]:LFOOutput:SWEep\[:FREQUENCY\]:RETRace <State>](#)

Activates that the signal changes to the start frequency value while it is waiting for the next trigger event.

You can enable this feature, when you are working with sawtooth shapes in sweep mode "Single" or "External Single".

Parameters:

<State> 0 | 1 | OFF | ON
*RST: 0

Example:

```
TRIGO:SWE:SOUR SING
LFO:SWE:MODE SWE
LFO:SWE:SHAP SAWT
LFO:SWE:RETR ON
activates retrace function, that means the frequency changes to
the value at start frequency while waiting for the next trigger
event.
```

Manual operation: See ["Retrace - LF Frequency Sweep"](#) on page 225

[[:SOURce<hw>]:LFOOutput:SWEep[:FREQUENCY]:RUNNING?

Queries the current status of the LF frequency sweep mode.

Return values:

<State> 0 | 1 | OFF | ON

Example:

LFO:SWE:RUNN?

Response "1": the frequency sweep is running.

Usage:

Query only

[[:SOURce<hw>]:LFOOutput:SWEep[:FREQUENCY]:SHAPE <Shape>

Sets the cycle mode for a sweep sequence (shape).

Parameters:

<Shape> SAWTooth | TRIangle

SAWTooth

A sweep runs from the start to the stop frequency. A subsequent sweep starts at the start frequency, that means the shape of the sweep sequence resembles a sawtooth.

TRIangle

A sweep runs from the start to the stop frequency and back, that means the shape of the sweep resembles a triangle. A subsequent sweep starts at the start frequency.

*RST: SAWTooth

Example:

SOUR:LFO:SWE:SHAP TRI

selects the sweep cycle with alternating ascending and descending sweep directions.

Manual operation: See "[Shape](#)" on page 224

[[:SOURce<hw>]:LFOOutput:SWEep[:FREQUENCY]:SPACING <Spacing>

Selects the mode for the calculation of the frequency sweep intervals. The frequency increases or decreases by this value at each step.

Parameters:

<Spacing> LINear | LOGarithmic

LINear

With the linear sweep, the step width is a fixed frequency value which is added to the current frequency. The step width for linear sweep is entered in Hz (see [:SOURce<hw>]:LFOOutput:SWEep[:FREQUENCY]:STEP[:LINear] on page 356).

LOGarithmic

With the logarithmic sweep, the step width is a constant fraction of the current frequency. This fraction is added to the current frequency. The logarithmic step width is entered in % (see [:SOURce<hw>]:LFOOutput:SWEep[:FREQUENCY]:STEP:LOGarithmic on page 357).

*RST: LINear

Example:

```
LFO:SWE:SPAC LIN
selects linear sweep spacing.
```

Manual operation: See "Spacing" on page 224**[[:SOURce<hw>]:LFOOutput:SWEep[:FREQUENCY]:STEP[:LINear] <Linear>**

Sets the step size for linear LF frequency sweep steps.

This parameter correlates with the number of steps [:SOURce<hw>]:LFOOutput:SWEep[:FREQUENCY]:POINTs within the sweep range as follows:

$$f_{\text{START}} < f_{\text{STOP}}$$

$$\text{freq_points} = ((f_{\text{START}} - f_{\text{STOP}}) / \text{step_lin}) + 1$$

If you change the step size, the number of steps changes accordingly. The sweep range remains the same.

Parameters:

<Linear>

float

Range: full frequency range

Increment: see the data sheet: Modulation sources > Resolution of frequency setting

*RST: 1000

Example:

```
LFO:FREQ:STAR
sets the start frequency to 2 kHz.
LFO:FREQ:STOP
sets the stop frequency to 20 kHz.
LFO:SWE:SPAC LIN
sets linear sweep spacing.
LFO:SWE:STEP 2 kHz
sets the sweep step width to 2 kHz. The number of sweep steps
for linear sweep spacing (POINTs) is automatically set to 11.
```

Manual operation: See "Step Lin/Log - LF Sweep" on page 225

[:SOURce<hw>]:LFOOutput:SWEep[:FREQUENCY]:STEP:LOGarithmic
 <Logarithmic>

Sets the logarithmically determined sweep step size for the LF frequency sweep. It is expressed in percent and you must enter the *value* and the unit *PCT* with the command.

The frequency is increased by a logarithmically calculated fraction of the current frequency according to:

$$\text{step_log}_{\text{step}+1} = f_{\text{step}} + \text{step_log}_{\text{step}} \times f_{\text{step}}$$

$$f_{\text{step}+1} = f_{\text{step}} + \text{step_log}_{\text{step}+1}$$

with $f_{\text{START}} < f_{\text{STOP}}$ and *step* = the current number of the sweep steps

This parameter correlates with the number of steps `LFO:SWE[:FREQ]:POIN` within the sweep range as follows:

$$\text{freq_points} = ((\log f_{\text{STOP}} - \log f_{\text{START}}) / \log \text{step_log}) + 1$$

If you change the step size, the number of steps changes accordingly. The sweep range remains the same.

Parameters:

<Logarithmic> float
 Range: 0.01 to 100
 Increment: 0.01
 *RST: 1

Example:

```
LFO:FREQ:STAR
sets the start frequency to 1 kHz.
LFO:FREQ:STOP
sets the stop frequency to 100 kHz.
LFO:SWE:SPAC LOG
sets logarithmic sweep spacing.
LFO:SWE:STEP:LOG 10PCT
sets the step width for logarithmic sweep spacing to 10% of the
previous frequency in each instance.
```

Manual operation: See "[Step Lin/Log - LF Sweep](#)" on page 225

[:SOURce]:LFOOutput:SHAPE <Shape>

Selects the shape of the LF signal.

Note: The installed hardware determines the available settings. Use the [Hardware Config](#) dialog to check the hardware the instrument is equipped with.

For information on the required hardware revision, refer to the release notes.

Parameters:

<Shape> SINE | SQUARE | TRIangle | SAWTooth | ISAWtooth
 *RST: SINE

2. Fill the list with values.

All list components must be of the same length. This does not apply to components of length 1. This is interpreted as if the component has the same length as the other components and as if all values are the same as the first value.

```
SOURce1:LIST:FREQ 100 MHz, 110 MHz, 120 MHz...
```

```
SOURce1:LIST:POW 2dBm, -1dBm, 0dBm...
```

3. Select a list.

If a new empty file has been created with the `:LIST:SEL` command, this file is selected, otherwise an existing list must be selected before the List mode is activated.

```
SOURce1:LIST:SEL "Old_list"
```

4. Set the dwell time.

The dwell time determines the duration of the individual list steps.

```
SOURce1:LIST:DWELL 3ms
```

5. Set the List mode.

The List mode determines the way in which the list is processed. In the example the list is processed once only or repeatedly depending on the trigger setting.

```
SOURce1:LIST:MODE AUTO
```

6. Determine the trigger.

In the example each trigger causes the list to be processed once from beginning to end.

```
SOURce:LIST:TRIGger:SOURce SINGLE
```

7. Activate the List mode.

```
SOURce1:FREQuency:MODE LIST
```

8. Trigger the list (depending on the mode).

```
SOURce1:LIST:TRIGger:EXECute
```

9. Deactivate the List mode.

```
SOURce1:FREQuency:MODE CW
```



SCPI refers to the individual lists as segments.

<code>[:SOURce<hw>]:LIST:CATalog?</code>	360
<code>[:SOURce<hw>]:LIST:DELete</code>	360
<code>[:SOURce<hw>]:LIST:DELete:ALL</code>	361
<code>[:SOURce<hw>]:LIST:DEXChange:AFILe:CATalog?</code>	361
<code>[:SOURce<hw>]:LIST:DEXChange:AFILe:EXTension</code>	362
<code>[:SOURce<hw>]:LIST:DEXChange:AFILe:SElect</code>	362
<code>[:SOURce<hw>]:LIST:DEXChange:AFILe:SEParator:COLumn</code>	363
<code>[:SOURce<hw>]:LIST:DEXChange:AFILe:SEParator:DECimal</code>	363
<code>[:SOURce<hw>]:LIST:DEXChange:EXECute</code>	363
<code>[:SOURce<hw>]:LIST:DEXChange:MODE</code>	364
<code>[:SOURce<hw>]:LIST:DEXChange:SElect</code>	364

<code>[:SOURce<hw>]:LIST:DWELl</code>	365
<code>[:SOURce<hw>]:LIST:FREE?</code>	365
<code>[:SOURce<hw>]:LIST:FREQUency</code>	365
<code>[:SOURce<hw>]:LIST:FREQUency:POINts?</code>	366
<code>[:SOURce<hw>]:LIST:INDex</code>	366
<code>[:SOURce<hw>]:LIST:INDex:START</code>	367
<code>[:SOURce<hw>]:LIST:INDex:STOP</code>	367
<code>[:SOURce<hw>]:LIST:LEARn</code>	368
<code>[:SOURce<hw>]:LIST:MODE</code>	368
<code>[:SOURce<hw>]:LIST:POWEr</code>	368
<code>[:SOURce<hw>]:LIST:POWEr:POINts?</code>	369
<code>[:SOURce<hw>]:LIST:RESet</code>	369
<code>[:SOURce<hw>]:LIST:SElect</code>	370
<code>[:SOURce<hw>]:LIST:TRIGger:EXECute</code>	370
<code>[:SOURce<hw>]:LIST:TRIGger:SOURce</code>	370

`[:SOURce<hw>]:LIST:CATalog?`

Requests a list of available lists. The individual lists are separated by commas.

The lists are stored with the fixed file extensions `*.lsw` in a directory of the user's choice. The directory applicable to the commands is defined with the command `MMEMoRY:CDIR`.

Return values:

<Catalog> string

Example:

```
MMEM:CDIR '/var/Listmode'
selects the directory for the list mode files.
LIST:CAT?
queries the available lists.
Response: 'list1,list2'
the lists list1 and list2 are available.
```

Usage: Query only

`[:SOURce<hw>]:LIST:DELeTe <Filename>`

Deletes the specified list.

The files are stored with the fixed file extensions `*.lsw` in a directory of the user's choice. The directory applicable to the command is defined with the command `MMEMoRY:CDIR`. To access the files in this directory, only the file name has to be given, without the path and the file extension. A path can also be specified in command `:SOUR:LIST:CAT?`, in which case the file in the specified directory is deleted.

*RST does not affect data lists.

Setting parameters:

<Filename> string

Example: MMEM:CDIR '/var/Listmode'
selects the directory for the list mode files.
LIST:DEL 'LIST1'
deletes the list list1.

Usage: Setting only

Manual operation: See "[List Mode Data... - List Mode](#)" on page 191

[[:SOURce<hw>]:LIST:DELeTe:ALL

Deletes all lists in the selected directory.

Note: The list mode must be previously disabled to make sure that no records are selected when you set the frequency mode (`[[:SOURce<hw>]:FREQuency:MODE]`).

The files are stored with the fixed file extensions *.lsw in a directory of the user's choice. You can select the directory with the commands `:MMEMory:CDIRectory` or `[[:SOURce<hw>]:LIST:CATalog?`.

*RST does not affect data lists.

Example: MMEM:CDIR '/var/Listmode'
selects the directory for the list mode files.
FREQ:MODE SWE
deactivates the list mode for RF output and activates the sweep mode.
LIST:DEL:ALL
deletes all list mode files in the selected directory.

Usage: Event

Manual operation: See "[List Mode Data... - List Mode](#)" on page 191

[[:SOURce<hw>]:LIST:DEXChange:AFILe:CATalog?

Queries the available ASCII files for export or import of list mode data in the current or specified directory.

As response, you get a string containing the existing ASCII files *.txt or *.csv, separated by commas.

Return values:

<Catalog> string

Example: MMEM:CDIR '/var/import'
selects the directory for the ASCII files with frequency and level value pairs.
LIST:DEXC:AFIL:EXT TXT
determines the extension *.txt for the query.
LIST:DEXC:AFIL:CAT?
queries the available files with extension *.txt.
Response: 'list1,list2'
the ASCII files list1.txt and list2.txt are available.

Usage: Query only

[[:SOURce<hw>]:LIST:DEXChange:AFILe:EXTension <Extension>

Determines the extension of the ASCII file for import or export, or to query existing files.

Parameters:

<Extension> TXT | CSV
*RST: TXT

Example:

```
MMEM:CDIR '/var/import'
```

selects the directory for the ASCII files with frequency and level value pairs.

```
LIST:DEXC:AFIL:EXT TXT
```

selects ASCII files with the extension *.txt for the query.

```
LIST:DEXC:AFIL:CAT?
```

queries the available files with extension *.txt.

```
Response: 'list1,list2'
```

the ASCII files list1.txt and list2.txt exist.

Manual operation: See "[Extension - List Mode](#)" on page 194

[[:SOURce<hw>]:LIST:DEXChange:AFILe:SELEct <Filename>

Selects the ASCII file to be imported or exported.

Parameters:

<Filename> <ascii_file_name>

Example:

```
LIST:DEXC:MODE IMP
```

determines that ASCII files with frequency and level value pairs are imported into list mode lists.

```
LIST:DEXC:AFIL:EXT TXT
```

determines the extension *.txt for the query.

```
LIST:DEXC:AFIL:CAT?
```

queries the available files with extension *.txt.

```
Response: 'list1,list2'
```

the ASCII files list1.txt and list2.txt exist.

```
LIST:DEXC:AFIL:SEL '/var/list.csv'
```

selects list.csv for import.

```
LIST:DEXC:SEL '/var/list_imp'
```

determines the destination file list_imp.

```
LIST:DEXC:EXEC
```

imports the ASCII file data into the list file.

Manual operation: See "[Select ASCII Source / Destination - List Mode](#)" on page 194

[:SOURce<hw>] :LIST:DEXChange:AFILe:SEParator:COLumn <Column>

Selects the separator between the frequency and level column of the ASCII table.

Parameters:

<Column> TABulator | SEMicolon | COMMa | SPACe
*RST: COMMa

Example:

```
LIST:DEXC:MODE EXP
selects that the list is exported into an ASCII file.
LIST:DEXC:AFIL:SEL '/var/list.csv'
determines ASCII file list.csv as destination for the list mode list
data.
LIST:DEXC:AFIL:SEP:COL TAB
defines a tabulator to separate the frequency and level values
pairs.
LIST:DEXC:AFIL:SEP:DEC DOT
selects the decimal separator dot.
LIST:DEXC:SEL '/var/list_imp'
determines the source file list_imp for export into the ASCII file
list.csv.
LIST:DEXC:EXEC
exports the list file data into the ASCII file.
```

Manual operation: See "[Column Separator- List Mode](#)" on page 194

[:SOURce<hw>] :LIST:DEXChange:AFILe:SEParator:DECimal <Decimal>

Sets the decimal separator used in the ASCII data between '.' (decimal point) and ',' (comma) with floating-point numerals.

Parameters:

<Decimal> DOT | COMMa
*RST: DOT

Example:

```
see [ :SOURce<hw> ] :LIST:DEXChange:AFILe:
SEParator:COLumn on page 363
```

Manual operation: See "[Decimal Point - List Mode](#)" on page 194

[:SOURce<hw>] :LIST:DEXChange:EXECute

Executes the import or export of the selected list file, according to the previously set transfer direction with command [:SOURce<hw>] :LIST:DEXChange:MODE.

Example: LIST:DEXC:MODE IMP
determines that ASCII files with frequency and level value pairs are imported into list mode lists.
LIST:DEXC:AFIL:SEL '/var/list.csv'
selects the ASCII file `list.csv` for import.
LIST:DEXC:SEL '/var/list_imp'
determines the destination file `list_imp`.
LIST:DEXC:EXEC
imports the ASCII file data into the list mode file.

Usage: Event

Manual operation: See "[Import / Export - List Mode](#)" on page 195

[[:SOURce<hw>]:LIST:DEXChange:MODE <Mode>

Selects if list mode lists should be imported or exported. Depending on the selection here, the file select command defines either the source or the destination for list mode lists and ASCII files.

Parameters:

<Mode> IMPort | EXPort
*RST: IMPort

Example: LIST:DEXC:MODE IMP
selects that ASCII files with frequency and level value pairs are imported and transferred into list mode lists.
LIST:DEXC:AFIL:SEL '/var/list.csv'
selects that ASCII file `list.csv` is imported.
LIST:DEXC:SEL '/var/list_imp'
selects that the ASCII file `list.csv` is imported into list mode list `list_imp`.

Manual operation: See "[Mode - List Mode](#)" on page 194

[[:SOURce<hw>]:LIST:DEXChange:SElect <Filename>

Selects the list mode list to be imported or exported.

The list mode files are stored with the fixed file extensions `*.lsw` in a directory of the user's choice. The directory applicable to the commands is defined with the command `MMEMory:CDIR`. A path can also be specified in command `SOUR:LIST:DEXC:SEL`, in which case the files are stored or loaded in the specified directory.

Parameters:

<Filename> <list_name>

Example: LIST:DEXC:MODE IMP
 selects that ASCII files with frequency and level value pairs are imported and transferred into list mode lists.
 LIST:DEXC:AFIL:SEL '/var/list.csv'
 selects that ASCII file list.csv is imported.
 LIST:DEXC:SEL '/var/list_imp'
 selects that the ASCII file list.csv is imported into list mode list list_imp.

Manual operation: See "[Select Destination / Source - List Mode](#)" on page 195

[[:SOURce<hw>]:LIST:DWELI <Dwell>

Sets the dwell time. The R&S SMB generates the signal with the frequency / power value pairs of each list entry for that particular period.

Parameters:

<Dwell> float
 Range: 7E-4 to 100
 Increment: 1E-4
 *RST: 15E-3

Example: LIST:DWEL 15
 each setting in the list is retained for 15 ms.

Manual operation: See "[Dwell Time - List Mode](#)" on page 190

[[:SOURce<hw>]:LIST:FREE?

Queries on the free storage space for list mode lists.

Return values:

<Free> integer
 Range: 0 to INT_MAX
 *RST: 0

Example: LIST:FREE?

Usage: Query only

Response: 2147483647;1

[[:SOURce<hw>]:LIST:FREQuency <Frequency>

Fills the FREQuency column of the selected list with data.

*RST does not affect data lists.

Parameters:

<Frequency>

<Frequency#1>{, <Frequency#2>, ...} | block data

The data can be given either as a list of numbers (list can be of any length and list entries must be separated by commas) or as binary block data. When block data is transferred, 8 bytes are always interpreted as a floating-point number with double accuracy (see :FORMat [:DATA] on page 294).

Range: 300 kHz to RFmax

Example:

LIST:SEL '/var/list3'

selects list3 for editing. The R&S SMB generates a new file automatically, if it does not exist yet.

SOUR:LIST:FREQ 1.4GHz, 1.3GHz, 1.2GHz, ...

specifies the frequency values in list3. If the list already contains data, it is overwritten.

Manual operation: See ["Edit List Mode Data... - List Mode"](#) on page 192**[[:SOURce<hw>]:LIST:FREQuency:POINts?**

The command queries the length (in points) of the FREQuency component of the selected list.

Return values:

<Points>

integer

Range: 0 to INT_MAX

*RST: 0

Example:

LIST:SEL '/var/list3'

selects list3 for editing. The R&S SMB creates a new file automatically, if it does not exist yet.

LIST:FREQ:POIN?

queries the number of frequency values in the list

Response: 327

Usage:

Query only

[[:SOURce<hw>]:LIST:INDEX <Index>

Sets the list index in step mode (LIST:MODE STEP).

After the trigger signal the frequency and level settings of the selected index are processed in List mode.

Parameters:

<Index>

integer

*RST: 0

Example:

```
LIST:SEL '/var/list3'
```

selects list3 for use in List mode.

```
FREQ:MODE LIST
```

activates List mode. List3 is processed.

```
LIST:MODE STEP
```

selects manual, step-by-step processing of the list.

```
LIST:IND 5
```

the frequency/level value pair with index 5 is executed.

```
TRIG:LIST:SOUR SING
```

selects triggering by means of the single trigger. The list is executed once.

```
SOUR:LIST:TRIG:EXEC
```

triggers the processing of the selected list.

Manual operation: See "[Current Index - List Mode](#)" on page 191

[[:SOURce<hw>]:LIST:INDEX:START <Start>

Sets the start index of the index range which defines a subgroup of frequency/level value pairs in the current list. Only the values in the set index range (:LIST:INDEX:START ... :LIST:INDEX:STOP) are processed in List mode.

Parameters:

<Start> integer
 Range: 0 to list length
 *RST: 0

Example:

```
LIST:SEL '/var/list3'
```

selects list3 for use in List mode.

```
LIST:IND:STAR 25
```

sets 25 as start index of the index range.

```
LIST:IND:STOP 49
```

sets 49 as stop index of the index range.

```
FREQ:MODE LIST
```

activates List mode. The frequency/level value pairs from index 25 to index 49 in list3 are processed. All other entries of the list are ignored.

Manual operation: See "[List Range In - List Mode](#)" on page 193

[[:SOURce<hw>]:LIST:INDEX:STOP <Stop>

Sets the stop index of the index range which defines a subgroup of frequency/level value pairs in the current list. Only the values in the set index range (:LIST:INDEX:START ... :LIST:INDEX:STOP) are processed in list mode.

Parameters:

<Stop> integer
 Range: 0 to list length
 *RST: 0

Example: see `[:SOURce<hw>] :LIST:INDEX:START` on page 367

Manual operation: See "[List Range In - List Mode](#)" on page 193

`[:SOURce<hw>] :LIST:LEARn`

Learns the selected list to determine the hardware setting for all list entries. The results are saved with the list. When the list is activated the first time, these settings are calculated automatically.

Example: `LIST:SEL '/var/list3'`
selects list file. The file is created if it does not yet exist.
`LIST:LEAR`
starts learning of the hardware setting for `list3` and stores the setting.

Usage: Event

Manual operation: See "[Learn List Mode Data... - List Mode](#)" on page 191

`[:SOURce<hw>] :LIST:MODE <Mode>`

Selects how the list is to be processed (similar to `SOURce:SWEep:MODE`).

Parameters:

<Mode> AUTO | STEP

AUTO

Each trigger event triggers a complete list cycle. Possible trigger settings for `:LIST:TRIGger:SOURce` are `AUTO`, `SINGLE` and `EXT`.

STEP

Each trigger event triggers only one step in the list processing cycle. The list is processed in ascending order.

*RST: AUTO

Example: `LIST:MODE STEP`
selects step-by-step processing of the list.

Manual operation: See "[Mode - List Mode](#)" on page 189

`[:SOURce<hw>] :LIST:POWer <Power>`

Fills the `Level` part of the selected list with data.

*RST does not affect data lists.

Parameters:

<Power> <Power#1>{, <Power#2>, ...} | block data

The data can be given either as a list of numbers (list can be of any length and list entries must be separated by commas) or as binary block data. When block data is transferred, 8 bytes are always interpreted as a floating-point number with double accuracy (see [:FORMat \[:DATA\]](#) on page 294).

Range: Minimum level to Maximum level

Default unit: dBm

Example:

```
LIST:SEL '/var/list3'
```

selects `list3` for editing. The R&S SMB generates a new file automatically, if it does not exist yet.

```
LIST:POW 0dBm, 2dBm, 2dBm, 3dBm, ..
```

specifies the level values in `list3`. The number of level values must correspond to the number of frequency values. The previous data is overwritten.

Manual operation: See ["Edit List Mode Data... - List Mode"](#) on page 192

[[:SOURce<hw>]:LIST:POWER:POINTS?

Queries the length (in points) of the LEVEL part of the selected list.

Return values:

<Points> integer

Range: 0 to INT_MAX

*RST: 0

Example:

```
LIST:SEL '/var/list3'
```

selects `list3` for editing. The R&S SMB generates a new file automatically, if it does not exist yet.

```
LIST:POW:POIN?
```

queries the number of levels in the list file

Response: 327

Usage:

Query only

[[:SOURce<hw>]:LIST:RESet

Resets the list to the starting point.

Example:

```
LIST:RES
```

resets the list to the starting point.

Usage:

Event

Manual operation: See ["Reset - List Mode"](#) on page 190

[SOURce<hw>]:LIST:SElect <Filename>

Selects the specified list. If a new list is to be created, the name can be entered here. The list is created if it does not yet exist. The list selected here is available for the further processing steps (editing) and is used in the instrument when the list mode is activated.

The files are stored with the fixed file extensions *.lsw in a directory of the user's choice. The directory applicable to the command is defined with the command `MMEMory:CDIR`. A path can also be specified in which case the list mode file in the specified directory is selected.

*RST does not affect data lists.

Parameters:

<Filename> '<list name>'

Example:

```
LIST:SEL '/var/list3'
selects list3 for editing.
```

Manual operation: See ["List Mode Data... - List Mode"](#) on page 191

[SOURce<hw>]:LIST:TRIGger:EXECute

Starts the processing of a list in list mode. It corresponds to the manual-control command "Execute Single."

Example:

```
SOUR:LIST:TRIG:EXEC
triggers the processing of the selected list.
```

Usage:

Event

Manual operation: See ["Execute Single - List Mode"](#) on page 190

[SOURce<hw>]:LIST:TRIGger:SOURce <Source>

Selects the trigger source processing lists.

The names of the parameters correspond to those under sweep mode. SCPI uses other names for the parameters; these names are also accepted by the instrument. The SCPI names should be used if compatibility is an important consideration. An overview of the various names is given in the following table:

R&S name	SCPI name	Command under manual control
AUTO	IMMediate	MODE AUTO
SINGLE	BUS	MODE SINGLE or STEP
EXTernal	EXTernal	MODE EXT TRIG SINGLE or EXT TRIG STEP

Parameters:

<Source> AUTO | IMMEDIATE | SINGLE | BUS | EXTERNAL

AUTO|IMMEDIATE

The trigger is free-running, i.e. the trigger condition is fulfilled continuously. The selected list in List mode is restarted as soon as it is finished.

SINGLE|BUS

The list is triggered by the GPIB commands `[:SOURce<hw>] : LIST:TRIGger:EXECute`. The list is executed once.

EXTERNAL

The list is triggered externally via the INST TRIG connector. The list is executed once.

*RST: AUTO

Example:

LIST:TRIG:SOUR EXT
selects triggering by means of the external trigger.

Manual operation: See "Mode - List Mode" on page 189

7.13.8 SOURce:MODulation Subsystem

This subsystem contains the command for switching on/off all modulations.

`[:SOURce<hw>] : MODulation [: ALL] [: STATe] <State>`

Activates/deactivates the modulations.

The command `SOUR:MOD:ALL:STAT OFF` switches all modulations off. A subsequent command `SOUR:MOD:ALL:STAT ON` restores the status that was active before the last switch-off. "MOD OFF" is displayed in the info line of the header next to the "Level" field.

Parameters:

<State> 0 | 1 | OFF | ON

*RST: 1

Example:

MOD:STAT OFF
switches off all modulations.

Manual operation: See "MOD ON/OFF" on page 197

7.13.9 SOURce:PGEN Subsystem

This subsystem contains the commands for setting the pulse generator.

`[:SOURce<hw>] : PGENerator:STATe..... 372`

[:SOURce<hw>]:PGENerator:STATe <State>

Activates/deactivates the output of the video/sync signal at the PULSE VIDEO connector at the rear of the instrument.

The signal output and the pulse generator are automatically switched on with activation of pulse modulation if pulse generator is selected as modulation source. The signal output can be switched off subsequently.

Parameters:

<State> 0 | 1 | OFF | ON
*RST: 0

Example:

PULM:SOUR INT
selects the internal pulse generator as source for pulse modulation
PULM:STAT ON
activates pulse modulation. The pulse generator and the output of the signals at the PULSE VIDEO connector are automatically activated in addition.
PGEN:STAT OFF
deactivates the output of the pulse signal by the pulse generator at the PULSE VIDEO connector. The pulse modulation of the RF carrier must be activated with command `SOURce:PULM:STATe`.

Manual operation: See "[Video Sync Signal State - Pulse Generator](#)" on page 227

7.13.10 SOURce:PHASe Subsystem

This subsystem contains the commands for adjusting the phase of the RF output signal relative to a reference signal of the same frequency.

[:SOURce<hw>]:PHASe	372
[:SOURce<hw>]:PHASe:REFerence	373

[:SOURce<hw>]:PHASe <Phase>

Sets the phase variation relative to the current phase. The variation is specified in RADians.

Parameters:

<Phase> float
Range: -720 to 720
Increment: 0.1
*RST: 0

Example:

PHAS 0.1 RAD
changes the phase by 0.1 RAD relative to the current phase.
PHAS:REF
adopts the set phase as the current phase.

Manual operation: See "[Delta Phase](#)" on page 141

[:SOURce<hw>]:PHASe:REFerence

Adopts the phase set with `SOURce:PHASe:ADJust` as the current phase.

Example: `PHAS 0.1RAD`
 changes the phase by 0.1 RAD relative to the current phase.
 `PHAS:REF`
 adopts the set phase as the current phase.

Usage: Event

Manual operation: See "[Reset Delta Phase Display](#)" on page 141

7.13.11 SOURce:PM Subsystem

The PM subsystem contains the commands for checking the phase modulation. The settings for the internal modulation source (LF generator) are made in the [SOURce:LFOuTput](#) subsystem.

For information on the required options, see [Chapter 5.4.4, "Phase Modulation \(PhiM\)"](#), on page 206.

[:SOURce<hw>]:PM[:DEViation]	373
[:SOURce<hw>]:PM:EXTernal:COUPling	373
[:SOURce<hw>]:PM:EXTernal:DEViation	374
[:SOURce<hw>]:PM:INTernal:DEViation	374
[:SOURce<hw>]:PM:MODE	375
[:SOURce<hw>]:PM:SENSitivity?	375
[:SOURce<hw>]:PM:SOURce	375
[:SOURce<hw>]:PM:STATe	376

[:SOURce<hw>]:PM[:DEViation] <Deviation>

Sets the deviation of the phase modulation signals in RAD. The maximum deviation depends on the set RF frequency and the selected modulation mode (see data sheet).

Parameters:

<Deviation> float
 Range: see data sheet
 Increment: 1E-6

Example: `PM 2`
 sets 2 RAD deviation to the phase modulation signal.

Manual operation: See "[φM Deviation](#)" on page 207

[:SOURce<hw>]:PM:EXTernal:COUPling <Coupling>

Selects the coupling mode for the external phase modulation signal.

Parameters:

<Coupling> AC | DC

AC

Uses only the AC signal component of the modulation signal.

DC

Uses the modulation signal as it is, with AC and DC.

*RST: AC

Example:

PM:EXT:COUP AC

selects the coupling mode AC for the external phase modulation signal.

Manual operation: See "[PhiM Ext Coupling](#)" on page 208**[:SOURce<hw>]:PM:EXTernal:DEViation <Deviation>**

Sets the modulation deviation of the external phase modulation signal in RAD. The maximum value depends on the set RF frequency and the selected modulation mode (see data sheet).

The sum of the deviations of all active frequency modulation signals may not exceed the total value set with command `[:SOURce<hw>]:PM:EXTernal:DEViation`.**Parameters:**

<Deviation> float

Range: 0 to 20

*RST: 1

Example:

PM 5

sets 5 RAD deviation for the external phase modulation signal.

Manual operation: See "[φM Deviation](#)" on page 207**[:SOURce<hw>]:PM:INTernal:DEViation <Deviation>**

Sets the deviation of the internal phase modulation signal in RAD.

The sum of the deviations of all active frequency modulation signals may not exceed the total value set with command `[:SOURce<hw>]:PM[:DEViation]`.**Parameters:**

<Deviation> float

Range: see data sheet

Increment: 1E-6

*RST: 1

Example:

PM:INT1:DEV 3RAD

sets 3 RAD deviation for the internal phase modulation signal.

Manual operation: See "[φM Deviation](#)" on page 207

[[:SOURce<hw>]:PM:MODE <Mode>

Selects the mode for the phase modulation.

Parameters:

<Mode> HDEVIation | NORMal | LNOise

HDEVIation

Provides full setting range of PhiM deviation. The range of modulation frequency is limited (see data sheet). Recommended for low modulation frequencies and/or high PhiM deviation.

NORMal

Provides full setting range of modulation bandwidth and PhiM deviation. Recommended for high modulation frequencies.

LNOise

Provides modulation with phase noise and spurious characteristics close to CW mode. The range for modulation bandwidth and PhiM deviation is limited (see data sheet)

*RST: HBANdwidth

Example:

```
PM:MODE LNO
```

selects Low Noise mode for external phase modulation.

Manual operation: See "[ϕM Mode](#)" on page 207

[[:SOURce<hw>]:PM:SENSitivity?

Queries the input sensitivity of the externally applied signal for phase modulation. The returned value reports the sensitivity in RAD/V. It is assigned to the voltage value for full modulation of the input.

Return values:

<Sensitivity> float

Example:

```
PM:DEV 1
```

sets a modulation deviation of 1RAD.

```
PM:SENS?
```

queries the input sensitivity at the external modulation input.

```
Response: 1
```

since the voltage value for full modulation is 1V, the resulting sensitivity is precisely 1RAD/V.

Usage:

Query only

Manual operation: See "[ϕM Sensitivity](#)" on page 208

[[:SOURce<hw>]:PM:SOURce <Source>

Selects the modulation signal source for phase modulation.

You can use both, the internal and an external modulation signal at a time.

Parameters:

<Source> INTernal | EXTernal | INT,EXT

INTernal

Uses the internally generated signal for modulation. To configure the LF signal, use the commands of the [SOURce:LFOutput Subsystem](#) subsystem.

EXTernal

Uses an externally applied modulation signal.

INT,EXT

Uses both, the internal and external modulation signals.

*RST: INT

Example:

PM:SOUR INT
selects the internal modulation source.

Manual operation: See "[ϕM Source](#)" on page 207

[:SOURce<hw>]:PM:STATe <State>

Activates phase modulation.

Note: Activation of PM deactivates frequency modulation (FM).

Parameters:

<State> 0 | 1 | OFF | ON

*RST: 0

Example:

PM:STAT ON
activates PM.

Manual operation: See "[State](#)" on page 207

7.13.12 SOURce:POWer Subsystem

This subsystem contains the commands for setting the output level, level control and level correction of the RF signal.

Other units can also be used instead of dBm:

- by entering the unit directly after the numerical value (example :POW 0.5V)
- by changing the DEFault unit in the UNIT system (see the command [:UNIT:POWer](#)).

[:SOURce<hw>]:POWer:ALC:OMODE	377
[:SOURce<hw>]:POWer:ALC:SONCe	377
[:SOURce<hw>]:POWer:ALC[:STATe]	377
[:SOURce<hw>]:POWer:ATTenuation:RFOff:MODE	378
[:SOURce<hw>]:POWer:EMF:STATe	378
[:SOURce<hw>]:POWer[:LEVel][:IMMediate][:AMPLitude]	379
[:SOURce<hw>]:POWer[:LEVel][:IMMediate]:OFFSet	379
[:SOURce<hw>]:POWer[:LEVel][:IMMediate]:RCL	380
[:SOURce<hw>]:POWer:LIMit[:AMPLitude]	380

<code>[:SOURce]:POWer:WIGNore</code>	381
<code>[:SOURce<hw>]:POWer:LMODe</code>	381
<code>[:SOURce<hw>]:POWer:MANual</code>	382
<code>[:SOURce<hw>]:POWer:MODE</code>	382
<code>[:SOURce<hw>]:POWer:POWer</code>	383
<code>[:SOURce<hw>]:POWer:SPC:CRANge</code>	383
<code>[:SOURce<hw>]:POWer:SPC:DELAy</code>	384
<code>[:SOURce<hw>]:POWer:SPC:PEAK</code>	384
<code>[:SOURce<hw>]:POWer:SPC:SELEct</code>	384
<code>[:SOURce<hw>]:POWer:SPC:STATe</code>	385
<code>[:SOURce<hw>]:POWer:SPC:TARGet</code>	385
<code>[:SOURce<hw>]:POWer:STARt</code>	385
<code>[:SOURce<hw>]:POWer:STEP[:INCRement]</code>	386
<code>[:SOURce<hw>]:POWer:STEP:MODE</code>	386
<code>[:SOURce<hw>]:POWer:STOP</code>	387

`[:SOURce<hw>]:POWer:ALC:OMODe <OffMode>`

The command sets the level control mode which becomes active when automatic level control is deactivated (ALC Off).

Parameters:

<OffMode> SHOLd

SHOLd

Level control is activated briefly if the level or frequency changes ("ALC Off Sample & Hold").

*RST: SHOLd

Example:

`POW:ALC OFF`

deactivates automatic level control for RF output A.

`POW:ALC:OMOD SHOL`

level control is briefly activated if the frequency or level changes.

`[:SOURce<hw>]:POWer:ALC:SONCe`

Temporarily activates level control for correction purposes.

Example:

`POW:ALC OFF`

deactivates automatic level control for RF output A.

`POW:ALC:SONC`

level control is performed once only.

Usage:

Event

Manual operation: See "[Search Once - ALC](#)" on page 153

`[:SOURce<hw>]:POWer:ALC[:STATe] <State>`

Activates/deactivates automatic level control.

Parameters:

<State>

ON | OFF | AUTO

ON

Internal level control is permanently activated.

OFF

Internal level control is deactivated; Sample & Hold mode is activated.

AUTO

Internal level control is activated/deactivated automatically depending on the operating state.

*RST: AUTO

Example:

POW:ALC ON

activates automatic level control for RF output A.

Manual operation: See "State - ALC" on page 153**[:SOURce<hw>]:POWer:ATTenuation:RFOff:MODE <Mode>**

Selects the attenuator mode, when the RF signal is switched off.

The setting of the RF OFF mode is not affected by an instrument preset (PRESET key), *RST and the "Save/Recall" function. This parameter is influenced only by the [Factory Preset](#).

Parameters:

<Mode>

UNCHanged | FATTenuation

UNCHanged

Freezes the setting of the attenuator when RF is switched off.

The attenuator is only activated when RF is switched on.

This setting recommended if a constant VSWR (**V**oltage **S**tanding **W**ave **R**atio) is required.

Furthermore, on instruments equipped with a mechanical attenuator, it provides fast and wear-free operation.

FATTenuation

Sets attenuation to maximum when the RF signal is switched off.

This setting is recommended for applications that require a high level of noise suppression.

*RST: depends on instrument hardware

Example:

SOUR:POW:ATT:RFOFF:MODE FATT

sets the RF OFF attenuator to maximum.

Manual operation: See "RF OFF Mode" on page 150**[:SOURce<hw>]:POWer:EMF:STATe <State>**

Displays the signal level as voltage of the EMF. The displayed value represents the voltage over a 50 Ohm load.

Parameters:

<State> 0 | 1 | OFF | ON
 *RST: 0

Example:

POW:EMF:STAT 1
 activates voltage level display.

Manual operation: See "Display Level as Voltage of EMF - RF Level" on page 151

[:SOURce<hw>]:POWER[:LEVel][:IMMediate][:AMPLitude] <Amplitude>

Sets the RF level applied to the DUT.

Notes:

If specified, a level offset `[:SOURce<hw>]:POWER[:LEVel][:IMMediate]:OFFSet` is included according to the formula:

Minimum level + OFFSet ... Maximum level + OFFSet

In addition to numerical values, you can increase or decrease the values step by step with the UP and DOWN according to the step width defined with `[:SOURce<hw>]:POWER:STEP[:INCRement]`.

The RF output is activated with `:OUTPut<hw>[:STATe]` on page 314 (RF ON / RF OFF).

Parameters:

<Amplitude> Minimum level ... Maximum level
 Determines the RF output level.
 Range: Minimum level to Maximum level
 *RST: -30

Example:

The keywords of this command are largely optional. Therefore, both the long and short form of the command are shown.
`SOUR:POW:LEV:IMM:AMPL 15`
 or
`:POW 15`
 sets the RF level at output A to 15 dBm.

Manual operation: See "RF Level" on page 146

[:SOURce<hw>]:POWER[:LEVel][:IMMediate]:OFFSet <Offset>

Note: The level offset is also effective for level sweeps!

Specifies the constant level offset of a downstream attenuator/amplifier. If a level offset is entered, the level entered with `:POWER` no longer corresponds to the RF output level.

The following correlation applies:

`POWER = RF output level + POWER:OFFSet.`

Entering a level offset does not change the RF output level, but rather the query value of :POWER.

For more information, see ["RF level vs. RF output level"](#) on page 145.

Only dB is permitted as the unit here. The linear units (V, W, etc.) are not permitted.

The keywords of this command are largely optional. Therefore, both the long and short form of the command are shown in the example.

Parameters:

<Offset> float
 Range: -100 to 100
 Increment: 0.01
 *RST: 0

Example:

SOURce:POWer:LEVel:IMMediate:OFFSet -10
 or
 POW:OFFS 10
 sets the RF level offset to 10 dB

Manual operation: See ["Offset \(Level\)"](#) on page 148

[[:SOURce<hw>]:POWer[:LEVel][:IMMediate]:RCL <Rcl>

Determines whether the RF level is retained or taken from a loaded instrument configuration, when you recall instrument settings with the command *RCL.

Parameters:

<Rcl> INCLUDE | EXCLUDE
INCLUDE
 Takes the level value of the loaded settings.
EXCLUDE
 Retains the current level when an instrument configuration is loaded.
 *RST: INCLUDE

Example:

POW:RCL INCL
 takes the level value from an instrument configuration loaded with command *RCL.

Manual operation: See ["Exclude Level"](#) on page 129

[[:SOURce<hw>]:POWer:LIMit[:AMPLitude] <Amplitude>

Limits the maximum RF output level in CW and SWEEP mode. It does not influence the "Level" display or the response to the POW? query command.

The value is not affected by an instrument preset (PRESET key), *RST and the Save/Recall function. This parameter is influenced only by the factory preset (SYST:FPR) and its factory value is equal to the upper limit.

Parameters:

<Amplitude> float

Minimum level ... Maximum level

The value range for the level setting varies according to the instrument model.

The values are given in the data sheet.

Increment: 0.01

*RST: 30

Example:

SOURce:POWer:LIMit:AMPLitude 10

or

:POW:LIM 10

limits the RF level to maximum +10 dBm.

Manual operation: See "[Limit - RF Level](#)" on page 147**[:SOURce]:POWer:WIGNore <State>**

Ignores level range warnings.

Parameters:

<State> 0 | 1 | OFF | ON

*RST: 0

Example:

POW:WIGN ON

suppresses the level range warnings.

Manual operation: See "[Ignore Level Range Warnings](#)" on page 148**[:SOURce<hw>]:POWer:LMODe <LevMode>**

Sets the RF level mode.

Parameters:

<LevMode> NORMal | LOWNoise | LOWDistortion

NORMal

The RF signal is output in the standard values of the instrument.

LOWNoise

A very low noise sinewave signal is output.

LOWDistortion

A very pure sinewave signal is output.

*RST: NORMal

Example:

POW:LMODe LOWD

sets the LOWDistortion mode. The instrument reduces distortions of the RF signal to a minimum.

Manual operation: See "[RF Mode](#)" on page 147

[:SOURce<hw>]:POWer:MANual <Manual>

In Sweep mode (:SOUR:POW:MODE SWE) the command sets the level for the next sweep step in the Step sweep mode (:SOUR:SWE:POW:MODE MAN). Here only level values between the settings [:SOUR]:POW:STAR and [:SOUR]:POW:STOP are permitted. Each sweep step is triggered by a separate :SOUR:POW:MAN command.

As with the "Level" value entered in the "RF Level" menu, the OFFSet value is also taken into consideration with this command.

The specified value range is therefore only effective if :SOURce:POWer:OFFSet is set to 0. The value range for other OFFset values can be calculated using the following formula:

Minimum level + OFFSet ... Maximum level + OFFSet

Parameters:

<Manual>

float

Minimum level ... Maximum level

The value range for the level setting varies according to the instrument model

The values are given in the data sheet.

Increment: 0.01

*RST: -30

Example:

POW:SWE:MODE MAN

sets the Step sweep mode for RF output A.

POW:MAN -5 dBm

sets an RF level of -5 dBm for the next setting in the Step sweep mode for RF output A.

POW:MODE SWE

sets the Level Sweep mode for RF output A.

POW:MAN -5.5 dBm

triggers the next sweep step with a level of -5.5 dBm.

Manual operation: See "[Current Level - Level Sweep](#)" on page 186

[:SOURce<hw>]:POWer:MODE <Mode>

Sets the instrument operating mode and therefore also the commands used to set the output level.

Parameters:

<Mode> CW | FIXed | SWEep

CW|FIXed

Operates at a constant level.

CW and FIXed are synonyms. To set the output level value, use the command `[:SOURce<hw>] :POWer [:LEVel] [:IMMediate] [:AMPLitude]`.

SWEep

Operates in power sweep mode.

Set the range and current level with the commands `[:SOURce<hw>] :POWer:STARt`, `[:SOURce<hw>] :POWer:STOP` and `[:SOURce<hw>] :POWer:MANual`.

*RST: CW

Example:

```
POW:MODE SWEep
selects the SWEep mode using the
POW:STAR; POW:STOP; POW:MAN settings.
```

Manual operation: See "State - Level Sweep" on page 182

[:SOURce<hw>] :POWer:POWer <Power>

Sets the RF level of the RF output connector.

The level entered with this command corresponds to the level at the RF output, i.e. any offset entry is not taken into consideration.

Note: The SCPI command `[:SOURce<hw>] :POWer [:LEVel] [:IMMediate] [:AMPLitude]` sets the level of the "Level" display, i.e. the level containing offset.

Parameters:

<Power> Minimum level ... Maximum level

The value range for the level setting varies according to the instrument model.

The values are given in the data sheet.

Increment: 0.01

*RST: -30

Example:

```
SOUR:POW:POW 15
sets the RF level at output to 15 dBm.
```

Manual operation: See "Amplitude" on page 147

[:SOURce<hw>] :POWer:SPC:CRANge <PowCntrlCRange>

Defines the capture range of the power control system.

Within the range:

Target Level +/- Catch Range

the power control locks and tries to achieve the target level. Readings outside the range are not considered.

Parameters:

<PowCntrlCRange> float
 Range: 0 to 50
 Increment: 0.01
 *RST: 30
 Default unit: dB

Example:

POW:SPC:CRAN 15
 sets the capture range to +/- 15 dB.

Manual operation: See ["Catch Range +/-"](#) on page 157

[[:SOURce<hw>]:POWER:SPC:DELay <PowCntrlDelay>

Defines a waiting period between the level adjustment of the generator and the next measurement of the power sensor.

Parameters:

<PowCntrlDelay> integer
 Range: 0 to 1000
 *RST: 0

Example:

:POW:SPC:DEL 2 ms
 the sensor starts the next reading 2 ms after the level adjustment.

Manual operation: See ["Delay Time"](#) on page 157

[[:SOURce<hw>]:POWER:SPC:PEAK <PowCntrlPeak>

Activates power control by means of the peak power values, provided the power sensor supports this function.

Parameters:

<PowCntrlPeak> 0 | 1 | OFF | ON
 *RST: 0

Example:

POW:SPC:PEAK ON
 uses the measured peak power for power control.

Manual operation: See ["Use Peak Power"](#) on page 157

[[:SOURce<hw>]:POWER:SPC:SElect <PowCntrlSelect>

Defines the currently selected sensor to be used for power control.

Parameters:

<PowCntrlSelect> SENS1 | SENS2 | SENS3 | SENS4
 *RST: SENS1

Example: `POW:SPC:SEL SENS2`
selects the sensor connected to a second USB interface for power control.

Manual operation: See "[Sensor](#)" on page 156

[:SOURce<hw>]:POWER:SPC:STATE <PowCntrlState>

Activates power control using the selected sensor. The control loop periodically adjusts the generator output. After switching off, the running loop is completed.

Parameters:

<PowCntrlState> 0 | 1 | OFF | ON
*RST: 0

Example: `POW:SPC:STAT ON`
activates power control.

Manual operation: See "[State](#)" on page 156

[:SOURce<hw>]:POWER:SPC:TARGet <PowCntrlTarget>

Sets the nominal level expected at the input of the sensor. To define the unit of the power value, use command `:SENSe<ch>:UNIT [:POWER]` on page 324.

Parameters:

<PowCntrlTarget> float
Range: -50 to 30
Increment: 0.01
*RST: -10

Example: `SENS:UNIT dBm`
selects unit dBm for setting the target level value.
`POW:SPC:TARG -10`
sets -10 dBm target level.

Manual operation: See "[Target Level](#)" on page 157

[:SOURce<hw>]:POWER:START <Start>

Sets the start level for the RF sweep.

Note: You can select any level within the setting range. The range is defined by this start value and the `[:SOURce<hw>]:POWER:STOP` value.

A defined offset (`[:SOURce<hw>]:POWER[:LEVEL] [:IMMEDIATE]:OFFSet`) affects the level values according to the formula:

Minimum level + OFFSet ... Maximum level + OFFSet

Parameters:

<Start> float
 Determines the first level value of the sweep setting range.
 Range: full specified level range
 Increment: see the data sheet: Level sweep > Step size setting resolution
 *RST: -30

Example:

POW:STAR -20 dBm
 sets the start level for the level sweep to -15 dBm for RF output A.

Manual operation: See "[Start Level - Level Sweep](#)" on page 185

[:SOURce<hw>]:POWER:STEP[:INCRement] <Increment>

Sets the step width for [POW:STEP:MODE USER](#).

To adjust the level step by step with this step size, use the `POW:UP` and `POW:DOWN` commands.

Note: This value also applies to the step width of the rotary knob of the instrument and increases or decreases the level accordingly, when you work in user-defined step mode.

Parameters:

<Increment> float
 Range: full specified level range
 Increment: see the data sheet: Level sweep > Step size setting resolution
 *RST: 1

Example:

POW:STEP 2
 sets the step width for entering the RF level to 2 dB.

Manual operation: See "[Variation Step](#)" on page 150

[:SOURce<hw>]:POWER:STEP:MODE <Mode>

Activates (`USER`) or deactivates (`DECimal`) the user-defined step width used when varying the level value with the level values `UP/DOWN`. The command is linked to setting "Variation Active" for manual control, i.e. the command also activates/deactivates the user-defined step width used when varying the level value with the rotary knob.

Parameters:

<Mode> DECimal | USER
 *RST: DECimal

Example: `POW:STEP 2`
 sets the step width for the level setting to 2 dB.
`POW:STEP:MODE USER`
 activates this step width for level variation with the rotary knob (manual control) and with level values UP/DOWN (remote control).

Manual operation: See "[Variation Active](#)" on page 150

[:SOURce<hw>]:POWer:STOP <Stop>

Sets the stop level for the RF sweep.

Note: You can select any level within the setting range. The range is defined by the `[:SOURce<hw>]:POWer:START` value and this stop value.

A defined offset (`[:SOURce<hw>]:POWer[:LEVel] [:IMMediate]:OFFSet`) affects the level values according to the formula:

Minimum level + OFFSet ... Maximum level + OFFSet

Parameters:

`<Stop>` float
 Determines the last level value of the sweep setting range.
 Range: full specified level range
 Increment: see the data sheet: Level sweep > Step size setting resolution
 *RST: -10

Example: `POW:STOP 3`
 sets the stop level for the level sweep to 3 dBm for RF output A.

Manual operation: See "[Stop Level - Level Sweep](#)" on page 186

7.13.13 SOURce:PULM Subsystem

This subsystem contains the commands for setting the pulse modulation.

The LF generator is used as the internal modulation source. The pulse frequency of the internal rectangular signal is therefore set in the `SOURce:LFOutput` subsystem.

The external signal is input at the PULSE EXT connector. The connector can be used as trigger input for internal pulse modulation. The polarity and input impedance of the connector can be selected. The pulse modulation signal is output at the PULSE VIDEO connector.

Programming Examples

Example: Performing pulse modulation

This example shows a command sequence to perform pulse modulation.

```

// *****
// Reset the instrument to start from an initial state
// *****
*RST; *CLS

// *****
// Set the RF signal frequency and level
// *****
SOURCE:FREQuency:CW 400000000
SOURCE:POWer:LEVel:IMMediate:AMPLitude -25

// *****
// Configure the pulse modulation settings
// *****
// Select the internal modulation generator
SOURCE:PULM:SOURce INT
// Set trigger mode
SOURCE:PULM:TRIGGer:MODE AUTO
// Select pulse mode
SOURCE:PULM:MODE DOUB

// *****
// Alternatively configure the pulse modulation settings for
// external modulation source
// *****
// Select the external modulation source
SOURCE:PULM:SOURce EXT
// Set the polarity of the externally applied modulation signal.
SOURCE:PULM:POLarity NORMal
// Select the impedance for the external pulse modulation trigger input
SOURCE:PULM:TRIGGer:EXTernal:IMPedance G10K

// *****
// Configure the pulse generator settings
// *****
// Set pulse period
SOURCE:PULM:PERiod 10 us
// Set pulse width
SOURCE:PULM:WIDth 8 us
// Set double pulse width
SOURCE:PULM:DOUBle:WIDTh 0.0000012
// Set double pulse delay
SOURCE:PULM:DOUBle:DELay 0.0000045

// *****
// Activate the signal output
// *****
SOURCE:PGENERator:OUTPut:STATe 1

```

```
SOURce:PULM:STATe 1
OUTPut1:STATe 1
```

Example: Generating a pulse train signal

This example shows a command sequence to create a pulse train signal.



Prior to the selection of the pulse train mode make sure that you have generated and selected a pulse train data list. Otherwise, the instrument generates an error.

```
// *****
// Reset the instrument to start from an initial state
// *****
*RST; *CLS

// *****
// Set the RF signal frequency and level
// *****
SOURce:FREQuency:CW 400000000
SOURce:POWer:LEVel:IMMediate:AMPLitude -25

// *****
// Create a pulse train data list
// *****
// Select the directory
MMEM:CDIR '/var/user/Lists/'
// Create and/or select the pulse train data file
SOURce:PULM:TRain:SEL 'P_FIVE'
// Enter the pulse train data
SOURce:PULM:TRain:ONTime 10ns,30ns,40ns,20ns,10ns
SOURce:PULM:TRain:OFFTime 30ns,40ns,50ns,40ns,30ns
SOURce:PULM:TRain:REPetition 10,1,3,10,6

// *****
// Select pulse train mode
// *****
// Select the internal modulation generator and the pulse mode
SOURce:PULM:SOURce INTernal
SOURce:PULM:MODE PTRain

// *****
// Activate the signal output
// *****
SOURce:PGENERator:OUTPut:STATe 1
SOURce:PULM:STATe 1
OUTPut1:STATe 1
```

[:SOURce<hw>]:PULM:DELay.....	390
[:SOURce<hw>]:PULM:DOUBle:DELay.....	391
[:SOURce<hw>]:PULM:DOUBle:STATe.....	391
[:SOURce<hw>]:PULM:DOUBle:WIDTh.....	391
[:SOURce<hw>]:PULM:MODE.....	391
[:SOURce<hw>]:PULM:OUTPut:SYNC[:STATe].....	392
[:SOURce<hw>]:PULM:PERiod.....	392
[:SOURce<hw>]:PULM:POLarity.....	393
[:SOURce<hw>]:PULM:SOURce.....	393
[:SOURce<hw>]:PULM:STATe.....	394
[:SOURce<hw>]:PULM:TRAIIn:CATalog?.....	394
[:SOURce<hw>]:PULM:TRAIIn:DELete.....	394
[:SOURce<hw>]:PULM:TRAIIn:OFFTime.....	395
[:SOURce<hw>]:PULM:TRAIIn:OFFTime:POINts?.....	395
[:SOURce<hw>]:PULM:TRAIIn:ONTime.....	396
[:SOURce<hw>]:PULM:TRAIIn:ONTime:POINts?.....	396
[:SOURce<hw>]:PULM:TRAIIn:REPetition.....	397
[:SOURce<hw>]:PULM:TRAIIn:REPetition:POINts?.....	397
[:SOURce<hw>]:PULM:TRAIIn:SElect.....	398
[:SOURce<hw>]:PULM:TRIGger:EXTernal:GATE:POLarity.....	398
[:SOURce<hw>]:PULM:TRIGger:EXTernal:IMPedance.....	399
[:SOURce<hw>]:PULM:TRIGger:EXTernal:SLOPe.....	399
[:SOURce<hw>]:PULM:TRIGger:MODE.....	399
[:SOURce]:PULM[:INTernal][:TRAIIn]:TRIGger:IMMediate.....	400
[:SOURce<hw>]:PULM:TRAIIn:DEXChange:AFILe:CATalog?.....	400
[:SOURce<hw>]:PULM:TRAIIn:DEXChange:AFILe:EXTension.....	401
[:SOURce<hw>]:PULM:TRAIIn:DEXChange:AFILe:SElect.....	401
[:SOURce<hw>]:PULM:TRAIIn:DEXChange:AFILe:SEParator:COLumn.....	402
[:SOURce<hw>]:PULM:TRAIIn:DEXChange:AFILe:SEParator:DECimal.....	402
[:SOURce<hw>]:PULM:TRAIIn:DEXChange:EXECute.....	403
[:SOURce<hw>]:PULM:TRAIIn:DEXChange:MODE.....	403
[:SOURce<hw>]:PULM:TRAIIn:DEXChange:SElect.....	404
[:SOURce<hw>]:PULM:WIDTh.....	404

[:SOURce<hw>]:PULM:DELay <Delay>

Sets the pulse delay.

Parameters:

<Delay>	float
	Range: 0 to 100 s
	Increment: 10 ns
	*RST: 10 ns

Example: PULM:DEL 13 us
13 us elapse after a trigger before the first pulse is generated.

Options: R&S R&S SMB-K23 (Pulse Generator)

Manual operation: See "[Pulse Delay - Pulse Generator](#)" on page 228

[:SOURce<hw>]:PULM:DOUBLE:DELay <Delay>

Sets the delay from the start of the first pulse to the start of the second pulse.

Parameters:

<Delay>	float
	Range: 10 ns to 100 s
	Increment: 5 ns
	*RST: 3 us

Example:

PULM:DOUB:DEL 22 us
 22 us elapse between the beginning of the first pulse and the beginning of the second pulse in double-pulse mode.

Options: R&S SMB-K23 (Pulse Generator)**Manual operation:** See "[Double Pulse Delay - Pulse Generator](#)" on page 228

[:SOURce<hw>]:PULM:DOUBLE:STATE <State>

Enables/disables double pulse generation. The two pulses are generated in one pulse period.

Parameters:

<State>	0 1 OFF ON
	*RST: 0

Example:

PULM:DOUB:STAT ON
 double-pulse mode is enabled.

Options: R&S SMB-K23 (Pulse Generator)

[:SOURce<hw>]:PULM:DOUBLE:WIDTH <Width>

Sets the width of the second pulse in case of double pulse generation.

Parameters:

<Width>	float
	Range: 10 ns to 100 s
	Increment: 10 ns
	*RST: 3 us

Example:

PULM:DOUB:WIDT 33 us
 sets a width of 33 us for the second pulse.

Options: R&S SMB-K23 (Pulse Generator)**Manual operation:** See "[Double Pulse Width - Pulse Generator](#)" on page 228

[:SOURce<hw>]:PULM:MODE <Mode>

Sets the mode of the pulse generator.

Parameters:

<Mode> SINGLE | DOUBle | PTRain

SINGle

Enables single pulse generation.

DOUBle

Enables double pulse generation. The two pulses are generated in one pulse period.

PTRain

A user-defined pulse train is generated. The pulse train is defined by value pairs of on and off times that can be entered in a pulse train list.

*RST: SINGLE

Example:

PULM:MODE DOUB
enables double pulse generation.

Options:

R&S SMB-K23 (Pulse Generator), R&S SMB-K27 (Pulse Train)

Manual operation: See "[Pulse Mode - Pulse Generator](#)" on page 227

[[:SOURce<hw>]:PULM:OUTPut:SYNC[:STATe] <Sync>

Configures the signal at the SIGNAL VALID connector.

Parameters:

<Sync> 0 | 1 | OFF | ON

ON

Generates a single pulse at the beginning of a pulse sequence, e.g. to synchronize pulse modulation.

OFF

Returns the validity of the RF signal at the output:

1 (high), while the signal settles.

0 (low), when it is stable (valid).

*RST: OFF

Example:

PULM:OUTP:SYNC ON
uses the signal for synchronizing the pulse modulation.

Manual operation: See "[Use SIGNAL VALID as Pulse Sync](#)" on page 229

[[:SOURce<hw>]:PULM:PERiod <Period>

Sets the period of the generated pulse. The period determines the repetition frequency of the internal signal.

Parameters:

<Period> float

Range: 5 us | 20 ns to 100 s

Increment: 1us | 5 ns

*RST: 10 us

- Example:** PULM:PER 220 us
the pulse period is 220 us.
- Options:** R&S SMB-K23 (Pulse Generator)
- Manual operation:** See "[Pulse Period - Pulse Generator](#)" on page 228

[:SOURce<hw>]:PULM:POLarity <Polarity>

Sets the polarity between modulating and modulated signal. This command is effective only for an external modulation signal.

Parameters:

<Polarity> NORMal | INVerted

NORMal

The RF signal is suppressed during the pulse pause.

INVerted

The RF signal is suppressed during the pulse.

*RST: NORMal

- Example:** PULM:SOUR EXT
selects the external modulation source.

- Example:** PULM:POL INV
selects inverted polarity.

- Options:** R&S SMB-K22 (Pulse Modulator)
- Manual operation:** See "[Polarity](#)" on page 211

[:SOURce<hw>]:PULM:SOURce <Source>

Selects the source for the pulse modulation signal.

Parameters:

<Source> INTernal | EXTernal

INTernal

The internally generated rectangular signal is used for the pulse modulation. The frequency of the internal signal can be set in the `SOURce:LFOutput` subsystem.

EXTernal

The signal applied externally via the EXT MOD connector is used for the pulse modulation.

*RST: INTernal

- Example:** PULM:SOUR INT
selects the internal modulation source.
PULM:STAT ON
activates the pulse modulation.

- Usage:** SCPI confirmed
- Options:** R&S SMB-K21 or R&S SMB-K22 (Pulse Modulator)

Manual operation: See ["Source"](#) on page 211

[:SOURce<hw>]:PULM:STATe <State>

Activates the pulse modulation.

Parameters:

<State> 0 | 1 | OFF | ON
 *RST: 0

Example:

PULM:STAT ON
 activates pulse modulation.

Options: R&S SMB-K21 or R&S SMB-K22 (Pulse Modulator)

Manual operation: See ["State"](#) on page 211

[:SOURce<hw>]:PULM:TRAI:n:CATalog?

Queries a list of available pulse train files. The individual pulse train files are separated by commas.

The files are stored with the fixed file extensions `*.pulstrn` in a directory of the user's choice. The directory applicable to the commands is defined with the command `MMEMoRY:CDIR`.

Return values:

<Catalog> string

Example:

MMEM:CDIR '/var/user/Lists'
 selects the directory for the pulse train files.
 PULM:TRA:CAT?
 queries the available files.
 Response: 'P_CONS', 'P_INCR', 'P_DECR'
 the lists P_CONS, P_INCR and P_DECR are available.

Usage: Query only

Options: R&S SMB-K27 (Pulse Train)

Manual operation: See ["Pulse Train Data – Pulse Generator"](#) on page 231

[:SOURce<hw>]:PULM:TRAI:n:DELeTe <Filename>

Deletes the specified pulse train file.

The files are stored with the fixed file extensions `*.pulstrn` in a directory of the user's choice. The directory applicable to the command is defined with the command `MMEMoRY:CDIR`. To access the files in this directory, only the file name has to be given without the path and the file extension.

Setting parameters:

<Filename> <list file name>

- Example:** `MMEM:CDIR '/var/user/Lists'`
selects the directory for the pulse train files.
`PULM:TRA:DEL 'P_FIVE'`
deletes the list `P_FIVE`
- Usage:** Setting only
- Options:** R&S SMB-K27 (Pulse Train)
- Manual operation:** See "[Pulse Train Data – Pulse Generator](#)" on page 231

[[:SOURce<hw>]:PULM:TRAin:OFFTime <OffTime>

Fills the Off-time part of the selected file with data.

*RST does not affect data lists.

Parameters:

<OffTime> Offtime#1{, Offtime#2, ...} | binary block data
The data can be given either as a list of numbers (list can be of any length and list entries must be separated by commas) or as binary block data.
When block data is transferred, 8 (4) bytes are always interpreted as a floating-point number with double accuracy (see the command `FORMat:DATA`).
The maximum length is 2047 values.

- Example:** `MMEM:CDIR '/var/user/Lists'`
selects the directory for the pulse train files.
`PULM:TRA:SEL 'P_INCR'`
selects `P_INCR` for editing. `P_INCR` is created if it does not yet exist.
`PULM:TRA:OFFT 10ns,30ns,40ns,...`
specifies the off-time values in `P_INCR`. If the list already contains data, it is overwritten.

- Options:** R&S SMB-K27 (Pulse Train)
- Manual operation:** See "[Edit Pulse Train Data](#)" on page 232

[[:SOURce<hw>]:PULM:TRAin:OFFTime:POINTs?

Queries the length (in points) of the off-time component of the selected list.

Return values:

<Points> integer
Range: 0 to 2047
*RST: 0

Example: MMEM:CDIR '/var/user/Lists'
 selects the directory for the pulse train files.
 PULM:TRA:SEL 'P_INCR'
 selects P_INCR for editing. P_INCR is created if it does not yet exist.
 PULM:TRA:OFFT:POIN?
 queries the number of frequency values in P_INCR
 Response: 7
 P_INCR has 7 off-time entries.

Usage: Query only

Options: R&S SMB-K27 (Pulse Train)

[:SOURce<hw>]:PULM:TRAI:n:ONTime <OnTime>

Fills the On-time part of the selected file with data.

Parameters:

<OnTime> OnTime#1{, OnTime#2, ...} | binary block data
 The data can be given either as a list of numbers (list can be of any length and list entries must be separated by commas) or as binary block data.
 When block data is transferred, 8 (4) bytes are always interpreted as a floating-point number with double accuracy (see the command `FORMat:DATA`).
 The maximum length is 2047 values.

Example: MMEM:CDIR '/var/user/Lists'
 selects the directory for the pulse train files.
 PULM:TRA:SEL 'P_INCR'
 selects P_INCR for editing. P_INCR is created if it does not yet exist.
 PULM:TRA:ONT 10ns,30ns,40ns,...
 specifies the on-time values in P_INCR. If the list already contains data, it is overwritten.

Options: R&S SMB-K27 (Pulse Train)

Manual operation: See ["Edit Pulse Train Data"](#) on page 232

[:SOURce<hw>]:PULM:TRAI:n:ONTime:POINts?

Queries the length (in points) of the ontime component of the selected list.

Return values:

<Points> integer
 Range: 0 to 2047
 *RST: 0

Example: MMEM:CDIR '/var/user/Lists'
 selects the directory for the pulse train files.
 PULM:TRA:SEL 'P_INCR'
 selects P_INCR for editing. P_INCR is created if it does not yet exist.
 PULM:TRA:ONT:POIN?
 queries the number of frequency values in P_INCR
 Response: 7
 P_INCR has 7 ontime entries.

Usage: Query only

Options: R&S SMB-K27 (Pulse Train)

[[:SOURce<hw>]:PULM:TRAI:REPetition <Repetition>

Sets the number of repetitions for each ontime/offtime value pair.

*RST does not affect data lists.

Tip:"0" ignores the corresponding value pair in the pulse train. Thus, you can individually omit value pairs without deleting them from the table.

Parameters:

<Repetition> Repetition#1{, Repetition#2, ...}
 Range: 0...65535

Example: MMEM:CDIR '/var/user/Lists'
 selects the directory for the pulse train files.
 PULM:TRA:SEL 'P_INCR'
 selects P_INCR for editing. P_INCR is created if it does not yet exist.
 PULM:TRA:ONT 10ns,30ns,40ns,...
 specifies the ontime values in P_INCR. If the list already contains data, it is overwritten.
 PULM:TRA:OFFT 10ns,30ns,40ns,...
 specifies the offtime values in P_INCR. If the list already contains data, it is overwritten.
 PULM:TRA:REP 1,8,3,...
 specifies the number of repetitions for each value pair.

Options: R&S SMB-K27 (Pulse Train)

Manual operation: See ["Edit Pulse Train Data"](#) on page 232

[[:SOURce<hw>]:PULM:TRAI:REPetition:POINts?

Queries the length (in points) of the repetition component of the selected list.

Return values:

<Points> integer
 Range: 0 to INT_MAX
 *RST: 0

Example: MMEM:CDIR '/var/user/Lists'
 selects the directory for the pulse train files.
 PULM:TRA:SEL 'P_INCR'
 selects P_INCR for editing. P_INCR is created if it does not yet exist.
 PULM:TRA:REP:POIN?
 queries the number of repetition values in P_INCR
 Response: 7
 P_INCR has 7 repetition entries.

Usage: Query only

Options: R&S SMB-K27 (Pulse Train)

[:SOURce<hw>]:PULM:TRAI:n:SELEct <Filename>

Selects the specified pulse train file. If a new file is to be created, the name can be entered here. The file is created if it does not yet exist. The file selected here is available for the further processing steps (editing) and is used in the instrument when the pulse train mode is activated.

The files are stored with the fixed file extensions *.pulstrn in a directory of the user's choice. The directory applicable to the command is defined with the command MMEMory:CDIR.

*RST does not affect data lists.

Parameters:

<Filename> string

Example: MMEM:CDIR '/var/user/Lists'
 selects the directory for the pulse train files.
 PULM:TRA:SEL 'P_INCR'
 selects P_INCR for editing. P_INCR is created if it does not yet exist.

Options: R&S SMB-K27 (Pulse Train)

Manual operation: See ["Pulse Train Data – Pulse Generator"](#) on page 231

[:SOURce<hw>]:PULM:TRIGger:EXTernal:GATE:POLarity <Polarity>

Selects the polarity of the Gate signal.

The signal is supplied via the PULSE EXT connector.

Parameters:

<Polarity> NORMal | INVerted
 *RST: NORMal

Example: PULM:TRIG:EXT:GATE:POL NORM
 The pulse signal is generated while the gate signal is high.

Options: R&S SMB-K23 (Pulse Generator)

Manual operation: See ["Gate Input Polarity - Pulse Generator"](#) on page 229

[[:SOURce<hw>]:PULM:TRIGger:EXTernal:IMPedance <Impedance>

Selects the impedance for external pulse trigger.

Parameters:

<Impedance> G50 | G10K
 *RST: G50

Example:

SOUR:PULM:TRIG:EXT:IMP G50
 selects 50 Ohm as the trigger impedance for the external pulse trigger.

Options: R&S SMB-K21 or R&S SMB-K22 (Pulse Modulator)

Manual operation: See ["External Impedance"](#) on page 229

[[:SOURce<hw>]:PULM:TRIGger:EXTernal:SLOPe <Slope>

Sets the polarity of the active slope of an applied trigger at the PULSE EXT connector.

Parameters:

<Slope> NEGative | POSitive
 *RST: POSitive

Example:

PULM:TRIG:EXT:SLOP NEG
 The pulse generator is triggered on the negative slope of the external trigger signal.

Options: R&S SMB-K23 (Pulse Generator)

Manual operation: See ["External Trigger Input Slope - Pulse Generator"](#) on page 229

[[:SOURce<hw>]:PULM:TRIGger:MODE <Mode>

Selects the trigger mode for pulse modulation.

Parameters:

<Mode> AUTO | EXTeRnal | EGATe | SINGle

AUTO

The pulse modulation is generated continuously.

EXTeRnal

The pulse modulation is triggered by an external trigger event. The trigger signal is supplied via the PULSE EXT connector.

EGATe

The pulse modulation is gated by an external gate signal. The signal is supplied via the PULSE EXT connector.

SINGle

Pulse modulation is generated once.

*RST: AUTO

Example:

```
PULM:TRIG:MODE EXT
selects triggering by an external trigger event.
```

Options:

R&S SMB-K23 (Pulse Generator)

Manual operation: See ["Trigger Mode - Pulse Generator"](#) on page 228

[:SOURce]:PULM[:INTeRnal][:TRAIIn]:TRIGger:IMMeDiate

Initiates an internal single trigger signal for the pulse generator.

Example:

```
PULM:TRIG:MODE SING
PULM:TRIG:IMM
```

Manual operation: See ["Execute Single Trigger"](#) on page 229

[:SOURce<hw>]:PULM:TRAIIn:DEXChange:AFILe:CATalog?

The command requests a list of available ASCII files for export/import of pulse train data. The individual files are separated by commas.

The ASCII files are stored with the fixed file extensions *.txt or *.csv in a directory of the user's choice. The directory applicable to the commands is defined with the command MMeMory:CDIR.

Return values:

<Catalog> string

Example:

```
MMeM:CDIR '/var/user/Lists/import'
selects the directory for the ASCII files with ontime/offtime/repe-
tition values.
PULM:TRA:DEXC:AFIL:EXT TXT
selects that ASCII files with extension *.txt are listed.
PULM:TRA:DEXC:AFIL:CAT?
queries the available files with extension *.txt.
Response: 'train1','train2'
the ASCII files train1.txt and train2.txt are available.
```

Usage:	Query only
Options:	R&S SMB-K27 (Pulse Train)
Manual operation:	See " Select ASCII Source / Destination - Import/Export Pulse Train Files " on page 234

[:SOURce<hw>]:PULM:TRAI:n:DEXChange:AFILe:EXTension <Extension>

The command selects the file extension of the ASCII file to be imported or exported. Selection `TEXT` (text file) or `CSV` (Excel file) is available.

Parameters:

<Extension> `TEXT | CSV`
 *RST: `TEXT`

Example:

```
MMEM:CDIR '/var/user/Lists/import'
selects the directory for the ASCII files with ontime/offtime/repetition values.
PULM:TRA:DEXC:AFIL:EXT TEXT
selects that ASCII files with extension *.txt are listed.
PULM:TRA:DEXC:AFIL:CAT?
queries the available files with extension *.txt.
Response: 'train1','train2'
the ASCII files train1.txt and train2.txt are available.
```

Options: R&S SMB-K27 (Pulse Train)

Manual operation: See "[Extension – ASCII File Settings](#)" on page 233

[:SOURce<hw>]:PULM:TRAI:n:DEXChange:AFILe:SElect <Filename>

The command selects the ASCII file to be imported or exported.

The ASCII files are stored with the fixed file extensions `*.txt` or `*.csv` in a directory of the user's choice. The directory applicable to the commands is defined with the command `MMEMoRY:CDIR`.

Parameters:

<Filename> `string`

Example:

```
MMEM:CDIR '/var/user/Lists/import'
selects the directory for the ASCII files with ontime/offtime/repetition values.
PULM:TRA:DEXC:MODE IMP
selects that ASCII files with ontime/offtime/repetition values are imported and transferred into pulse train lists.
PULM:TRA:DEXC:AFIL:SEL 'train.csv'
selects that ASCII file train.csv is imported.
PULM:TRA:DEXC:SEL 'train_imp'
selects that the ASCII file train.csv is imported into pulse train list train_imp.
```

Options: R&S SMB-K27 (Pulse Train)

Manual operation: See "[Select ASCII Source / Destination - Import/Export Pulse Train Files](#)" on page 234

[[:SOURce<hw>]:PULM:TRAI:n:DEXChange:AFILe:SEParator:COLumn <Column>

Parameters:

<Column> TABulator | SEMicolon | COMMa | SPACe

*RST: SEMicolon

Example:

PULM:TRA:DEXC:MODE EXP

selects that the pulse train list is exported into an ASCII file.

MMEM:CDIR '/var/user/Lists/import'

selects the directory for the ASCII files with ontime/offtime/repetition values.

PULM:TRA:DEXC:AFIL:SEL 'train.csv'

selects ASCII file train.csv as destination for the pulse train list data.

PULM:TRA:DEXC:AFIL:SEP:COL TAB

the ontime/offtime/repetition values are separated by a tabulator.

PULM:TRA:DEXC:AFIL:SEP:DEC DOT

selects the decimal separator dot.

PULM:TRA:DEXC:SEL 'train_imp'

selects that the pulse train list train_imp is imported into ASCII file train.csv.

Options: R&S SMB-K27 (Pulse Train)

Manual operation: See "[Column Separator- ASCII File Settings](#)" on page 234

[[:SOURce<hw>]:PULM:TRAI:n:DEXChange:AFILe:SEParator:DECimal <Decimal>

Select the decimal separator used in the ASCII data between '.' (decimal point) and ',' (comma) with floating-point numerals.

Parameters:

<Decimal> DOT | COMMa

*RST: DOT

Example:

```
PULM:TRA:DEXC:MODE EXP
```

selects that the pulse train list is exported into an ASCII file.

```
MMEM:CDIR '/var/user/Lists/import'
```

selects the directory for the ASCII files with on-time/off-time/repetition values.

```
PULM:TRA:DEXC:AFIL:SEL 'train.csv'
```

selects ASCII file train.csv as destination for the pulse train list data.

```
PULM:TRA:DEXC:AFIL:SEP:COL TAB
```

the ontime/offtime/repetition values are separated by a tabulator.

```
PULM:TRA:DEXC:AFIL:SEP:DEC DOT
```

selects the decimal separator dot.

```
PULM:TRA:DEXC:SEL 'train_imp'
```

selects that the pulse train list train_imp is imported into ASCII file train.csv.

Options: R&S SMB-K27 (Pulse Train)

Manual operation: See "[Decimal Point - ASCII File Settings](#)" on page 234

[:SOURce<hw>]:PULM:TRAI:n:DEXChange:EXECute

Starts the export or import of the selected file. When import is selected, the ASCII file is imported as pulse train list. When export is selected, the pulse train list is exported into the selected ASCII file.

Example:

```
PULM:TRA:DEXC:MODE IMP
```

selects that ASCII files with ontime/offtime/repetition values are imported and transferred into pulse train lists.

```
MMEM:CDIR '/var/user/Lists/import'
```

selects the directory for the ASCII files with on-time/off-time/repetition values.

```
PULM:TRA:DEXC:AFIL:SEL 'train.csv'
```

selects that ASCII file train.csv is imported.

```
PULM:TRA:DEXC:SEL 'train_imp'
```

selects that the ASCII file train.csv is imported into pulse train list train_imp.

```
PULM:TRA:DEXC:EXEC
```

starts the import of the ASCII file data into the pulse train file.

Usage: Event

Options: R&S SMB-K27 (Pulse Train)

Manual operation: See "[Import / Export - Import/Export Pulse Train Files](#)" on page 234

[:SOURce<hw>]:PULM:TRAI:n:DEXChange:MODE <Mode>

Selects if pulse train lists should be imported or exported. Depending on the selection, the file select command define either the source or the destination for pulse train lists and ASCII files.

Parameters:

<Mode> IMPort | EXPort
 *RST: IMPort

Example:

```
PULM:TRA:DEXC:MODE IMP
selects that ASCII files with ontime/offtime/repetition values are
imported and transferred into pulse train lists.
MMEM:CDIR '/var/user/Lists/import'
selects the directory for the ASCII files with ontime/offtime/repe-
tition values.
PULM:TRA:DEXC:AFIL:SEL 'train.csv'
selects that ASCII file train.csv is imported.
PULM:TRA:DEXC:SEL 'train_imp'
selects that the ASCII file train.csv is imported into pulse
train list train_imp.
```

Options: R&S SMB-K27 (Pulse Train)

Manual operation: See "[Mode – Import/Export Pulse Train Files](#)" on page 233

[:SOURce<hw>]:PULM:TRAI:n:DEXChange:SElect <Filename>

The command selects the pulse train list to be imported or exported.

The pulse train files are stored with the fixed file extensions *.pulstrn in a directory of the user's choice. The directory applicable to the commands is defined with the command MMEMoRY:CDIR.

Parameters:

<Filename> string

Example:

```
PULM:TRA:DEXC:MODE IMP
selects that ASCII files with ontime/offtime/repetition values are
imported and transferred into pulse train lists.
MMEM:CDIR '/var/user/Lists/import'
selects the directory for the ASCII files with ontime/offtime/repe-
tition values.
PULM:TRA:DEXC:AFIL:SEL 'train.csv'
selects that ASCII file train.csv is imported.
PULM:TRA:DEXC:SEL 'train_imp'
selects that the ASCII file train.csv is imported into pulse
train list train_imp.
```

Options: R&S SMB-K27 (Pulse Train)

Manual operation: See "[Select Destination / Source - Import/Export Pulse Train Files](#)" on page 234

[:SOURce<hw>]:PULM:WIDTh <Width>

Sets the width of the generated pulse. The width determines the pulse length. The pulse width must be at least 20ns less than the set pulse period.

Parameters:

<Width> float
 Range: 10 ns to 100 s
 Increment: 10 ns
 *RST: 2 us

Example:

PULM:WIDT 33 us
 sets a width of 33 us for the pulse.

Options:

R&S SMB-K23 (Pulse Generator)

Manual operation: See "Pulse Width - Pulse Generator" on page 228

7.13.14 SOURce:ROSCillator Subsystem

This subsystem contains the commands for setting the external and internal reference frequency.



The settings of the reference oscillator are not affected by an instrument reset (*RST on page 282). They are only reset to factory state by the factory-preset (:SYSTem:FPReset on page 285).

[:SOURce]:ROSCillator:EXTernal:FREQUENCY.....	405
[:SOURce]:ROSCillator:EXTernal:RFOF[:STATe].....	406
[:SOURce]:ROSCillator:EXTernal:SBANdwidth.....	406
[:SOURce]:ROSCillator[:INTernal]:ADJust:VALue.....	406
[:SOURce]:ROSCillator[:INTernal]:ADJust[:STATe].....	407
[:SOURce]:ROSCillator:SOURce.....	407

[:SOURce]:ROSCillator:EXTernal:FREQUENCY <Frequency>

Selects the external reference frequency.

Note: The installed hardware determines the available settings. Use the [Hardware Config](#) dialog to check the hardware the instrument is equipped with.

For information on the required hardware revision, refer to the release notes.

Parameters:

<Frequency> 5MHZ | 10MHZ
 *RST: ---

Example:

ROSC:SOUR EXT
 selects the external source. The reference must be input at the REF IN input.
 ROSC:EXT:FREQ 10MHz
 selects 10 MHz external reference frequency.

Manual operation: See "External Reference Frequency" on page 144

[[:SOURce]:ROSCillator:EXTernal:RFOff[:STATe]] <State>

Activates that RF output is automatically switched off, when in external source mode no reference signal is supplied.

This setting ensures that no improper RF signal due to the missing external reference signal is output and used for measurements.

In addition to the error message "Ext Ref missing", the instrument generates the message "RF output deactivated".

Parameters:

<State> 0 | 1 | OFF | ON
*RST: --

Example:

ROSC:SOUR EXT

Selects the external source. The reference must be input at the REF IN input.

Example:

ROSC:EXT:RFOF:STAT ON

In case of a missing external signal, no RF signal is output.

Manual operation: See "[Deactivate RF Output \(if external reference is missing\)](#)" on page 143

[[:SOURce]:ROSCillator:EXTernal:SBANdwidth] <SBandwidth>

Sets the synchronization bandwidth for an external reference signal.

Parameters:

<SBandwidth> WIDE | NARROW

NARROW

The synchronization bandwidth is approx. 50 Hz.

WIDE

The synchronization bandwidth is approx. 350 Hz.

Example:

ROSC:SOUR EXT

Selects the external source.

ROSC:EXT:FREQ 10 MHz

Informs the instrument that the external reference has a frequency of 10 MHz.

ROSC:EXT:SBAN WID

Selects wideband setting for synchronization bandwidth.

Manual operation: See "[Synchronization Bandwidth](#)" on page 144

[[:SOURce]:ROSCillator[:INTernal]:ADJust:VALue] <Value>

Specifies the frequency correction value (adjustment value).

Parameters:

<Value> integer
 Range: 0 to maximum value (see data sheet)
 Increment: see data sheet
 *RST: ---

Example:

ROSC:ADJ:VAL 456
 Sets the adjustment value to 456.

Manual operation: See "[Adjustment DAC Value](#)" on page 144

[[:SOURce]:ROSCillator[:INTernal]:ADJust[:STATe]] <State>

Determines whether the calibrated (OFF) or a user-defined (ON) adjustment value is used for fine adjustment of the frequency.

If user-defined values are used, the instrument is no longer in the calibrated state. However, the calibration value is not changed and the instrument resumes the calibrated state after sending the command :SOURce:ROSCillator:INTernal:ADJust:STATe OFF.

Parameters:

<State> 0 | 1 | OFF | ON
 *RST: -

Example:

ROSC:SOUR INT
 Selects the internal source.
 ROSC:ADJ ON
 Activates use of a user-defined adjustment value.
 ROSC:ADJ:VAL 1400
 Sets the adjustment value to 1400.

Manual operation: See "[Adjustment Active](#)" on page 144

[[:SOURce]:ROSCillator:SOURce] <Source>

Selects the reference frequency source.

Parameters:

<Source> INTernal | EXTernal | ELOop

INTernal

The internal reference oscillator is used.

EXTernal

An external reference signal is used. It must be input at the REF IN connector at the rear of the instrument.

The instrument is informed of the frequency of the external reference signal by means of the command [[:SOURce]:

ROSCillator:EXTernal:FREQuency.

*RST: ---

Example: ROSC:SOUR EXT
 Selects the external source.
 ROSC:EXT:FREQ 5 MHz
 Informs the instrument that the external reference has a frequency of 5 MHz.

Manual operation: See "Source" on page 143

7.13.15 SOURce:STEReo Subsystem

This subsystem contains the SCPI commands for generating FM stereo multiplex signals, the radio traffic service ARI (Automotive Radio Information) and Radio Data System (RDS). Additional functions are available using the SOURce:STEReo:DIRect commands (see Chapter 7.19, "Direct Commands for the Stereo/RDS Coder Option R&S SMB-B5", on page 456).

[:SOURce]:STEReo:ARI:BK[:CODE]	408
[:SOURce]:STEReo:ARI:STATe	409
[:SOURce]:STEReo:ARI:TYPE	409
[:SOURce]:STEReo:ARI:TYPE:STATe	410
[:SOURce]:STEReo:ARI[:DEViation]	410
[:SOURce]:STEReo:AUDio:MODE	410
[:SOURce]:STEReo:AUDio:PREemphasis	411
[:SOURce]:STEReo:AUDio:PREemphasis:STATe	412
[:SOURce]:STEReo:AUDio[:FREQuency]	412
[:SOURce]:STEReo:DIRect	412
[:SOURce]:STEReo:EXTernal:IMPedance	413
[:SOURce]:STEReo:MMF	413
[:SOURce]:STEReo:PILot:PHASe	413
[:SOURce]:STEReo:PILot:STATe	414
[:SOURce]:STEReo:PILot[:DEViation]	414
[:SOURce]:STEReo:RDS:DATaset	414
[:SOURce]:STEReo:RDS:STATe	414
[:SOURce]:STEReo:RDS:TRAFfic:ANNouncement[:STATe]	415
[:SOURce]:STEReo:RDS:TRAFfic:PROGram[:STATe]	415
[:SOURce]:STEReo:RDS[:DEViation]	415
[:SOURce]:STEReo:SOURce	416
[:SOURce]:STEReo:STATe	416
[:SOURce]:STEReo[:DEViation]	417

[\[:SOURce\]:STEReo:ARI:BK\[:CODE\]](#) <Code>

Selects the area identification (BK) code of the ARI signal. The six letters (six different frequencies) identify a specific region in each country. The code is generated if the BK or DK+BK identifier of the ARI signal is activated.

Parameters:

<Code> A | B | C | D | E | F
 *RST: A

- Example:** `STER:ARI:TYPE BK`
 selects generation of area identification.
`STER:ARI:BK A`
 selects the specific area identification code A to be generated.
- Options:** R&S SMB-B5
- Manual operation:** See "[ARI BK - Stereo Modulation](#)" on page 216

[:SOURce]:STEReo:ARI:STATe <State>

Activates/deactivates the ARI signal generation. ARI signals can be generated simultaneously with MPX and RDS signals.

Parameters:

<State> 0 | 1 | OFF | ON
 *RST: OFF

Example: `STER:ARI:STAT ON`
 activates generation of an ARI signal.

Options: R&S SMB-B5

Manual operation: See "[ARI State - Stereo Modulation](#)" on page 216

[:SOURce]:STEReo:ARI:TYPE <Type>

Selects the generated identifiers of the ARI signal.

Parameters:

<Type> OFF | DK | BK | BKDK

OFF

Only the 57 kHz subcarrier is generated (Senderkennung). It marks the stations which broadcast traffic programs and enables the receiver to recognize the frequency as being ARI-capable.

DK

The message identification (Durchsagekennung) is generated in addition (low-frequency 30% AM). It signalizes that a traffic message is currently broadcasted.

BK

The area identification (Bereichskennung) is generated in addition (60% AM). This code is used to identify the geographical region covered by the radio station. The specific code is selected below.

BKDK

The area and message identification are generated in addition.

*RST: DK

Example: `STER:ARI:TYPE BKDK`
 A complete ARI signal with all identifiers is generated.

Options: R&S SMB-B5

Manual operation: See "[ARI Identification - Stereo Modulation](#)" on page 216

[[:SOURce]:STEReo:ARI:TYPE:STATe <State>

Activates/deactivates the Stereo ARI Identifier.

Parameters:

<State> 0 | 1 | OFF | ON
 *RST: 0

Example: STER:ARI:TYPE:STAT ON

Options: R&S SMB-B5

[[:SOURce]:STEReo:ARI[:DEViation] <Deviation>

Sets the frequency deviation of the ARI subcarrier signal.

Parameters:

<Deviation> integer
 Range: 0 to 10000
 *RST: 3500

Example: STER:ARI:DEV 3.5kHz
 sets the frequency deviation of the 57 kHz subcarrier to 3.5kHz.

Options: R&S SMB-B5

Manual operation: See "[ARI Deviation - Stereo Modulation](#)" on page 216

[[:SOURce]:STEReo:AUDio:MODE <Mode>

Selects the generated identifiers of the AUDio signal.

Parameters:

<Mode>

LEFT | RIGHT | RELeft | REMLeft | RNELeft

LEFT

A mono signal containing the left channel is generated/fed in.

RIGHT

A mono signal containing the right channel is generated/fed in.

RELeft

A stereo signal with right and left channel is generated/fed in. The channels have the same frequency and phase.

REMLeft

The signal on the left external audio input is used for both channels, left and right. The right channel is inverted.

RNELeft

(External source only)

A stereo signal containing different, independent right and left channels is feed in. It is possible, for example, to feed a fixed audio frequency to the first channel while a frequency sweep is being performed in the second channel.

*RST: RIGHT

Example:

STER:SOUR LFG

The internal LF generator is used as modulation source for the audio signal.

STER:AUD:MODE RIGH

A mono signal containing the left channel is generated.

Options:

R&S SMB-B5

Manual operation:See "[Mode - Stereo Modulation](#)" on page 214**[:SOURce]:STEReo:AUDio:PREEmphasis <PreEmphasis>**

Sets the preemphasis used for signal generation.

Parameters:

<PreEmphasis>

float

Range: 50 us to 75 us

Example:

STER:SOUR LFG

The internal LF generator is used as modulation source for the audio signal.

STER:AUD:PRE 50µs

sets preemphasis to 50µs.

STER:AUD:PRE:STAT ON

activates preemphasis.

Options:

R&S SMB-B5

Manual operation:See "[Preemphasis - Stereo Modulation](#)" on page 214

[[:SOURce]:STEReo:AUDio:PREemphasis:STATe <State>

Activates the use of preemphasis for signal generation.

Parameters:

<State> 0 | 1 | OFF | ON
*RST: OFF

Example:

```
STER:SOUR LFG
The internal LF generator is used as modulation source for the
audio signal.
STER:AUD:PRE 50µs
sets preemphasis to 50µs.
STER:AUD:PRE:STAT ON
activates preemphasis.
```

Options: R&S SMB-B5

Manual operation: See "[Preemphasis - Stereo Modulation](#)" on page 214

[[:SOURce]:STEReo:AUDio[:FREQuency] <Frequency>

Sets the frequency of the LF generator signal. The command is an alias to command `SOURce:LFOutput:FREQuency`.

Parameters:

<Frequency> float
Range: 0.1 to 1E6
Increment: 0.01
*RST: 1000

Example:

```
STER:SOUR LFG
The internal LF generator is used as modulation source for the
audio signal.
STER:AUD:FREQ 1100
sets the frequency of the audio signal to 1.1 kHz
```

Options: R&S SMB-B5

Manual operation: See "[LF Gen Freq - Stereo Modulation](#)" on page 214

[[:SOURce]:STEReo:DIRect <Direct>

Sends a R&S SMB command string to the stereo coder. The direct commands offer extended settings possibilities for the stereo coder (see [Chapter 7.19, "Direct Commands for the Stereo/RDS Coder Option R&S SMB-B5"](#), on page 456).

Parameters:

<Direct> string

Example:

```
STER:DIR 'ARI-ID=0'
deactivates the ARI identification.
```

Options: R&S SMB-B5

Manual operation: See ["RDS Program Service Name - Stereo Modulation"](#) on page 217

[[:SOURce]:STEReo:EXTernal:IMPedance <Impedance>

Selects the input impedance for the external analog audio signal inputs L and R.

Parameters:

<Impedance> 600 | 600Ohm | 100000 | 100kOhm | 100000Ohm
 *RST: 100000

Example:

SOUR:STER:EXT:IMP 600Ohm
 selects 600 OHM as the impedance for the external analog audio signals.

Options: R&S SMB-B5

Manual operation: See ["External R/L Impedance - Stereo Modulation"](#) on page 214

[[:SOURce]:STEReo:MMF <Mmf>

Sets the maximum possibly used modulation frequency. This setting is only effective for external modulation source and activated preemphasis. It prevents over modulation but result in a decreased s/n ratio.

Parameters:

<Mmf> integer
 Range: 1000 to 18000
 *RST: 1000

Example:

SOUR:STER:MMF 2000
 sets a maximum modulation frequency of 2 kHz.

Options: R&S SMB-B5

Manual operation: See ["Max Modulation Freq- Stereo Modulation"](#) on page 215

[[:SOURce]:STEReo:PILot:PHASe <Phase>

Sets the phase of the pilot tone in degrees, in relation to the 38 kHz carrier signal of the receiver. For a correct demodulation, the pilot tone must be in phase with the 38 kHz carrier.

Parameters:

<Phase> float
 Range: -5 to 5
 Increment: 0.1
 *RST: 0

Example:

SOUR:STER:PIL:PHAS .2DEG
 decreases pilot tone quality by adding a phase difference of 0.2 degrees between pilot signal and receiver carrier signal.

Options: R&S SMB-B5

Manual operation: See "[Pilot Phase - Stereo Modulation](#)" on page 215

[[:SOURce]:STEReo:PILot:STATe <State>

Activates/deactivates the pilot tone generation.

Parameters:

<State> 0 | 1 | OFF | ON
*RST: OFF

Example: STER:PIL:STAT ON
activates generation of the pilot tone.

Options: R&S SMB-B5

Manual operation: See "[Pilot State - Stereo Modulation](#)" on page 215

[[:SOURce]:STEReo:PILot[:DEViation] <Deviation>

Sets the deviation of the pilot tone.

Parameters:

<Deviation> integer
Range: 0 to 10 kHz
*RST: 6.75 kHz

Example: SOUR:STER:PIL:DEV 6.75kHz
sets the pilot tone deviation according to standard.

Options: R&S SMB-B5

Manual operation: See "[Pilot Deviation - Stereo Modulation](#)" on page 215

[[:SOURce]:STEReo:RDS:DATaset <Dataset>

Selects one of the five data sets provided on the instrument for use in the RDS signal.

Parameters:

<Dataset> DS1 | DS2 | DS3 | DS4 | DS5
*RST: DS1

Example: STER:RDS:DAT DS5
activates use of data set 5 for generation of the RDS signal.

Options: R&S SMB-B5

Manual operation: See "[RDS Data Set - Stereo Modulation](#)" on page 217

[[:SOURce]:STEReo:RDS:STATe <State>

Activates/deactivates the RDS signal generation. RDS signals can be generated simultaneously with MPX and ARI signals.

Parameters:

<State> 0 | 1 | OFF | ON
 *RST: OFF

Example:

STER:RDS:STAT ON
 activates generation of RDS signal.

Options:

R&S SMB-B5

Manual operation: See ["RDS State - Stereo Modulation"](#) on page 216

[[:SOURce]:STEReo:RDS:TRAFfic:ANNouncement[:STATe]] <State>

Activates the RDS traffic announcement. If activated, the receiver switches from the current status, e.g. playing a CD, to the receive mode and enables the broadcast of a traffic announcement. The TP state has to be on.

Parameters:

<State> 0 | 1 | OFF | ON
 *RST: OFF

Example:

STER:RDS:TRAF:PROG:STAT ON
 activates RDS traffic program.
 STER:RDS:TRAF:ANN:STAT ON
 activates RDS traffic announcement.

Options:

R&S SMB-B5

Manual operation: See ["RDS Traffic Announcement State - Stereo Modulation"](#) on page 218

[[:SOURce]:STEReo:RDS:TRAFfic:PROG:STATe]] <State>

Activates the RDS traffic program. The receiver can recognize a frequency as being capable of traffic information only if the TP function is active.

Parameters:

<State> 0 | 1 | OFF | ON
 *RST: OFF

Example:

STER:RDS:TRAF:PROG:STAT ON
 activates the RDS traffic program.

Options:

R&S SMB-B5

Manual operation: See ["RDS Traffic Program State - Stereo Modulation "](#) on page 217

[[:SOURce]:STEReo:RDS[:DEViation]] <Deviation>

Sets the deviation of the RDS subcarrier.

Parameters:

<Deviation> integer
 Range: 0 to 10 kHz
 *RST: 2 kHz

Example:

SOUR:STER:RDS:DEV 2kHz
 sets the RDS signal deviation according to standard.

Manual operation: See "[RDS Deviation - Stereo Modulation](#)" on page 217

[:SOURce]:STEReo:SOURce <Source>

Selects the source for the audio signal.

Parameters:

<Source> OFF | LREXt | SPEXt | LFGen

OFF

No audio signal is provided, ARI and RDS signal can be generated separately.

LREX

The external audio signal is feed in via the analog L and R inputs.

SPEX

The external audio signal is feed in via the digital S/P DIF interface

LFG

The audio stereo signal is internally generated by the LF generator.

*RST: LREXt

Example:

STER:SOUR LFG
 The internal LF generator is used as modulation source for the audio signal.

Options:

R&S SMB-B5

Manual operation: See "[Audio Source - Stereo Modulation](#)" on page 213

[:SOURce]:STEReo:STATe <State>

Activates/deactivates stereo modulation.

Parameters:

<State> 0 | 1 | OFF | ON
 *RST: OFF

Example:

STER:STAT ON
 activates generation of stereo signal.

Options:

R&S SMB-B5

Manual operation: See "[State - Stereo Modulation](#)" on page 213

[:SOURce]:STEReo[:DEVIation] <Deviation>

Sets the MPX (Multiplex stereo signal) deviation.

Parameters:

<Deviation> integer
 Range: 0 to depends on instrument hardware
 *RST: 40 kHz

Example: STER 40kHz
 sets the stereo deviation according to standard.

Options: R&S SMB-B5

Manual operation: See "[FM Deviation - Stereo Modulation](#)" on page 213

7.13.16 SOURce:SWEep Subsystem

The SOURce : subsystem contains the commands for configuring RF sweep signals.



- The keyword [:FREQuency] can be omitted, then the commands are SCPI-compliant.
- To activate a RF sweep mode, use the following commands:
 - RF frequency sweep: SOURce:FREQuency:MODE SWEep (SOURce:FREQuency:MODE CW (off))
 - RF level sweep: SOURce:POWer:MODE SWEep (SOURce:POWer:MODE CW (off))
- All sweeps, including the LF sweep, can be set independently from each other.

This example shows how to set up a frequency sweep.

1. Set the sweep range.

```
[SOURce:]FREQuency:CENTer 200 MHz
[SOURce:]FREQuency:SPAN 300 MHz
```
2. Select linear or logarithmic spacing.

```
[SOURce:]SWEep[:FREQuency]:SPACing LIN
```
3. Set the step width and dwell time.

```
[SOURce:]SWEep[:FREQuency]:STEP:LINear 20 MHz
[SOURce:]SWEep[:FREQuency]:DWELL 12 ms
```
4. Select the trigger mode.

```
TRIGger:]FSweep:SOURce SINGLE
```
5. Select the sweep mode and activate the sweep.

```
[SOURce:]SWEep[:FREQuency]:MODE AUTO
[SOURce:]FREQuency:MODE SWEep
```
6. Trigger the sweep.

[SOURce:]SWEep[:FREQUENCY]:EXECute



It is recommended that you switch off the "Start/Stop Display Update" for optimum sweep performance, especially with short dwell times (SYSTem:DISPlay:UPDate OFF).

[SOURce<hw>]:SWEep[:FREQUENCY]:DWELI.....	418
[SOURce<hw>]:SWEep[:FREQUENCY]:EXECute.....	419
[SOURce<hw>]:SWEep[:FREQUENCY]:LFConnector.....	419
[SOURce<hw>]:SWEep[:FREQUENCY]:MODE.....	419
[SOURce<hw>]:SWEep[:FREQUENCY]:OVOLTage:START.....	420
[SOURce<hw>]:SWEep[:FREQUENCY]:OVOLTage:STOP.....	421
[SOURce<hw>]:SWEep[:FREQUENCY]:POINTs.....	421
[SOURce<hw>]:SWEep[:FREQUENCY]:RETRace.....	422
[SOURce<hw>]:SWEep[:FREQUENCY]:RUNNING?.....	422
[SOURce<hw>]:SWEep[:FREQUENCY]:SHAPE.....	422
[SOURce<hw>]:SWEep[:FREQUENCY]:SPACing.....	423
[SOURce<hw>]:SWEep[:FREQUENCY]:STEP[:LINear].....	423
[SOURce<hw>]:SWEep[:FREQUENCY]:STEP:LOGarithmic.....	424
[SOURce<hw>]:SWEep:POWER:DWELI.....	425
[SOURce<hw>]:SWEep:POWER:EXECute.....	425
[SOURce<hw>]:SWEep:POWER:MODE.....	425
[SOURce<hw>]:SWEep:POWER:POINTs.....	426
[SOURce<hw>]:SWEep:POWER:RETRace.....	427
[SOURce<hw>]:SWEep:POWER:RUNNING?.....	427
[SOURce<hw>]:SWEep:POWER:SHAPE.....	427
[SOURce<hw>]:SWEep:POWER:SPACing:MODE?.....	428
[SOURce<hw>]:SWEep:POWER:STEP[:LOGarithmic].....	428
[SOURce<hw>]:SWEep:RESet[:ALL].....	429

[SOURce<hw>]:SWEep[:FREQUENCY]:DWELI <Dwell>

Sets the time taken for each frequency step of the sweep.

The keyword [:FREQUENCY] can be omitted (see example). The command is then SCPI-compliant.

Tip: It is recommended to switch off the "Display Update" for optimum sweep performance especially with short dwell times (SYSTem:DISPlay:UPDate OFF).

Parameters:

<Dwell>	float
	Range: 2E-3 to 100
	Increment: 100E-6
	*RST: 15E-3

Example:

SWE:DWEL 12 ms
sets a dwell time of 12 ms for a frequency sweep at the RF output.

Manual operation: See "Dwell Time - Frequency Sweep" on page 181

[:SOURce<hw>]:SWEep[:FREQuency]:EXECute

Starts an RF frequency sweep cycle manually.

The command is only effective in single mode.

Example: TRIG:FSW:SOUR SING
 SOUR:SWE:FREQ:MODE AUT
 SWE:FREQ:EXEC
 triggers a frequency sweep at the RF output.

Usage: Event

Manual operation: See ["Execute Single Sweep - Frequency Sweep"](#) on page 178

[:SOURce<hw>]:SWEep[:FREQuency]:LFConnector <LfConnector>

Activates the output of a sweep voltage ramp at the LF connector.

The voltage range is set with commands

SOURce:SWEep:FREQuency:OVOLtage:STARt and ...:STOP

Parameters:

<LfConnector> 0 | 1 | OFF | ON
 *RST: 0

Example: SWE:LFC ON
 activates the output of a linear voltage ramp from sweep start to
 sweep stop at the LF connector.
 SWE:OVOL:STAR 0V
 SWE:OVOL:STOP 3V
 'the voltage at sweep start is 0 Volt and at sweep stop 3 V.

Manual operation: See ["Use LF connector to output sweep voltage - RF Frequency Sweep"](#) on page 181

[:SOURce<hw>]:SWEep[:FREQuency]:MODE <Mode>

Sets the sweep mode.

The keyword [:FREQuency] can be omitted (see example). The command is then SCPI-compliant.

Parameters:

<Mode> AUTO | MANual | STEP

AUTO

Each trigger triggers exactly one complete sweep.

MANual

The trigger system is not active. Each frequency step of the sweep is triggered individually, either by varying the "Current Frequency" value using the rotary knob under manual control or by means of a `FREQ:MAN` command under remote control. With manual control, the frequency increases or decreases (depending on the direction of the rotary encoder) by the value specified under `FREQ:STEP:INCRement`. With remote control, the frequency is set directly with the command `:FREQ:MAN`.

STEP

Each trigger triggers one sweep step only (Mode Single Step). The frequency increases by the value entered under `SOUR:SWE:FREQ:STEP:LIN` (linear spacing) or `...:STEP:LOG` (logarithmic spacing).

*RST: AUTO

Example:

`SWE:MODE AUTO`

selects **Mode Auto** for a frequency sweep at the RF output.

Manual operation: See "[Mode - RF Frequency Sweep](#)" on page 176

[SOURce<hw>]:SWEep[:FREQUENCY]:OVOLTage:STARt <Start>

Sets the voltage at the sweep stop frequency. The linear voltage ramp from sweep start to stop is output at the LF connector.

Parameters:

<Start> float
 Range: -3 to 3
 Increment: 1E-3
 *RST: 0

Example:

`SWE:LFC ON`

activates the output of a linear voltage ramp from sweep start to sweep stop at the LF connector.

`SWE:OVOL:STAR 0V`

`SWE:OVOL:STOP 3V`

the voltage at the sweep start frequency is 0 V and at the stop frequency 3 V.

Manual operation: See "[Output Voltage Start Freq - RF Frequency Sweep](#)" on page 181

[:SOURce<hw>]:SWEep[:FREQUENCY]:OVOLtage:STOP <Stop>

Sets the voltage at the sweep stop frequency. The linear voltage ramp from sweep start to stop is output at the LF connector.

Parameters:

<Stop> float
 Range: -3 to 3
 Increment: 1E-3
 *RST: 3

Example:

SWE:LFC ON
 activates the output of a linear voltage ramp from sweep start to sweep stop at the LF connector.
 SWE:OVOL:STAR 0V
 SWE:OVOL:STOP 3V
 the voltage at the sweep start frequency is 0 V and at the stop frequency 3 V.

Manual operation: See ["Output Voltage Stop - RF Frequency Sweep"](#) on page 182

[:SOURce<hw>]:SWEep[:FREQUENCY]:POINts <Points>

Determines the number of steps for the RF frequency sweep within the sweep range.

This parameter always applies to the currently set sweep spacing and correlates with the step size as follows:

- for linear sweeps

$$\text{freq_points} = (f_{\text{SPAN}} / \text{step_lin}) + 1$$
 To determine the step size, use the command [SWE:STEP\[:LIN\]](#).
- logarithmic sweeps and $f_{\text{START}} < f_{\text{STOP}}$

$$\text{freq_points} = ((\log f_{\text{STOP}} - \log f_{\text{START}}) / \log \text{step_log}) + 1$$
 To determine the logarithmic step size, use the command [SWE:STEP:LOG](#).

If you change the number of sweep points, the step size changes accordingly. The sweep range remains the same.

Parameters:

<Points> integer
 Range: 2..max

Example:

FREQ:STAR
 sets the start frequency to 100 MHz.
 FREQ:STOP
 sets the stop frequency to 500 MHz.
 SWE:SPAC LIN
 sets linear sweep spacing.
 SWE:POIN 401
 sets 401 sweep steps for linear sweep spacing. The sweep step width (STEP) is automatically set to 1 MHz.

[:SOURce<hw>]:SWEep[:FREQuency]:RETRace <State>

Activates that the signal changes to the start frequency value while it is waiting for the next trigger event.

You can enable this feature, when you are working with sawtooth shapes in sweep mode "Single" or "External Single".

Parameters:

<State> 0 | 1 | OFF | ON
*RST: 0

Example:

```
TRIG0:SWE:SOUR SING
FREQ:MODE SWE
SWE:SHAP SAWT
SWE:RETR ON
```

activates retrace function, i.e. the frequency changes to the value at start frequency while waiting for the next trigger event.

Manual operation: See ["Retrace - RF Frequency Sweep"](#) on page 180

[:SOURce<hw>]:SWEep[:FREQuency]:RUNNing?

Queries the current state of the frequency sweep mode.

Return values:

<State> 0 | 1 | OFF | ON

Example:

```
SWE:RUNN?
```

Response "1": signal generation in level sweep active.

Usage:

Query only

[:SOURce<hw>]:SWEep[:FREQuency]:SHAPE <Shape>

Sets the cycle mode for a sweep sequence (shape).

Parameters:

<Shape> SAWTooth | TRIangle

SAWTooth

One sweep runs from start to stop frequency. Each subsequent sweep starts at the start frequency, i.e. the shape of the sweep sequence resembles a sawtooth.

TRIangle

One sweep runs from start to stop frequency and back, i.e. the shape of the sweep resembles a triangle. Each subsequent sweep starts at the start frequency.

*RST: SAWTooth

Example:

```
SOUR:SWE:SHAP TRI
```

selects the sweep cycle with alternating ascending and descending sweep directions.

Manual operation: See "Shape - RF Frequency Sweep" on page 179

[:SOURce<hw>]:SWEep[:FREQuency]:SPACing <Spacing>

Selects the mode for the calculation of the frequency sweep intervals. The frequency increases or decreases by this value at each step.

The keyword [:FREQuency] can be omitted. Then the command is SCPI-compliant.

Parameters:

<Spacing> LINear | LOGarithmic

LINear

With the linear sweep, the step width is a fixed frequency value which is added to the current frequency. The step width for linear sweep is entered in Hz (see [:SOURce<hw>]:SWEep[:FREQuency]:STEP[:LINear] on page 423).

LOGarithmic

With the logarithmic sweep, the step width is a constant fraction of the current frequency. This fraction is added to the current frequency. The logarithmic step width is entered in % (see [:SOURce<hw>]:SWEep[:FREQuency]:STEP:LOGarithmic on page 424).

*RST: LINear

Example:

SWE:SPAC LIN

selects linear sweep spacing for a frequency sweep at the RF output.

Manual operation: See "Spacing - Frequency Sweep" on page 179

[:SOURce<hw>]:SWEep[:FREQuency]:STEP[:LINear] <Linear>

Sets the step size for linear RF frequency sweep steps.

This parameter is related to the number of steps ([:SOURce<hw>]:SWEep[:FREQuency]:POINTs) within the sweep range as follows:

$$f_{\text{START}} < f_{\text{STOP}}$$

$$\text{freq_points} = (f_{\text{SPAN}} / \text{step_lin}) + 1$$

If you change the step size, the number of steps changes accordingly. The sweep range remains the same.

The keywords [:FREQuency] and [:LINear] can be omitted. The command is then SCPI-compliant.

Parameters:

<Linear> float

Range: full frequency range

Increment: see the data sheet: RF characteristics > Resolution of setting

Example:

```
FREQ:STAR 1GHz
sets the start frequency to 1 GHz.
FREQ:STOP 5GHz
sets the stop frequency to 5 GHz.
SWE:SPAC LIN
sets linear sweep spacing.
SWE:STEP 2 MHz
sets the step width for linear sweep spacing to 2 MHz (RF
sweep) at the RF output. The number of sweep steps for linear
sweep spacing (POINTS) is automatically set to 2001.
```

Manual operation: See "[Step Lin/Log - Frequency Sweep](#)" on page 180

[[:SOURce<hw>]:SWEep[:FREQUENCY]:STEP:LOGarithmic <Logarithmic>

Sets a logarithmically determined sweep step size for the RF frequency sweep. It is expressed in percent and you must enter the *value* and the unit *PCT* with the command.

The frequency is increased by a logarithmically calculated fraction of the current frequency according to:

$$\text{step_log}_{n+1} = f_n + \text{step_log}_n \times f_n$$

$$f_{n+1} = f_n + \text{step_log}_{n+1}$$

with $f_{\text{START}} < f_{\text{STOP}}$ and $n = \text{number of sweep steps}$

This parameter correlates with the number of steps [SWE:FREQ:POIN](#) within the sweep range as follows:

$$\text{freq_points} = ((\log f_{\text{STOP}} - \log f_{\text{START}}) / \log \text{step_log}) + 1$$

If you change the step size, the number of steps changes accordingly. The sweep range remains the same.

Parameters:

<Logarithmic>	float
Range:	0.01 to 100
Increment:	1E-3
*RST:	1

Example:

```
FREQ:STAR 1GHz
sets the start frequency to 1 GHz.
FREQ:STOP 5GHz
sets the stop frequency to 5 GHz.
SWE:SPAC LOG
sets logarithmic sweep spacing.
SWE:STEP:LOG 10PCT
sets the step width for logarithmic sweep spacing to 10% of the
previous frequency in each instance (for a frequency sweep).
```

Manual operation: See "[Step Lin/Log - Frequency Sweep](#)" on page 180

[:SOURce<hw>]:SWEep:POWer:DWELI <Dwell>

Sets the time taken for each level step of the sweep.

Tip: It is recommended to switch off the "Display Update" for optimum sweep performance especially with short dwell times ([SYSTem:DISPlay:UPDate OFF](#)).

Parameters:

<Dwell>	float
Range:	1E-3 to 100
Increment:	100E-6
*RST:	15E-3

Example: `SWE:POW:DWEL 12 ms`
sets a dwell time of 12 ms for a level sweep at the RF output.

Manual operation: See "[Dwell Time - Level Sweep](#)" on page 187

[:SOURce<hw>]:SWEep:POWer:EXECute

Triggers a sweep.

The command is only valid for sweep mode Single (`SOURce:SWEep:POWer:MODE SINGLE`). The command corresponds to the manual-control command "Execute Single Sweep".

Example: `SOURce:SWEep:POWer:MODE SINGLE`
sets the single cycle mode of the level sweep.
`SWE:POW:EXEC`
triggers a level sweep at the RF output.

Usage: Event

Manual operation: See "[Execute Single Sweep - Level Sweep](#)" on page 185

[:SOURce<hw>]:SWEep:POWer:MODE <Mode>

Sets the cycle mode of the level sweep.

Parameters:

<Mode> AUTO | MANual | STEP

AUTO

Each trigger triggers exactly one complete sweep.

MANual

The trigger system is not active. Each level step of the sweep is triggered individually, either by varying the "Current Level" value using the rotary knob under manual control or by means of a `POW:MAN` command under remote control.

With manual control, the level increases or decreases (depending on the direction of the rotary encoder) by the value specified under `SOUR:SWE:POW:STEP`. With remote control, the level increases by the value specified under `SWEep:POW:STEP` which each sent `:POW:MAN` command, irrespective the value entered there.

STEP

Each trigger triggers one sweep step only. The level increases by the value entered under `:SWEep:POW:STEP`.

*RST: AUTO

Example:

`SWE:POW:MODE AUTO`

selects Mode Auto for a level sweep at RF output.

Manual operation: See "[Mode - Level Sweep](#)" on page 183

[[:SOURce<hw>]:SWEep:POWER:POINts <Points>

Determines the number of steps for the RF level sweep within the sweep range.

This parameter always applies to the currently set sweep spacing and correlates with the step size as follows:

$$\text{pow_points} = (\text{f}_{\text{STOP}} - \text{f}_{\text{START}} / \text{step_log}) + 1$$

To determine the step size use the command `SWE:POW:STEP[:LOG]`.

If you change the number of sweep points, the step size changes accordingly. The sweep range remains the same.

Parameters:

<Points> integer

Range: 2...max

Example:

`POW:STAR - 30 dBm`

sets the start frequency to -30 dBm.

`POW:STOP - 10 dBm`

sets the stop frequency to -10 dBm.

`SWE:POW:POIN 20`

sets 20 sweep steps. The sweep step width (`STEP`) is automatically set to 1 dB.

[[:SOURce<hw>]:SWEep:POWer:RETRace <State>

Activates that the signal changes to the start level value while it is waiting for the next trigger event.

You can enable this feature, when you are working with sawtooth shapes in sweep mode "Single" or "External Single".

Parameters:

<State> 0 | 1 | OFF | ON

*RST: 0

Example:

```
TRIG0:SWE:SOUR SING
```

```
POW:MODE SWE
```

```
SWE:POW:SHAP SAWT
```

```
SWE:POW:RETR ON
```

activates retrace function, i.e. the level changes to the value at start level while waiting for the next trigger event.

Manual operation: See ["Retrace - RF Level Sweep"](#) on page 186

[[:SOURce<hw>]:SWEep:POWer:RUNNing?

Queries the current state of the level sweep mode.

Return values:

<State> 0 | 1 | OFF | ON

Example:

```
SWE:POW:RUNN?
```

Response "1": signal generation in level sweep active.

Usage:

Query only

[[:SOURce<hw>]:SWEep:POWer:SHAPe <Shape>

Sets the cycle mode for a sweep sequence (shape).

Parameters:

<Shape> SAWTooth | TRIangle

SAWTooth

One sweep runs from the start level to the stop level. The subsequent sweep starts at the start level again, i.e. the shape of sweep sequence resembles a sawtooth.

TRIangle

One sweep runs from start to stop level and back, i.e. the shape of the sweep resembles a triangle. Each subsequent sweep starts at the start level again.

*RST: SAWTooth

Example:

```
SOUR:SWE:POW:SHAP TRI
```

selects the sweep cycle with alternating ascending and descending sweep directions.

Manual operation: See "Shape - RF Level Sweep" on page 186

[:SOURce<hw>]:SWEep:POWer:SPACing:MODE?

Queries the sweep spacing mode. The sweep spacing for level sweeps is always linear.

Return values:

<Mode> LINear
 *RST: LINear

Example:

SWE:POW:SPAC:MODE?
 queries the sweep spacing for a level sweep at RF output.
 Result: LIN
 linear spacing

Usage: Query only

[:SOURce<hw>]:SWEep:POWer:STEP[:LOGarithmic] <Logarithmic>

Sets a logarithmically determined sweep step size for the RF level sweep. It is expressed in decibels and you must enter the *value* and the unit *dB* with the command.

The level is increased by a logarithmically calculated fraction of the current level according to:

$$\text{step_size}_{n+1} = \text{Level}_n + \text{step_size}_n \times \text{Level}_n$$

$$\text{Level}_{n+1} = \text{Level}_n + \text{step_size}_{n+1}$$

with $\text{Level}_{\text{START}} < \text{level}_{\text{STOP}}$, $\text{step_size} = \text{SWE:POW:STEP}[:\text{LOG}]$ and $n = \text{number of sweep steps}$

This parameter correlates with the number of steps [SWE:POW:POIN](#) within the sweep range as follows:

$$\text{level_points} = ((\text{Level}_{\text{STOP}} - \text{Level}_{\text{START}}) / \text{step_size}) + 1)$$

If you change the step size, the number of steps changes accordingly. The sweep range remains the same.

Parameters:

<Logarithmic> float
 Increment: 0.01
 *RST: 1

Example:

SWE:POW:STEP 10dB
 sets the step width for logarithmic sweep spacing to 10 dB of the previous level in each instance (for a level sweep).

Manual operation: See "Step - Level Sweep" on page 187

[:SOURce<hw>]:SWEep:RESet[:ALL]

Resets all active sweeps to the starting point.

Example: SWE:RES
resets all active sweeps to the starting point.

Usage: Event

Manual operation: See "Reset Sweep - Frequency Sweep" on page 178

7.14 STATus Subsystem

This system contains the commands for the status reporting system. See also [Chapter 6.5, "Status Reporting System"](#), on page 269 for detailed information.

*RST on page 282 has no effect on the status registers.

Value ranges

- Queries return the current value of the respective register, which permits a check of the device status.
Return values: A decimal value in the range 0 to 32767 ($=2^{15}-1$)
- The configuration commands set the respective register thus determining which status changes of the R&S SMB cause the status registers to be changed.
Setting values: A decimal value in the range 0 to 32767 ($=2^{15}-1$)

:STATus:OPERation:CONDition.....	429
:STATus:OPERation:ENABle.....	430
:STATus:OPERation[:EVENT].....	430
:STATus:OPERation:NTRansition.....	430
:STATus:OPERation:PTRansition.....	430
:STATus:PRESet.....	431
:STATus:QUEStionable:CONDition.....	431
:STATus:QUEStionable:ENABle.....	431
:STATus:QUEStionable[:EVENT].....	431
:STATus:QUEStionable:NTRansition.....	432
:STATus:QUEStionable:PTRansition.....	432
:STATus:QUEue[:NEXT]?.....	432

:STATus:OPERation:CONDition <Condition>

Sets the content of the CONDition part of the STATus:OPERation register. This part contains information on the action currently being performed in the instrument. The content is not deleted after being read out because it indicates the current hardware status.

Parameters:
<Condition> string

Example: :STATus:OPERation:CONDition?
queries the Status:Operation:Condition register.

:STATus:OPERation:ENABLE <Enable>

Sets the bits of the ENABLE part of the STATus:OPERation register. This setting determines which events of the Status-Event part are forwarded to the sum bit in the status byte. These events can be used for a service request.

Parameters:

<Enable> string

Example: :STAT:OPER:ENAB 32767
all events are forwarded to the sum bit of the status byte.

:STATus:OPERation[:EVENT] <Event>

Queries the content of the EVENT part of the STATus:OPERation register. This part contains information on the actions performed in the instrument since the last readout. The content of the EVENT part is deleted after being read out.

Parameters:

<Event> string

Example: :STAT:OPER:EVEN?
queries the STATus:OPERation:EVENT register.

:STATus:OPERation:NTRansition <Ntransition>

Sets the bits of the NTRansition part of the STATus:OPERation register. If a bit is set, a transition from 1 to 0 in the condition part causes an entry to be made in the EVENT part of the register. The disappearance of an event in the hardware is thus registered, for example the end of an adjustment.

Parameters:

<Ntransition> string

Example: :STAT:OPER:NTR 0
a transition from 1 to 0 in the condition part of the Status:Operation register does not cause an entry to be made in the EVENT part.

:STATus:OPERation:PTRansition <Ptransition>

Sets the bits of the PTRansition part of the STATus:OPERation register. If a bit is set, a transition from 0 to 1 in the condition part causes an entry to be made in the EVENT part of the register. A new event in the hardware is thus registered, for example the start of an adjustment.

Parameters:

<Ptransition> string

Example: :STAT:OPER:PTR 32767
all transitions from 0 to 1 in the condition part of the Status:Operation register cause an entry to be made in the EVENT part.

:STATus:PRESet <Preset>

Resets the status registers. All PTRansition parts are set to FFFFh (32767), i.e. all transitions from 0 to 1 are detected. All NTRansition parts are set to 0, i.e. a transition from 1 to 0 in a CONDition bit is not detected. The ENABle parts of STATus:OPERation and STATus:QUEStionable are set to 0, i.e. all events in these registers are not passed on.

Parameters:

<Preset> string

Example: STAT:PRES
resets the status registers.

:STATus:QUEStionable:CONDition <Condition>

Queries the content of the CONDition part of the STATus:QUEStionable register. This part contains information on the action currently being performed in the instrument. The content is not deleted after being read out since it indicates the current hardware status.

Parameters:

<Condition> string

Example: :STATus:QUEStionable:CONDition?
queries the Status:Questionable:Condition register.

:STATus:QUEStionable:ENABle <Enable>

Sets the bits of the ENABle part of the STATus:QUEStionable register. This setting determines which events of the Status-Event part are enabled for the sum bit in the status byte. These events can be used for a service request.

Parameters:

<Enable> string

Example: STAT:OPER:ENAB 1
problems when performing an adjustment cause an entry to be made in the sum bit.

:STATus:QUEStionable[:EVENT] <Event>

Queries the content of the EVENT part of the STATus:QUEStionable register. This part contains information on the actions performed in the instrument since the last readout. The content of the EVENT part is deleted after being read out.

Parameters:

<Event> string

Example:

STAT:QUES:EVEN?

queries the Status:Questionable:Event register.

:STATus:QUESTionable:NTRansition <Ntransition>

Sets the bits of the NTRansition part of the STATus:QUESTionable register. If a bit is set, a transition from 1 to 0 in the condition part causes an entry to be made in the EVENT part of the register.

Parameters:

<Ntransition> string

Example:

STAT:OPER:NTR 0

a transition from 1 to 0 in the condition part of the Status:Questionable register does not cause an entry to be made in the EVENT part

:STATus:QUESTionable:PTRansition <PTransition>

Sets the bits of the PTRansition part of the STATus:QUESTionable register. If a bit is set, a transition from 1 to 0 in the condition part causes an entry to be made in the EVENT part of the register.

Parameters:

<PTransition> string

Example:

:STAT:OPER:PTR 32767

all transitions from 0 to 1 in the condition part of the Status:Questionable register cause an entry to be made in the EVENT part

:STATus:QUEue[:NEXT]?

Queries the oldest entry in the error queue and then deletes it. Positive error numbers denote device-specific errors, and negative error numbers denote error messages defined by SCPI. If the error queue is empty, 0 ("No error") is returned.

The command is identical to `:SYSTEM:ERROR[:NEXT]?` on page 435.

Return values:

<Next> string

Example:

:STATus:QUEue?

queries the oldest entry in the error queue.

Response: 0, 'no error'

no errors have occurred since the error queue was last read out

Usage:

Query only

Manual operation: See "History" on page 70

7.15 SYSTem Subsystem

The SYSTem subsystem contains a series of commands for general functions which do not directly affect signal generation.

:SYSTem:ERRor:ALL?	434
:SYSTem:ERRor:CODE:ALL?	434
:SYSTem:ERRor:CODE[:NEXT]?	435
:SYSTem:ERRor:COUNt?	435
:SYSTem:ERRor[:NEXT]?	435
:SYSTem:SERRor?	436
:SYSTem:DLOCK	436
:SYSTem:KLOCK	436
:SYSTem:ULOCK	437
:SYSTem:COMMunicate:GPIB:LTERminator	437
:SYSTem:COMMunicate:GPIB[:SELF]:ADDRess	438
:SYSTem:COMMunicate:NETWork[:COMMON]:DOMain	438
:SYSTem:COMMunicate:NETWork[:COMMON]:HOSTname	438
:SYSTem:COMMunicate:NETWork[:COMMON]:WORKgroup	438
:SYSTem:COMMunicate:NETWork[:IPADdress]:DNS	439
:SYSTem:COMMunicate:NETWork:IPADdress:MODE	439
:SYSTem:COMMunicate:NETWork:IPADdress	439
:SYSTem:COMMunicate:NETWork[:IPADdress]:GATeway	439
:SYSTem:COMMunicate:NETWork[:IPADdress]:SUBNet:MASK	440
:SYSTem:COMMunicate:NETWork:MACAddress	440
:SYSTem:COMMunicate:NETWork:STATus?	440
:SYSTem:COMMunicate:NETWork:REStart	440
:SYSTem:COMMunicate:GPIB:RESourcE?	441
:SYSTem:COMMunicate:NETWork:RESourcE?	441
:SYSTem:COMMunicate:HISLip:RESourcE?	441
:SYSTem:COMMunicate:USB:RESourcE?	441
:SYSTem:COMMunicate:SERial:RESourcE?	442
:SYSTem:COMMunicate:SERial:BAUD	442
:SYSTem:COMMunicate:SERial:PARity	442
:SYSTem:COMMunicate:SERial:SBITs	443
:SYSTem:COMMunicate:SOCKet:RESourcE?	443
:SYSTem:IDENtification	443
:SYSTem:LANGUage	443
:SYSTem:PROTect<ch>[:STATe]	444
:SYSTem:REBoot	444
:SYSTem:REStart	444
:SYSTem:SHUTdown	445
:SYSTem:STARtup:COMPLete?	445
:SYSTem:DISPlay:UPDate	445
:SYSTem:DATE	445
:SYSTem:HCLear	446
:SYSTem:TIME	446
:SYSTem:TIME:ZONE	446
:SYSTem:TIME:ZONE:CATalog?	446
:SYSTem:VERSIon?	447

:SYSTem:OSYStem?.....	447
:SYSTem:MMEMory:PATH:USER?.....	447
:SYSTem:WAIT.....	447

:SYSTem:ERRor:ALL?

Queries the error/event queue for all unread items and removes them from the queue. The response is a comma separated list of error number and a short description of the error in FIFO order.

Positive error numbers are instrument-dependent. Negative error numbers are reserved by the SCPI standard.

Return values:

<All> string
List of: Error/event_number,"Error/event_description">[:Device-dependent info]"
If the queue is empty, the response is 0, "No error"

Example:

SYST:ERR:ALL?
queries all entries in the error queue.
Response: 0, 'no error'
No errors have occurred since the error queue was last read out.

Usage: Query only

:SYSTem:ERRor:CODE:ALL?

Queries all entries in the error queue and then deletes them. Only the error numbers are returned and not the entire error text.

Return values:

<All> string
0
"No error", i.e. the error queue is empty
positive value
Positive error numbers denote device-specific errors
negative value
Negative error numbers denote error messages defined by SCPI.

Example:

SYST:ERR:CODE:ALL
queries all entries in the error queue.
Response: 0
no errors have occurred since the error queue was last read out.

Usage: Query only

:SYSTem:ERRor:CODE[:NEXT]?

Queries the oldest entry in the error queue and then deletes it. Only the error number is returned and not the entire error text.

Return values:

<Next> string
0
 "No error", i.e. the error queue is empty
positive value
 Positive error numbers denote device-specific errors
negative value
 Negative error numbers denote error messages defined by SCPI.

Example:

SYST:ERR:CODE
 queries the oldest entry in the error queue.
 Response: 0
 No errors have occurred since the error queue was last read out.

Usage: Query only

:SYSTem:ERRor:COUNT?

Queries the number of entries in the error queue. If the error queue is empty, '0' is returned.

Return values:

<Count> string

Example:

SYST:ERR:COUN
 queries the number of entries in the error queue.
 Response: 1
 One error has occurred since the error queue was last read out.

Usage: Query only

:SYSTem:ERRor[:NEXT]?

Queries the error/event queue for the oldest item and removes it from the queue. The response consists of an error number and a short description of the error.

Positive error numbers are instrument-dependent. Negative error numbers are reserved by the SCPI standard.

Return values:

<Next> string
 Error/event_number,"Error/event_description>[:Device-dependent info]"
 If the queue is empty, the response is 0, "No error"

Example: SYST:ERR?
 queries the oldest entry in the error queue.
 Response: 0, 'no error'
 No errors have occurred since the error queue was last read out.

Usage: Query only

Manual operation: See "[History](#)" on page 70

:SYSTem:SERRor?

This command returns a list of all errors existing at the time when the query is started. This list corresponds to the display on the info page under manual control.

Return values:

<StaticErrors> string

Example: SYSTem:SERRor?
 queries all errors existing in the error queue.
 Response: -221, 'Settings conflict', 153,
 'Input voltage out of range'
 the two returned errors have occurred since the error queue was last queried.

Usage: Query only

:SYSTem:DLOCK <DispLockStat>

Disables the display, or enables it again (OFF).

The command disables also the front panel keyboard of the instrument including the LOCAL key.

Parameters:

<DispLockStat> 0 | 1 | OFF | ON
 *RST: 0

Example: SYST:DLOC ON
 locks the display. To unlock the display SYST:DLOC OFF.

Manual operation: See "[User Interface](#)" on page 118

:SYSTem:KLOCK <State>

Keyboard **LOCK** disables the front panel keyboard of the instrument including the LOCAL key, or enables it again (OFF).

The command disables also the front panel keyboard of the instrument including the LOCAL key.

Parameters:

<State> 0 | 1 | OFF | ON
 *RST: 0

Example: `SYST:KLOC ON`
locks the front panel and external controls. To enable the controls, set `SYST:KLOC OFF`.

Manual operation: See "[User Interface](#)" on page 118

:SYSTem:ULOCK <Mode>

Locks or unlocks the user interface of the instrument.

Parameters:

<Mode> ENABled | DONLy | DISabled

ENABled

Unlocks the display and all controls for the manual operation.

DONLy

Locks the controls for the manual operation of the instrument. The display shows the current settings.

DISabled

Locks the controls for the manual operation, and enables remote operation over VNC. The display shows the current settings.

*RST: ENABled

Example: `SYST:ULOC ON`
activates the user interface lock.

Manual operation: See "[User Interface](#)" on page 118

:SYSTem:COMMunicate:GPIB:LTERminator <LTerminator>

Sets the terminator recognition for remote control via GPIB bus.

Parameters:

<LTerminator> STANdard | EOI

EOI

The terminator must be sent together with the line message EOI (End of Line). This setting is recommended for binary block transmissions where a character could coincidentally have the value LF (Line Feed) but is not intended as the terminator. This setting must be selected for block data with undefined length.

STANdard

An LF (Line Feed) is recognized as the terminator regardless of whether it is sent with or without EOI.

*RST: STANdard

Example: `SYSTem:COMMunicate:GPIB:LTERminator EOI`
only a character which is sent simultaneously with the line message EOI is accepted as the terminator.

:SYSTem:COMMunicate:GPIB[:SELF]:ADDRESS <Address>

Sets the GPIB address.

Parameters:

<Address> integer
 Range: 1 to 30
 *RST: 28

Example: SYSTem:COMMunicate:GPIB:SELF:ADDRESS 28
 sets GPIB address.

Manual operation: See "[GPIB channel address](#)" on page 109

:SYSTem:COMMunicate:NETWork[:COMMON]:DOMain <Domain>

Sets the primary suffix, that is the DNS name without the host name part.

Parameters:

<Domain> string

Example: SYSTem:COMMunicate:NETWork:COMMON:DOMain
 'ABC.DE'
 sets the domain of the network.

Manual operation: See "[DNS Suffix](#)" on page 106

:SYSTem:COMMunicate:NETWork[:COMMON]:HOSTname <Hostname>

Sets the individual host name of the R&S SMB.

Note: it is recommended that you do not change the host name in order to avoid problems with the network connection. However, if you change the host name be sure to use an unique name.

The host name is a protected parameter, To change it, first disable protection level 1 with command `:SYSTem:PROTect<ch>[:STATe]` on page 444.

Parameters:

<Hostname> string

Example: SYSTem:PROTect1:STATe OFF,123456
 SYSTem:COMMunicate:NETWork:HOSTname 'SIGGEN'
 sets the individual computer name of the R&S SMB.

Manual operation: See "[Hostname](#)" on page 105

:SYSTem:COMMunicate:NETWork[:COMMON]:WORKgroup <Workgroup>

Sets the individual workgroup name of the instrument.

Parameters:

<Workgroup> string

Example: `SYSTEM:COMMunicate:NETWork:COMMON:WORKgroup`
 `'TEST_09'`
 sets the workgroup name

Manual operation: See "[Workgroup](#)" on page 105

:SYSTEM:COMMunicate:NETWork[:IPAddress]:DNS <DNS>

Determines the net DNS server to resolve the name.

Parameters:

<DNS> string

Example: `SYST:COMM:NETW:IPAD:DNS 123.456.0.1`

Manual operation: See "[DNS Server](#)" on page 107

:SYSTEM:COMMunicate:NETWork:IPAddress:MODE <Mode>

Selects manual or automatic setting of the IP address.

Parameters:

<Mode> AUTO | STATic
 *RST: AUTO

Example: `SYSTEM:COMMunicate:NETWork:IPAddress:MODE AUTO`
 the IP address is assigned automatically (DHCP)

Manual operation: See "[Address Mode](#)" on page 106

:SYSTEM:COMMunicate:NETWork:IPAddress <IpAddress>

Sets the IP address.

Parameters:

<IpAddress> string
 Range: 0.0.0.0. to ff.ff.ff.ff

Example: `SYSTEM:COMMunicate:NETWork:IPAddress '7.8.9.10'`
 sets the IP address of the instrument.

Manual operation: See "[IP Address](#)" on page 106

:SYSTEM:COMMunicate:NETWork[:IPAddress]:GATeway <Gateway>

Sets the IP address of the default gateway.

Parameters:

<Gateway> string
 Range: 0.0.0.0 to ff.ff.ff.ff

Example: `SYSTem:COMMunicate:NETWork:IPAdDress:GATeway
'1.2.3.4'`
sets the IP address of the default gateway.

Manual operation: See ["Default Gateway"](#) on page 106

:SYSTem:COMMunicate:NETWork[:IPAdDress]:SUBNet:MASK <Mask>

Sets the subnet mask.

Parameters:

<Mask> string

Example: `SYSTem:COMMunicate:NETWork:IPAdDress:SUBNet:
MASK '255.255.0.0'`
determines the subnet mask.

Manual operation: See ["Subnet Mask"](#) on page 106

:SYSTem:COMMunicate:NETWork:MACAdDress <MacAddress>

Queries the MAC address of the network adapter.

Parameters:

<MacAddress> string

Example: `SYST:COMM:NETW:MAC`
queries the MAC address.

Manual operation: See ["MAC Address"](#) on page 107

:SYSTem:COMMunicate:NETWork:STATus?

Queries the network configuration state.

Return values:

<State> 0 | 1 | OFF | ON

Usage: Query only

Manual operation: See ["Network Status"](#) on page 105

:SYSTem:COMMunicate:NETWork:REStArt

Restarts the network connection to the instrument, terminates the connection and sets it up again.

Example: `SYSTem:COMMunicate:NETWork:REStArt`

Usage: Event

Manual operation: See ["Restart Network"](#) on page 107

:SYSTEM:COMMunicate:GPIB:RESource?

Queries the visa resource string for remote control via the GPIB interface.

To change the GPIB address, use the command `:SYSTEM:COMMunicate:GPIB[:SELF] :ADDRESS`.

Return values:

<Resource> string

Example:

```
SYSTEM:COMMunicate:GPIB:RESource?  
queries the VISA resource string.  
Response: "GPIB::28::INSTR"
```

Usage: Query only

Manual operation: See "[Visa Resource Strings](#)" on page 110

:SYSTEM:COMMunicate:NETWork:RESource?

Queries the VISA resource string, used for remote control of the instrument with VXI-11 protocol.

Return values:

<Resource> string

Example:

```
SYSTEM:COMMunicate:NETWork:RESource?  
Response: "TCPIP::192.1.2.3::INSTR"
```

Usage: Query only

Manual operation: See "[Visa Resource Strings](#)" on page 110

:SYSTEM:COMMunicate:HISLip:RESource?

Queries the VISA resource string, used for remote control of the instrument with HiSLIP protocol.

Return values:

<Resource> string

Example:

```
SYSTEM:COMMunicate:HISLip:RESource?  
Response: "TCPIP::192.1.2.3::hislip0::INSTR"
```

Usage: Query only

Manual operation: See "[Visa Resource Strings](#)" on page 110

:SYSTEM:COMMunicate:USB:RESource?

Queries the visa resource string for remote control via the USB interface.

Return values:

<Resource> string

Example: `SYSTem:COMMunicate:USB:RESource?`
 queries the VISA resource string for remote control via the USB interface.
 Response: "USB::72::000000::INSTR"

Usage: Query only

Manual operation: See "[Visa Resource Strings](#)" on page 110

:SYSTem:COMMunicate:SERial:RESource?

Queries the visa resource string for the serial remote control interface. This string is used for remote control of the instrument.

Return values:

<Resource> string

Example: `SYSTem:COMMunicate:SERial:RESource?`
 queries the VISA resource string.
 Response: "ASRL1::INSTR"

Usage: Query only

Manual operation: See "[Visa Resource Strings](#)" on page 110

:SYSTem:COMMunicate:SERial:BAUD <Baud>

Sets the baudrate for the serial remote control interface.

Parameters:

<Baud> 2400 | 4800 | 9600 | 19200 | 38400 | 57600 | 115200
 *RST: 115200

Example: `SYSTem:COMMunicate:SERial:BAUD 115200`
 determines 115200 baudrate.

Manual operation: See "[Baud Rate](#)" on page 109

:SYSTem:COMMunicate:SERial:PARity <Parity>

Sets the parity for the serial remote control interface.

Parameters:

<Parity> NONE | ODD | EVEN
 *RST: NONE

Example: `SYST:COMM:SER:PAR NONE`
 selects parity NONE.

Manual operation: See "[Parity](#)" on page 109

:SYSTem:COMMunicate:SERial:SBITs <SBits>

Sets the number of stop bits for the serial remote control interface.

Parameters:

<SBits> 1 | 2
*RST: 1

Example: SYST:COMM:SER:SBIT 2
 selects 2 stop bits.

Manual operation: See "[Stop Bits](#)" on page 110

:SYSTem:COMMunicate:SOCKet:RESource?

Queries the visa resource string for remote control via LAN interface, using TCP/IP socket protocol.

Return values:

<Resource> string

Example: SYSTem:COMMunicate:SOCKet:RESource?
 Response: "TCPIP::10.113.1.150::5025::SOCKET"

Usage: Query only

Manual operation: See "[Visa Resource Strings](#)" on page 110

:SYSTem:IDENtification <Identification>

Selects the mode the instrument identification is performed.

Parameters:

<Identification> AUTO | USER
AUTO
The "IDN String" and the "OPT String" are set automatically.
USER
Enables the selection of user definable "IDN String" and "OPT String".
*RST: AUTO

Example: SYST:IDEN USER
 selects the user defined identification string.

Manual operation: See "[Mode](#)" on page 111

:SYSTem:LANGuage <Language>

Sets the remote control command set.

The instrument can also be remote controlled via the command set of several other generators, for example HP generator. See the Application Note [1GP71](#) at the download area of the product site on the Internet.

Note: While working in a emulation mode, the instrument's specific command set is disabled, i.e. the SCPI command `SYSTem:LANGuage` will be discarded.

The return to the SCPI command set of the R&S SMB can only be performed by using the appropriate command of the selected command set. For example, the HP command `EX` returns to the instrument-specific GPIB command set (selection `SYST:LANG 'HPxxxx'`).

Parameters:

<Language> string

Example:

`SYSTem:LANGuage "SCPI"`
sets the SCPI command set.

Manual operation: See "[Language](#)" on page 111

:SYSTem:PROTect<ch>[:STATe] <State>[, <Key>]

Activates/deactivates the specified protection level.

Parameters:

<State> select
 *RST: 1

Setting parameters:

<Key> integer

The respective functions are disabled when the protection level is activated. No password is required for activation. A password must be entered to deactivate the protection level. The password for the first level is 123456.

This protection level can be used to lock-out internal adjustments.

Example:

`SYSTem:PROTect1:STATe ON`
activates protection level 1. Internal adjustments are only possible after deactivating the lock-out.
`SYSTem:PROTect1:STATe OFF,123456`
deactivates protection level 1. Internal adjustments are enabled again.

Manual operation: See "[Protection Level/Password](#)" on page 114

:SYSTem:REBoot

Restarts the firmware and the operating system.

Usage: Event

:SYSTem:REStArt

Restarts the firmware. The operating system remains active.

Usage: Event

:SYSTem:SHUTdown

Shuts down the instrument.

Usage: Event

:SYSTem:STARtup:COMPLete?

Queries if the startup of the instrument is completed.

Return values:

<Complete> 0 | 1 | OFF | ON
*RST: 0

Example: SYST:STAR:COMP
Response: 1
The startup of the instrument is completed.

Usage: Query only

:SYSTem:DISPlay:UPDate <Update>

Switches the update of the display on/off. A switchover from remote control to manual control always sets the status of the update of the display to ON.

Parameters:

<Update> 0 | 1 | OFF | ON
*RST: ON

Example: SYST:DISP:UPD OFF
switches update of displayed parameter values off.

Manual operation: See "[Display Update is On/Off](#)" on page 100

:SYSTem:DATE <Year>, <Month>, <Day>

Queries or sets the date for the instrument-internal calendar.

This parameter is protected, in order to prevent accidental changes.

It can be accessed with protection level 1, see [:SYSTem:PROTeCt<ch>\[:STATe\]](#) on page 444.

Parameters:

<Year> <year>,<month>,<day>
<Month> integer
Range: 1 to 12
<Day> integer
Range: 1 to 31

Example: SYST:DATE?
 Response: "2011, 05, 01"
 it is the 1st of May, 2011.

Manual operation: See "[Date](#)" on page 103

:SYSTEM:HCLear

Clears the history.

Example: SYST:HCL
 Deletes the history entries.

Usage: Event

:SYSTEM:TIME <Hour>, <Minute>, <Second>

Queries or sets the time for the instrument-internal clock.

The parameter is protected, in order to prevent accidental changes.

It can be accessed with protection level 1, see [:SYSTEM:PROTECT<ch>\[:STATE\]](#) on page 444.

Parameters:

<Hour>	0...23,0...59,0...59
	Range: 0 to 23
<Minute>	integer
	Range: 0 to 59
<Second>	integer
	Range: 0 to 59

Example: SYSTEM:TIME?
 Response: "12, 0, 0" it is precisely 12 pm.

Manual operation: See "[Time](#)" on page 103

:SYSTEM:TIME:ZONE <TimeZone>

Sets the time zone. You can query the list of the available time zones with [:SYSTEM:TIME:ZONE:CATALOG?](#).

Parameters:

<TimeZone>	string
------------	--------

Manual operation: See "[Time Zone](#)" on page 104

:SYSTEM:TIME:ZONE:CATALOG?

Queries the list of available time zones.

Return values:

<Catalog>

Usage: Query only**Manual operation:** See "Time Zone" on page 104**:SYSTem:VERSion?**

Queries the SCPI version the instrument's command set complies with.

Return values:

<Version> string

Example:

SYST:VERS

queries the SCPI version.

Response: "1996"

The instrument complies with the SCPI version from 1996.

Usage: Query only**:SYSTem:OSYStem?**

Queries the operating system of the instrument.

Return values:

<OperSystem> string

Example:

SYSTem:OSYStem?

Response: "Linux"

Usage: Query only**:SYSTem:MMEMory:PATH:USER?**

Queries the user directory, that means the directory the instrument stores user files on.

Return values:

<PathUser> string

Example:

SYSTem:MMEMory:PATH:USER?

Response: "/var/user/"

Usage: Query only**:SYSTem:WAIT <TimeMs>**

Delays the execution of the subsequent remote command by the specified time.

This function is useful, for example to execute an SCPI sequence automatically but with a defined time delay between some commands.

Setting parameters:

<TimeMs> integer
 Wait time in ms
 Range: 0 to 10000
 *RST: 0

Example:

```
:SYSTem:WAIT 10000
// waits 10s before resetting the instrument
*RST
```

Usage: Setting only

7.16 TEST Subsystem

The TEST system contains the commands for performing selftest routines, and for direct adjustment of the hardware assemblies (:TEST:DIReCt).

The self tests return a "0" if the test is performed successfully, otherwise a value other than "0" is returned. None of the commands of this system have an *RST value.

NOTICE

Improper use can destroy the assembly

The respective hardware assembly responds directly to the :TEST:DIReCt command; any safety mechanisms are bypassed. The command is intended for servicing purposes and should be used only by the Rohde & Schwarz service personnel.

:TEST<hw>:ALL:START.....	448
:TEST<hw>:ALL:RESult?.....	448
:TEST<hw>:DIReCt.....	449

:TEST<hw>:ALL:START

Starts a self-test on all installed hardware options.

To query the result, use the command :TEST<hw>:ALL:RESult? on page 448.

Example: See :TEST<hw>:ALL:RESult? on page 448

Usage: Event

Manual operation: See "Start Selftest" on page 101

:TEST<hw>:ALL:RESult?

Queries the result of the performed self-test (command :TEST<hw>:ALL:START on page 448).

Return values:

<Result> 0 | 1 | RUNning | STOPped
0
 Success
1
 Fail
 *RST: STOPped

Example:

```
TEST:ALL:STAR
Starts the self-test
TEST:ALL:RES?
```

Usage:

Query only

Manual operation: See "Start Selftest" on page 101

```
:TEST<hw>:DIRect <HW_assembly>,<subaddress>,<hex data string>
:TEST<hw>:DIRect? <HW_assembly>,<subaddress>
```

The respective hardware assembly responds directly to the command; any safety mechanisms are bypassed. This function is only available via remote control.

Example:

```
TEST:DIR 'SSYN',0,#H12345678
TEST:DIR? 'SSYN',0
Response: #H12345678
```

7.17 TRIGger Subsystem

The TRIGger system contains the commands for selecting the trigger source for the RF and LF sweep. The trigger input connectors are configured in the SOURCE:INPut subsystem.

The trigger system of the R&S SMB is a simplified implementation of the SCPI trigger system. The TRIGger system differs from the SCPI system as follows:

- No INITiate command; the instrument behaves as if INITiate:CONTinuous ON were set.
- Under TRIGger several sweep subsystems exist.

Other commands associated with the trigger system of the R&S SMB can be found in the modulation and RF signal subsystems.

TRIGger<hw>

- Suffix TRIGger<1|2> is not permitted
- TRIGger0 activates the LF output.

Table 7-2: Cross-reference between the manual and remote control

R&S name	SCPI name	Command under manual control
AUTO	IMMEDIATE	"Auto" mode
SINGLE	BUS	"Single" mode.
EXTERNAL	EXTERNAL	"Ext Single" and "Ext Step" mode. Use command <code>LFO:SWEep:MODE</code> to select between the two sweep modes.
EAuto	-	"Ext Start/Stop" mode.

<code>:TRIGger<hw>:FSweep:SOURce</code>	450
<code>:TRIGger<hw>:FSweep[:IMMEDIATE]</code>	451
<code>:TRIGger<hw>:LFFSweep</code>	452
<code>:TRIGger<hw>:LFFSweep:SOURce</code>	452
<code>:TRIGger<hw>:LFFSweep:IMMEDIATE</code>	452
<code>:TRIGger<hw>:PSweep:SOURce</code>	453
<code>:TRIGger<hw>:PSweep[:IMMEDIATE]</code>	453
<code>:TRIGger<hw>[:SWEep]:SOURce</code>	454
<code>:TRIGger<hw>[:SWEep][:IMMEDIATE]</code>	455
<code>:TRIGger<hw>[:IMMEDIATE]</code>	455

`:TRIGger<hw>:FSweep:SOURce` <Source>

Sets the trigger source for the RF frequency sweep.

The names of the parameters correspond directly to the various settings under manual control. SCPI uses other names for the parameters; these names are also accepted by the instrument. The SCPI names should be used if compatibility is an important consideration.

An overview of the various names is given in [Table 7-2](#).

Parameters:

<Source>

AUTO | IMMEDIATE | SINGLE | BUS | EXTERNAL | EAUTO

AUTO|IMMEDIATE

The trigger is free-running, i.e. the trigger condition is fulfilled continuously. As soon as one sweep is finished, the next sweep is started.

SINGLE|BUS

One complete sweep cycle is triggered by the GPIB commands `[:SOURCE<hw>] :SWEep [:FREQuency] :EXECute, : TRIGger<hw> :FSWeep [:IMMEDIATE]` or `*TRG`. The mode has to be set to AUTO (`:SOURCE :SWEep :FREQuency :MODE AUTO`).

EXTERNAL

The sweep is triggered externally via the INST TRIG connector.

EAUTO

The sweep is triggered externally via the INST TRIG connector. As soon as one sweep is finished, the next sweep is started. A second trigger event stops the sweep at the current frequency, a third trigger event starts the trigger at the start frequency, and so on.

```
*RST:      AUTO
```

Example:

```
TRIG:FSW:SOUR EXT
```

selects triggering with an external trigger.

Manual operation: See "Mode - RF Frequency Sweep" on page 176

:TRIGger<hw>:FSWeep[:IMMEDIATE]

Immediately starts an RF frequency sweep cycle.

The command is only effective for sweep mode "Single" (`SOUR :SWE :FREQ :MODE AUTO` in combination with `TRIG :FSW :SOUR SING`).

The command corresponds to the manual control "Execute Single Sweep".

Example:

```
SWE:FREQ:MODE AUTO
```

sets the triggered sweep mode, i.e. a trigger is required to start the sweep.

```
TRIG:FSW:SOUR SING
```

sets the "Single" trigger mode, i.e. a trigger starts a single sweep.

```
TRIG:FSW
```

starts a single RF frequency sweep.

Usage:

Event

Manual operation: See "Execute Single Sweep - Frequency Sweep" on page 178

:TRIGger<hw>:LFFSweep**Usage:** Event**Manual operation:** See "Execute Single Sweep" on page 223

Immediately starts an LF frequency sweep.

The command is effective in sweep mode "Single" (LFO:SWE:MODE AUTO in combination with TRIG:LFFS:SOUR SING).

:TRIGger<hw>:LFFSweep:SOURce <Source>

Sets the trigger source for the LF sweep. The trigger is triggered by the command :SOURce:LFOuTput:SWEep[:FREQuency] EXECute.

The names of the parameters correspond directly to the various settings under manual control. SCPI uses other names for the parameters; these names are also accepted by the instrument. The SCPI names should be used if compatibility is an important consideration.

An overview of the various names is given in the [Table 7-2](#).**Parameters:**

<Source>

AUTO | IMMEDIATE | SINGLE | BUS | EXTERNAL | EAUTO

AUTO|IMMEDIATE

The trigger is free-running, i.e. the trigger condition is fulfilled continuously. As soon as one sweep is finished, the next sweep is started.

SINGLE|BUS

One complete sweep cycle is triggered by the GPIB commands [:SOURce<hw>]:LFOuTput:SWEep[:FREQuency]: EXECute or *TRG.

The mode has to be set to AUTO ([:SOURce<hw>]:LFOuTput:SWEep[:FREQuency]:MODE).

EXTERNAL

The sweep is triggered externally via the INST TRIG connector.

EAUTO

The sweep is triggered externally via the INST TRIG connector. As soon as one sweep is finished, the next sweep is started. A second trigger event stops the sweep at the current frequency, a third trigger event starts the trigger at the start frequency, and so on.

*RST: AUTO

Example:

TRIG:LFFS:SOUR EXT

selects triggering with an external trigger.

:TRIGger<hw>:LFFSweep:IMMEDIATE

Immediately starts an LF frequency sweep.

The command is effective in sweep mode "Single" (LFO:SWE:MODE AUTO in combination with TRIG:LFFS:SOUR SING).

Usage: Event

Manual operation: See "Execute Single Sweep" on page 223

:TRIGger<hw>:PSWeep:SOURce <Source>

Sets the trigger source for the RF level sweep.

The names of the parameters correspond directly to the various settings under manual control. SCPI uses other names for the parameters; these names are also accepted by the instrument. The SCPI names should be used if compatibility is an important consideration.

An overview of the various names is given in [Table 7-2](#).

Parameters:

<Source> AUTO | IMMEDIATE | SINGLE | BUS | EXTERNAL | EAUTO

AUTO|IMMEDIATE

The trigger is free-running, i.e. the trigger condition is fulfilled continuously. As soon as one sweep is finished, the next sweep is started.

SINGLE|BUS

One complete sweep cycle is triggered by the GPIB commands [:SOURce<hw>] :SWEep:POWer:EXECute, :TRIGger<hw>:PSWeep [:IMMEDIATE] or *TRG. The mode has to be set to AUTO (:SOURce:SWEep:LEVel:MODE AUTO).

EXTERNAL

The sweep is triggered externally via the INST TRIG connector.

EAUTO

The sweep is triggered externally via the INST TRIG connector. As soon as one sweep is finished, the next sweep is started. A second trigger event stops the sweep at the current frequency, a third trigger event starts the trigger at the start frequency, and so on.

*RST: AUTO

Example: TRIG:PSW:SOUR EXT
selects triggering with an external trigger.

Manual operation: See "Mode - Level Sweep" on page 183

:TRIGger<hw>:PSWeep[:IMMEDIATE]

Immediately starts an RF level sweep.

The command is only effective for sweep mode "Single" (SOURce:SWEep:POWer:MODE AUTO in combination with TRIG:PSW:SOUR SING).

The command corresponds to the manual control "Execute Single Sweep".

- Example:** `SWE:POW:MODE AUTO`
selects the triggered sweep mode, i.e. a trigger is required to start the sweep.
- `TRIG:PSW:SOUR SING`
sets the single trigger mode, i.e. a trigger starts a single sweep.
- `TRIG:PSW`
starts a single RF level sweep.
- Usage:** Event
- Manual operation:** See "[Execute Single Sweep - Level Sweep](#)" on page 185

:TRIGger<hw>[:SWEep]:SOURce <Source>

The command sets the trigger source for all sweeps.

The names of the parameters correspond directly to the various settings under manual control. SCPI uses other names for the parameters; these names are also accepted by the instrument. The SCPI names should be used if compatibility is an important consideration.

An overview of the various names is given in the [Table 7-2](#).

Setting parameters:

- <Source>** AUTO | IMMEDIATE | SINGLE | BUS | EXTERNAL | EAUTO
- AUTO|IMMEDIATE**
The trigger is free-running, i.e. the trigger condition is fulfilled continuously. As soon as one sweep is finished, the next sweep is started.
- SINGLE|BUS**
One complete sweep cycle is triggered by the GPIB commands `:SOURce:SWEep:POWer|FREQuency:EXEC`, `TRIGger:PSWEEP|FSWEEP:IMMEDIATE` or `*TRG`.
If `:SOURce:SWEep:POWer:MODE` is set to `STEP`, one step is executed.
The mode has to be set to `AUTO`.
- EXTERNAL**
The sweep is triggered externally via the INST TRIG connector.
- EAUTO**
The sweep is triggered externally via the INST TRIG connector. As soon as one sweep is finished, the next sweep is started. A second trigger event stops the sweep at the current frequency, a third trigger event starts the trigger at the start frequency, and so on.
- `*RST: AUTO`

- Example:** `TRIG0:SOUR EXT`
selects triggering with an external trigger. The trigger is input via the INST TRIG connector.
- Usage:** Setting only

Manual operation: See ["Mode"](#) on page 221

:TRIGger<hw>[:SWEep][:IMMEDIATE]

Starts all sweeps which are activated for the respective path. The command starts all sweeps which are activated.

The sweep to be executed depends on the respective MODE setting
(:SOUR:SWEep:POW | FREQ:MODE and :SOUR:LFO:SWEep [:FREQ] :MODE).

The command corresponds to the manual-control command "Execute Trigger".

Example: TRIG
starts all active sweeps.

Usage: Event

Manual operation: See ["Execute Single Sweep - Frequency Sweep"](#) on page 178

:TRIGger<hw>[:IMMEDIATE]

The command immediately starts the activated sweep.

The command performs a single sweep and therefore applies to sweep mode AUTO with sweep source SINGle. Use the commands

TRIG:FSW|LFFS|PSW [:SWE] :SOUR SING, and SOUR:SWE:FREQ|POW:MODE, or SOUR:LFO:SWE: [FREQ:] MODE to set the respective single sweep. You can alternatively use an IMMEDIATE command instead of the respective SWEep: [FREQ:] | POW:EXECute command.

Example: TRIG
starts all active sweeps.

Usage: Event

Manual operation: See ["Execute Single Sweep"](#) on page 223

7.18 UNIT Subsystem

The UNIT subsystem contains the commands specifying which units are valid if no unit is indicated in a command. These settings are valid for the entire instrument.

:UNIT:ANGLE <Angle>

Defines the default unit for the phase modulation angle. It is not valid for commands which determine angle values, e.g. RF phase. It does not influence the manual control parameter unit and the display.

Parameters:

<Angle> DEGRee | RADian
*RST: RADian

Example: `UNIT:ANGL DEG`
sets DEG as a default unit for all commands which determine angle values.

:UNIT:POWer <Power>

Defines the default unit for power parameters. This setting affects the GUI, as well as all remote control commands that determine power values.

Parameters:

<Power> `V | DBUV | DBM`
`*RST: DBM`

Example: `UNIT:POW V`
sets V as a default unit for all commands which determine power values.

7.19 Direct Commands for the Stereo/RDS Coder Option R&S SMB-B5

The direct command allow to access all functions of the stereo coder option.

Some of the functions are also available via SCPI commands. In this case, it is recommended to use the SCPI commands in order to keep the settings of the R&S SMB and the stereo coder synchronized. Direct command for which a SCPI command is available are marked with “for documentation reasons only” and the SCPI command is given.

The direct commands are sent to the Stereo/RDS Coder with
`[SOURce:]STEReo:DIRect "command string".`

Information is queried with `STEReo:DIRect? "command string".`

All parameters are string parameters, this is the reason why all of them have to be sent in qotation marks (" – characters are part of the full direct command !).

Prior to using the stereo coder, the stereo modulation of the R&S SMB has to be switched on with command `SOURce:STEReo:STATe ON`. The SCPI command `SOURce:STEReo:AUDio:FREQuency` sets the LF-Generator frequency and command `SOURce:STEReo:MMF` limits the modulation frequency. These commands have no counterpart in the direct commands.

7.19.1 Remote-Control Commands

STEReo:DIRect "<FFG>=<RetrNumb>,<DataSeq#1>,<DataSeq#2>,..."
STEReo:DIRect? "<FFG>"

Transmits data via free format groups (FFGs). A free format group can be filled with any desired data. (5 bits in block B and 16 bits each in blocks C and D of the group).

Note: The command described here only causes a queue to be filled with data for a specific group. The data will only be sent when the group in question is added to the group sequence with the command "[GS](#)", on page 465.

Setting parameters:

<RetrNumb> Number of retransmissions

<DataSeq> Max. 20 different data sequences can be defined.
10 characters must be specified each per <DataSeq>. Leading zeros, if any, must also be specified.
00: erases the data.
Range: 0000000000 to 1FFFFFFFFF (10 ASCII coded hexadecimal characters each)

Parameters for setting and query:

<FFG> 1A | 3A | 5A | 6A | 7A | 8A | 9A | 10A | 11A | 12A | 13A
Determines the free format group.
To transmit the FFGs of the B group, the same commands are used, only the A groups are replaced by the B groups in the group sequence. If B groups are transmitted, block C is overwritten with the PI code.

Example: STEReo:DIRect "1A=01,0123456789,1FFFFFFFFF"
Fills a queue with the data "0123456789,1FFFFFFFFF". The data is sent in consecutive order in group 1A after group 1A is added to the group sequence (see command "[GS](#)", on page 465).

Example: STEReo:DIRect? "1A"
Reads the data of group 1A.
Response: "01,0123456789,1FFFFFFFFF"

STEReo:DIRect "AF=<A>,<Freq#1>,<Freq#2>,..."

STEReo:DIRect? "AF<z>"

Defines an alternative frequency list.

Note: A maximum of five AF lists with max. 25 frequencies per list can be created.

Parameters:

<Freq> xxx.x
Sets the alternative frequencies as ASCII coded decimal numbers.
If list <z> is not available, the response is ().
Range: 87.6 to 107.9

Setting parameters:

<A> **N**
new AF list
+
AF list to be added

Query parameters:

<z> AF list to be read
Range: 1 to 5

Example: STEReo:DIRect "AF=N,97.4,98.3"
Defines an alternative frequency list, the alternative frequencies 97.4 and 98.3 are inserted.

Example: STEReo:DIRect? "AF1"
Reads the first alternative frequency list.
Response: "97.4,98.3"

Example: STEReo:DIRect "AF=N"
Deletes all frequency lists.

STEReo:DIRect "ARI=<State>"

STEReo:DIRect? "ARI"

(for documentation reasons only)

Activates ARI signal transmission.

Use SCPI command [:SOURce]:STEReo:ARI:STATe instead.

Setting parameters:

<State> 0 | 1

Example: STEReo:DIRect "ARI=0"
Deactivates ARI signal transmission.

Example: STEReo:DIRect? "ARI"
Response: "0"

STEReo:DIRect "ARI-DEV=<Deviation>"

STEReo:DIRect? "ARI-DEV"

(for documentation reasons only)

Sets the frequency deviation of the ARI signal (max. deviation).

Use SCPI command [:SOURce]:STEReo:ARI[:DEViation] instead.

Setting parameters:

<Deviation> Sets the frequency deviation.
Note: A four-digit value must always be set. Leading zeros, if any, must also be specified.
Range: 0000 to 1000 (ASCII coded decimal numbers),
corresponding to 0 Hz to 10 kHz

Example: STEReo:DIRect "ARI-DEV=1000"
Sets the ARI frequency deviation to 10 kHz.

Example: STEReo:DIRect? "ARI-DEV"
Response: "1000"

STEReo:DIRect "ARI-ID=<Id>"

STEReo:DIRect? "ARI-ID"

(for documentation reasons only)

Selects the ARI identification.

Use SCPI command [:SOURce] :STEReo:ARI:TYPE instead.

Parameters:

<Id>	0 1 2 3
0	Off
1	DK (traffic announcement identification)
2	BK (area identification)
3	DK and BK (traffic announcement identification and area identification)

Example: STEReo:DIRect "ARI-ID=0"
Deactivates the ARI identification.

Example: STEReo:DIRect? "ARI-ID"
Response: "0"

STEReo:DIRect "BIN=<x>"

Defines and sends, or queries, binary test patterns. The BIN command causes the Stereo/RDS Coder to send periodic binary bit patterns instead of RDS data.

Parameters:

<x>	0 binary mode OFF
	1 00000000...,
	2 11111111...,
	3 01010101...,
	4 11001100...

Example: STEReo:DIRect "BIN=2"
The binary test pattern is set to "2" so that only "1s" are transmitted.

STEReo:DIRect "BK=<Code>"

STEReo:DIRect? "BK"

(for documentation reasons only)

Sets the ARI area identification.

Use SCPI command `[:SOURce] :STEReo:ARI: BK [:CODE]` instead.

Parameters:

<Code> A | B | C | D | E | F

Example:

`STEReo:DIRect "BK=E"`

The ARI area identification is set to "E".

Example:

`STEReo:DIRect? "BK"`

Response: "E"

STEReo:DIRect "CT= <Hour>:<Min>:<Sec>,<Day>.<Month>.<Year>"

STEReo:DIRect? "CT"

Sets and activates transmission of the real-time clock.

Note: The CT data is transmitted in group 4A. Setting the real-time clock (CT command) automatically adds group 4A to the group sequence. Group 4A must not be manually added to, or removed from, the group sequence. To remove group 4A from the group sequence, use the command "**CT=off**".

Setting parameters:

<Hour>:<Min>:<Sec> Range: 00:00:00 to 23:59:59

<Day>.<Month>.<Year> Range: 01.01.00 to 31.12.85

Example:

`STEReo:DIRect "CT=20:30:59,01.08.03"`

The real-time clock is set to 20:30:59 and 1 August 2003.

Example:

`STEReo:DIRect? "CT"`

Response: "20:31:06,01.08.03"

STEReo:DIRect "CT=off"

Deactivates transmission of the real-time clock signal in the RDS signal.

Note: This command is used to remove group 4A from the group sequence. Group 4A must not be manually removed from the group sequence.

Example:

`STEReo:DIRect "CT=off"`

The real-time clock signal is no longer transmitted in the RDS signal.

Usage:

Setting only

STEReo:DIRect "DI=<x>"

STEReo:DIRect? "DI"

Sets or reads the decoder information (DI).

With this command, the current decoder operating mode (mono, stereo, etc) can be detected and, if necessary, changed.

Parameters:

<x> Range: 0 to F (ASCII coded hexadecimal numbers)

Example:

STEReo:DIRect "DI=4"

The decoder information is set to "4".

Example:

STEReo:DIRect? "DI"

Response: "4"

STEReo:DIRect "DS=<x>"

STEReo:DIRect? "DS"

(for documentation reasons only)

Selects/activates a storage area in the Stereo/RDS Coder.

Upon activation, the settings stored in the selected area can be loaded.

Use SCPI command [:SOURce] :STEReo:RDS:DATaset instead.

Parameters:

<x> Range: 1 to 5

Example:

STEReo:DIRect "DS=2"

Storage area 2 is activated.

Example:

STEReo:DIRect? "DS"

Response: "2"

STEReo:DIRect "EON-AFA= <PI>,<A>,<Freq#1>,<Freq#2>,..."

STEReo:DIRect? "EON-AFA,<PI>,<z>"

Enhanced Other Networks: defines type A alternative frequencies for the EON with the selected PI.

Parameters:

<PI> Range: 0000 to FFFF (ASCII coded hexadecimal numbers)

<Freq> xxx.x

Sets the alternative frequencies as ASCII coded decimal numbers.

If list <z> is not available, the response is ().

Note: For each Enhanced Other Network (EON), a maximum of five type A alternative frequency lists can be created.

Range: 87.6 to 107.9

Setting parameters:

<A> **N**
 new AF list
 +
 AF list to be added

Query parameters:

<z> AF list to be read
 Range: 1 to 5

Example:

STEReo:DIReCt "EON-AFA=1000,N,97.4,98.3"
 Creates a new type A alternative frequency list for the EON with PI=1000.
 The new list contains the alternative frequencies 97.4 MHz and 98.3 MHz.

Example:

STEReo:DIReCt? "EON-AFA,1000,1"
 Reads the first type A alternative frequency list of the EON with PI=1000.
 Response: "97.4,98.3"

STEReo:DIReCt "EON-AFB= <PI>,<A>,<Freq#1>,<Freq#2>,..."

STEReo:DIReCt? "EON-AFB,<PI>,<z>"

Enhanced Other Networks: defines type B alternative frequencies for the EON with the selected PI.

Parameters:

<PI> Range: 0000 to FFFF (ASCII coded hexadecimal numbers)

<Freq> xxx.x
 Sets the alternative frequencies as ASCII coded decimal numbers.
 If list <z> is not available, the response is ().
Note: For each Enhanced Other Network (EON), a maximum of five type B alternative frequency lists can be created, each list containing max. five frequencies, where <Freq#1> is Tuned Frequency (TF) and <Freq#2..5> are the Mapped Frequencies (MF). A minimum of two frequencies per EON is required.
 Range: 87.6 to 107.9

Setting parameters:

<A> **N**
 new AF list
 +
 AF list to be added

Query parameters:

<z> AF list to be read
 Range: 1 to 5

Example: `STEReo:DIReCt "EON-AFB=1000,N,97.4,98.3"`
 Creates a new type B alternative frequency list for the EON with PI=1000.
 The list contains the alternative frequencies 97.4 MHz and 98.3 MHz.

Example: `STEReo:DIReCt? "EON-AFB,1000,1"`
 Reads the first type B alternative frequency list of the EON with PI=1000.
 Response: "97.4,98.3"

STEReo:DIReCt "EON-DEL=<PI>"

Enhanced Other Networks: deletes the complete EON with selected <PI>.

Parameters:

<PI> Range: 0000 to FFFF (ASCII coded hexadecimal numbers)

Example: `STEReo:DIReCt "EON-DEL=1000"`
 Deletes the EON with PI=1000.

Usage: Setting only

STEReo:DIReCt "EON-PI=<PI>"

STEReo:DIReCt? "EON-PI"

Enhanced Other Networks: creates a new EON or reads the list of the program identification (PI) codes of all EONs created so far.

Note: A maximum of eight EONs can be created.

Parameters:

<PI> **Note:** A four-digit value must always be set. Leading zeros, if any, must also be specified.
 Range: 0000 to FFFF (ASCII coded hexadecimal numbers)

Example: `STEReo:DIReCt "EON-PI=1000"`
 Creates a new EON with PI=1000.

Example: `STEReo:DIReCt? "EON-PI"`
 Response: "1000"

STEReo:DIReCt "EON-PS=<PI>,<PS>"

STEReo:DIReCt? "EON-PS,<PI>"

Enhanced Other Networks: sets the program service (PS) name for the EON with the selected <PI>.

Parameters:

<PI> Range: 0000 to FFFF (ASCII coded hexadecimal numbers)

Setting parameters:

<PS> 8 ASCII characters

Note: An eight-digit value must always be set. Blank spaces, if any, must also be entered, otherwise the value will not be accepted.

Example:

```
STEReo:DIReCt "EON-PS=1000,Test 123"
```

Sets the program service name for the EON with PI=1000 to "Test 123".

Example:

```
STEReo:DIReCt? "EON-PS,1000"
```

Reads the program service name of the EON with PI=1000.

Response: "Test 123"

```
STEReo:DIReCt "EON-PTY=<PI>,<PTY>"
```

```
STEReo:DIReCt? "EON-PTY,<PI>"
```

Enhanced Other Networks: sets the program type (PTY) for the EON with the selected <PI>.

Parameters:

<PI> Range: 0000 to FFFF (ASCII coded hexadecimal numbers)

Setting parameters:

<PTY> Range: 00 to 31 (ASCII coded decimal numbers)

Example:

```
STEReo:DIReCt "EON-PTY=1000,10"
```

Sets the program type for the EON with PI=1000 to "10".

Example:

```
STEReo:DIReCt? "EON-PTY,1000"
```

Reads the program type of the EON with PI=1000.

Response: "10"

```
STEReo:DIReCt "EON-TA=<PI>,<TA>"
```

```
STEReo:DIReCt? "EON-TA,<PI>"
```

Enhanced Other Networks: sets the TA flag for the EON with the selected <PI>.

Parameters:

<PI> Range: 0000 to FFFF (ASCII coded hexadecimal numbers)

Setting parameters:

<TA> 0 | 1

Example:

```
STEReo:DIReCt "EON-TA=1000,1"
```

Sets the TA flag for the EON with PI=1000 to "1".

Example:

```
STEReo:DIReCt? "EON-TA,1000"
```

Reads the TA flag of the EON with PI=1000.

Response: "1"

STEReo:DIRect "EON-TP=<PI>,<TP>"

STEReo:DIRect? "EON-TP,<PI>"

Enhanced Other Networks: sets the TP flag for the EON with the selected <PI>.

Parameters:

<PI> Range: 0000 to FFFF (ASCII coded hexadecimal numbers)

Setting parameters:

<TP> 0 | 1

Example:

STEReo:DIRect "EON-TP=1000,1"

Sets the TP flag for the EON with PI=1000 to "1".

Example:

STEReo:DIRect? "EON-TP,1000"

Reads the TP flag of the EON with PI=1000.

Response: "1"

STEReo:DIRect "GS=<Group#1>,<Group#2>,...<Group#36>"

STEReo:DIRect? "GS"

Sets or reads the group sequence.

Note: Only group A or group B data may be sent at a time. Only groups that contain data are transmitted. The groups 4A, 14B and 15B are automatically added to the group sequence and must not be added or removed manually.

Setting parameters:

<Group> 0A,1A,2A, ... to 15B

Example:

STEReo:DIRect "GS=0A,1B,10A,15A"

The groups 0A,1B,10A,15A are transmitted.

Example:

STEReo:DIRect? "GS"

Response: "0A,1B,10A,15A"

STEReo:DIRect "IMP=<x>"

STEReo:DIRect? "IMP"

(for documentation reasons only)

Sets external L, R impedances.

Use the SCPI command [:SOURCE] :STEReo:EXTernal:IMPedance instead.

Setting parameters:

<x> 1 | 2
 1
 600 Ohm
 2
 100 kOhm

Example: STEReo:DIReCt "IMP=1"
The external impedance is set to 600 Ohm

Example: STEReo:DIReCt? "IMP"
Response: "1"

STEReo:DIReCt

"MASK=<NumbGroups>,<ErrFreeGroups>,<BitMaskBlcA>,<BitMaskBlcB>,<BitMaskBlcC>,<BitMaskBlcD>"

STEReo:DIReCt? "MASK"

Sets a bit mask to generate defined bit errors in the RDS data stream.

Setting parameters:

<NumbGroups> Number of groups to be masked.
If <NumbGroups> is set to zero, the RDS groups are continuously linked to the error mask.
If <NumbGroups> is set to a value other than zero, this value is decremented after each errored group transmitted. When zero count is reached, no further errored groups are transmitted, and **MASK_STATE** is set to "0".

Range: 00 to FF (hexadecimal values)

<ErrFreeGroups> Number of error-free groups to be inserted after each errored group.

Range: 00 to FF (hexadecimal values)

<BitMaskBlc> <BitMaskBlcA>,<BitMaskBlcB>,<BitMaskBlcC>,<BitMaskBlcD>

Hexadecimal bit mask for blocks A, B, C and D of the RDS groups. For each block, 26 bits (16 data bits and 10 CRC bits) have to be entered in hexadecimal code.

Range: 0000000 to 3FFFFFFF

Example: STEReo:DIReCt
"MASK=09,01,0000001,0000000,0000000,0000000"
In nine RDS groups, the least significant bit of the CRC code of block A is inverted, i.e. an errored bit is sent. After each errored group, one error-free group is inserted. After transmission of the complete sequence, **MASK_STATE** is set to "0".
With the command **MASK_STATE=1**, the above sequence (9 errored groups with one error-free group inserted after each errored group) is retransmitted once.
Then, **MASK_STATE** is again set to "0".

Example: STEReo:DIReCt? "MASK"
Response: "09,01,0000001,0000000,0000000,0000000"

STEReo:DIReCt "MASK_STATE=<State>"**STEReo:DIReCt? "MASK_STATE"**

Switches on or off the transmission of defined bit errors in the RDS data stream.

Setting parameters:

<State> 0 | 1

Example:

```
STEReo:DIReCt "MASK_STATE=1"
```

With the command `MASK_STATE=1`, a sequence of errored groups as defined by the `MASK` command is retransmitted once if the number of groups to be masked is other than zero. Then, `MASK_STATE` is automatically set to "0".

If the number of groups to be masked is equal to zero in the `MASK` command (which means continuous error transmission), the masking function can be switched off with `MASK_STATE=0`.

Example:

```
STEReo:DIReCt? "MASK_STATE"
```

Response: "1"

The `MASK_STATE` query provides information as to whether the RDS data stream is linked to an error mask.

```
STEReo:DIReCt "MODE=<EMODE>"
```

```
STEReo:DIReCt? "MODE"
```

(for documentation reasons only)

Sets one of various transmit modes.

Use the SCPI command `[:SOURce] :STEReo:AUDio:MODE` instead.

Setting parameters:

<EMODE> 1 | 2 | 3 | 4 | 5

1

L: signal in left channel only

2

R: signal in right channel only

3

signal of equal frequency and phase in left and right channel

4

signal of equal frequency and opposite phase in left and right channel

5

different, independent signals in left and right channel
(5 is not possible if the internal LF generator is selected as source (SRC = LFGen))

Example:

```
STEReo:DIReCt "MODE=1"
```

Only the signal of the left channel is transmitted.

Example:

```
STEReo:DIReCt? "MODE"
```

Response: "1"

STEReo:DIRect "MS=<Flag>"

STEReo:DIRect? "MS"

Sets or reads the music/speech flag.

The flag signals whether music or speech is being transmitted.

Setting parameters:

<Flag> M | S

Example:

STEReo:DIRect "MS=M"

The music/speech flag is set to "M". This signals that music is currently transmitted.

Example:

STEReo:DIRect? "MS"

Response: "M"

STEReo:DIRect "MPX-DEV=<Deviation>"

STEReo:DIRect? "MPX-DEV"

(for documentation reasons only)

Sets the MPX frequency deviation (max. deviation).

Use the SCPI command [:SOURCE]:STEReo[:DEViation] instead.

Setting parameters:

<Deviation> A five-digit value must always be set. Leading zeros, if any, must also be specified.

Range: 00000 to 10000 (ASCII coded decimal numbers),
corresponding to 0 Hz to 100 kHz

Example:

STEReo:DIRect "MPX-DEV=00201"

Sets the MPX frequency deviation to 2.01 kHz.

Example:

STEReo:DIRect? "MPX-DEV"

Response: "00201"

STEReo:DIRect "PI=<PI>"

STEReo:DIRect? "PI"

Sets or reads the RDS program identification (PI) code.

Setting parameters:

<PI> **Note:** A four-digit value must always be set. Leading zeros, if any, must also be specified, otherwise the value will not be accepted.

Range: 0000 to FFFF (ASCII coded hexadecimal numbers)

Example:

STEReo:DIRect "PI=1234"

The program identification code to be transmitted is set to "1234".

Example: STEReo:DIRect? "PI"
 Response: "1234"

STEReo:DIRect "PIL=<State>"
STEReo:DIRect? "PIL"

(for documentation reasons only)

Activates/deactivates the pilot tone.

Use the SCPI command [:SOURce]:STEReo:PILot:STATe instead.

Setting parameters:

<State> 0 | 1

Example: STEReo:DIRect "PIL=1"
 The pilot tone is activated.

Example: STEReo:DIRect? "PIL"
 Response: "1"

STEReo:DIRect "PIL-DEV=<Deviation>"
STEReo:DIRect? "PIL-DEV"

(for documentation reasons only)

Sets the pilot tone frequency deviation (max. deviation).

Use the SCPI command [:SOURce]:STEReo:PILot[:DEViation] instead.

Setting parameters:

<Deviation> **Note:** A four-digit value must always be set. Leading zeros, if any, must also be specified.

Range: 0000 to 1000 (ASCII coded decimal numbers),
 corresponding to 0 Hz to 10 kHz

Example: STEReo:DIRect "PIL-DEV=1000"
 Sets the frequency deviation of the pilot tone to 10 kHz.

Example: STEReo:DIRect? "PIL-DEV"
 Response: "1000"

STEReo:DIRect "PIL-PH=<Phase>"
STEReo:DIRect? "PIL-PH"

(for documentation reasons only)

Sets the pilot tone phase.

Use the SCPI command [:SOURce]:STEReo:PILot:PHASe instead.

Setting parameters:

<Phase>

Note: A two-digit value must always be set with a sign ("+" or "-") in front of it. Leading zeros, if any, must also be specified.Range: -5.0 to +5.0 (ASCII coded decimal numbers), corresponding to ± 5.0 **Example:**

STEReo:DIReCt "PIL-PH=-33"

The pilot tone phase is set to 3.3

Example:

STEReo:DIReCt? "PIL-PH"

Response: "-33"

STEReo:DIReCt "PRE=<Preemphasis>"**STEReo:DIReCt? "PRE"**

(for documentation reasons only)

Sets one of various preemphasis options.

Use the SCPI commands `[:SOURCE] :STEReo:AUDio:PREEmphasis:STATe` and `[:SOURCE] :STEReo:AUDio:PREEmphasis` instead.**Setting parameters:**

<Preemphasis> 0 | 1 | 2

0

Off

1

50 us

2

75 us

Example:

STEReo:DIReCt "PRE=1"

The preemphasis is set to 50 us.

Example:

STEReo:DIReCt? "PRE"

Response: "1"

STEReo:DIReCt "PRESET"

Sets the default settings in accordance with specifications.

Example:

STEReo:DIReCt "PRESET"

Usage:

Event

STEReo:DIReCt "PS=<PS>"**STEReo:DIReCt? "PS"**

Sets or reads the RDS program service (PS) name.

Setting parameters:

<PS> 8 ASCII characters

Note: An eight-digit value must always be set. Blank spaces, if any, must also be entered, otherwise the value will not be accepted.

Special characters in the program service name are entered with a leading back slash (\) followed by the decimal code of the special character according to table E1 of CENELEC.

Example: `STER:DIR "RT=02,0,test text with \217"`
217 denotes the German ü.

Example:

`STEReo:DIRect "PS=RDS Test"`

Sets the program service name to be transmitted to "RDS Test".

Example:

`STEReo:DIRect? "PS"`

Response: "RDS Test"

STEReo:DIRect "PS-TABLE=<Table>"

STEReo:DIRect? "PS-TABLE"

Selects the character set table to be used for the display of the RDS program service (PS) name in the receiver.

The information concerning the character set is transmitted in segment 0 of the PS. Segment 0 is repeatedly transmitted if the value for `PS-TABLE > 0`. For `PS-TABLE=0` no information concerning the character set is transmitted.

Setting parameters:

<Table> 0 | 1 | 2 | 3

0

no information concerning the character set table in the PS

1

table E.1 is used

2

table E.2 is used

3

table E.3 is used

Example:

`STEReo:DIRect "PS-TABLE=2"`

The information concerning the character set is transmitted in segment 0 of the PS in group 0A. To this end, segment 0 is transmitted repeatedly. At the first transmission segment 0 contains the information about the character set, at the second transmission segment 0 contains the first two characters of the PS.

STEReo:DIRect "PTY=<PTY>"

STEReo:DIRect? "PTY"

Sets or reads the program type (PTY).

Setting parameters:

<PTY>

Note: A two-digit value must always be set. A leading zero, if any, must also be specified.

Range: 00 to 31 (ASCII coded decimal numbers)

Example:

STEReo:DIReCt "PTY=08"

Sets the program type to be transmitted to "08".

Example:

STEReo:DIReCt? "PTY"

Response: "08"

STEReo:DIReCt "PTYN=<PTYN>"

STEReo:DIReCt? "PTYN"

Sets or reads the RDS program type (PTY) name.

Setting parameters:

<PTYN>

8 ASCII characters

Note: An eight-digit value must always be set. Blank spaces, if any, must also be entered, otherwise the value will not be accepted.**Example:**

STEReo:DIReCt "PTYN=Football"

Sets the program type name to be transmitted to "Football".

STEReo:DIReCt "GS=0A,10A"

Group 10A is activated in addition to group 0A. The program type name "Football" is now transmitted.

Example:

STEReo:DIReCt? "PTYN"

Response: "Football"

Example:

STEReo:DIReCt "PTYN="

Transmission of PTYN in group 10A is stopped, even if group 10A is contained in the group sequence.

STEReo:DIReCt "RDS=<State>"

STEReo:DIReCt? "RDS"

(for documentation reasons only)

Switches RDS on or off.

Use the SCPI command [:SOURce]:STEReo:RDS:STATe instead.

Setting parameters:

<State>

0 | 1

Example:

STEReo:DIReCt "RDS=1"

RDS is switched on.

Example:

STEReo:DIReCt? "RDS"

Response: "1"

STEReo:DIReCt "RDS-PH=<Phase>"

STEReo:DIReCt? "RDS-PH"

Sets the RDS phase.

Setting parameters:

<Phase> Range: 000 to 359 (ASCII coded decimal numbers)

Example: STEReo:DIReCt "RDS-PH=100"
The RDS phase is set to 100.

Example: STEReo:DIReCt? "RDS-PH"
Response: "100"

STEReo:DIReCt "RDS-DEV=<Deviation>"

STEReo:DIReCt? "RDS-DEV"

(for documentation reasons only)

Sets the RDS frequency deviation (max. deviation).

Use the SCPI command [:SOURce]:STEReo:RDS[:DEViation] instead.

Setting parameters:

<Deviation> **Note:** A four-digit value must always be set. Leading zeros, if any, must also be specified.

Range: 0000 to 1000 (ASCII coded decimal numbers),
corresponding to 0 Hz to 10.00 kHz)

Example: STEReo:DIReCt "RDS-DEV=0201"
The RDS frequency deviation is set to 2.01 kHz.

Example: STEReo:DIReCt? "RDS-DEV"
Response: "0201"

STEReo:DIReCt "RDS-PRESET"

All RDS specific parameters are deleted or set to a default values.

Example: STEReo:DIReCt "RDS-PRESET"
Sets all RDS parameter to their preset values

Usage: Event

STEReo:DIReCt "RT=<RetranNumber>,<A/
BFlag>,<RadioTextMsg#1>,<RadioTextMsg#2>"

STEReo:DIReCt? "RT"

Radio text

Setting parameters:

<RetranNumber> Range: 00 to 15 (ASCII coded decimal numbers), number
of retransmissions of radio text message

<A/BFlag>	0 1 If the A/B flag is set, the A/B bit in group 2A is toggled to signal that a new radio text message will be transmitted.)
<RadioTextMsg>	max. 64 characters Two texts of 64 characters each can be transmitted in a radio text message Note: For group B, the length of a radio text is limited to 32 characters. Special characters in the radio text are entered with a leading back slash (\) followed by the decimal code of the special character according to table E1 of CENELEC. Example: STER:DIR "RT=02,0,test text with \217" 217 denotes the German ü.
Example:	STEReo:DIRect "RT=02,1,Test message 123" The radio text message "Test message 123" is transmitted.
Example:	STEReo:DIRect? "RT" Response: "02,1,Test message 123"

STEReo:DIRect "SPS=<Time>,<PSN#1>,<PSN#2>,...<PSN#20>"
STEReo:DIRect? "SPS"

Switching program service names (PSN). The program name automatically changed after the set time interval

Parameters:

<PSN>	8 ASCII characters Max. 20 program service names of eight characters each can be entered. Note: The program service names have to be entered as 8-digit texts. Blank spaces, if any, must also be entered, otherwise the value will not be accepted. STEReo:DIRect "SPS=0" stops the transmission of the scrolling PS beendet and starts the transmission of the standard PS.
-------	---

Setting parameters:

<Time>	Time interval in seconds Range: 00 to 59 s
--------	---

Example: STEReo:DIRect "SPS=05,TEST0123,TEST4567"
The program service names "TEST0123" and "TEST4567" are alternately transmitted at an interval of 5 seconds.

Example: STEReo:DIRect? "SPS"
Queries the program service names
Response: "05,TEST0123,TEST4567"

STEReo:DIRect "SRC=<SigSource>"

STEReo:DIRect? "SRC"

(for documentation reasons only)

Selects the signal source.

Use the SCPI command [:SOURce] :STEReo :SOURce instead.

Setting parameters:

<SigSource> 0 | 1 | 2 | 3
0
 Off
1
 external analog (via L and R inputs)
2
 external digital
3
 internal with LF generator

Example: STEReo:DIRect "SRC=1"
 The external analog L and R inputs are selected as source.

Example: STEReo:DIRect? "SRC"
 Response: "1"

STEReo:DIRect? "STATUS"

Status request as to whether the encoder or the update loader program is being executed.

Return values:

<Status> **ENC**
 encoder program is running
UPL
 update loader program is running

Example: STEReo:DIRect? "STATUS"
 Response: "ENC"

Usage: Query only

STEReo:DIRect "STORE=<DataSet#>"

Stores data in the flash memory. All RDS-specific settings are stored in data set <DataSet#> of the flash memory.

Setting parameters:

<DataSet#> Range: 1 to 5

Example: STEReo:DIRect "STORE=1"
 The current settings are stored in data set "1"

Usage: Setting only

STEReo:DIRect "TA=<State>"

STEReo:DIRect? "TA"

(for documentation reasons only)

Sets or reads the traffic announcement flag.

This flag signals whether traffic information is currently being broadcast.

Use the SCPI command `[:SOURCE] :STEReo:RDS:TRAFfic:ANNouncement [:STATE]` instead.

Setting parameters:

<State> 0 | 1

Example:

`STEReo:DIRect "TA=1"`

The traffic announcement flag is set to "1".

Example:

`STEReo:DIRect? "TA"`

Response: "1"

STEReo:DIRect "TP=<State>"

STEReo:DIRect? "TP"

(for documentation reasons only)

Sets or reads the traffic program flag. This flag signals whether traffic information is generally transmitted.

Use the SCPI command `[:SOURCE] :STEReo:RDS:TRAFfic:ANNouncement [:STATE]` instead.

Setting parameters:

<State> 0 | 1

Example:

`STEReo:DIRect "TP=1"`

The traffic program flag is set to "1".

Example:

`STEReo:DIRect? "TP"`

Response: "1"

STEReo:DIRect "TRANS<DataNumber>=<DataStream>"

STEReo:DIRect? "TRANS<DataNumber>"

Transparent mode.

An RDS data stream of binary data is generated. If transparent data is selected, all other RDS data is ignored.

Parameters:

<DataNumber> Max. 20 different data sequences can be defined.

Range: 0 to 13

<DataStream>	<p>16 ASCII coded hexadecimal characters (blocks A to D of the RDS groups)</p> <p>TRANS=0 deletes all transparent data and switches back to normal RDS data transmission.</p> <p>Note: 16 characters must be specified for each data sequence. Leading zeros, if any, must also be specified. The data will be transmitted even if it constitutes no meaningful RDS data.</p>
Example:	<pre>STEReo:DIReCt "TRANS1=0123456789ABCDEF"</pre> <p>The data "0123456789ABCDEF" is sent instead of the RDS data.</p>
Example:	<pre>STEReo:DIReCt? "TRANS1"</pre> <p>Reads the transparent data.</p> <p>Response: "0123456789ABCDEF"</p>

7.19.2 Examples

7.19.2.1 Alternative Frequency Lists

Alternative frequency lists can be transmitted in two ways:

- **Method A:**
The frequencies of an AF list are entered one after the other; the frequency currently transmitted has to be specified as the first frequency.
- **Method B:**
The frequencies of an AF list are entered in pairs, each pair containing the frequency currently transmitted and an alternative frequency. The frequency pairs should normally be entered in ascending order. Descending order should be chosen only if the alternative frequencies belong to different regions or are used to broadcast different programs at different times.



Do not combine methods A and B!

Method A:

1. Generate a new alternative frequency list with

```
STEReo:DIReCt "AF=N, 87.6, 87.7, 87.8".
```
2. Set the group sequence, e.g.

```
STEReo:DIReCt "GS=0A, 14A".
```

The group sequence must contain group 0A.
The alternative frequencies are now transmitted in group 0A.
3. Add another alternative frequency list with

```
STEReo:DIReCt "AF=+, 88.6, 88.7, 88.8"
```

Method B:

1. Generate a new alternative frequency list with
`STEReo:DIReCt "AF=N,87.6,90.2,87.6,90.2"`.
2. Set the group sequence, e.g.
`STEReo:DIReCt "GS=0A,14A"`.
 The group sequence must contain group 0A
 The alternative frequencies are now transmitted in group 0A.
3. Add another alternative frequency list with
`STEReo:DIReCt "AF=+,88.6,91.2,88.6,91.2"`

The frequency lists are not checked for correctness. For this reason, make sure that the syntax is correct.

A maximum of five AF lists can be generated. For type A lists, max. 25 frequencies per list can be specified, for type B lists, max. 12 frequencies per list.

7.19.2.2 Enhanced Other Networks**Creating an EON data set**

1. Read the list of existing EON data sets with
`STEReo:DIReCt? "EON-PI"`
 The list shows the EON PI codes already used and those remaining for new data sets.
2. Create an EON data set with
`STEReo:DIReCt "EON-PI=1234"`
3. Set the program service (PS) name for the EON data set with
`STEReo:DIReCt "EON-PS=1234,TEST EON"`
4. Set the group sequence, e.g.:
`STEReo:DIReCt "GS=0A,14A"`
 Group 14A with variants 0 to 3 is now transmitted.
5. Create a new AF list for the EON:
 - a) Using method A
`STEReo:DIReCt "EON-AFA=1234,N,87.6,87.7,87.8"`
 - b) Create further AF lists for the EON, using method A:
`STEReo:DIReCt "EON-AFA=1234,+,88.6,88.7,88.8"`
 - c) Read the first AF list of the EON with
`STEReo:DIReCt? "EON-AFA,1234,1"`
6. Create a new AF list for the EON, using method B:
`STEReo:DIReCt "EON-AFB=1234,N,87.6,87.7,87.8"`
 where 87.6 = tuned frequency,
 87.7 = mapped frequency 1(variant 5),

87.8 = mapped frequency 2 variant 6)

Note: Do not combine methods A and B for generating EON alternative frequency lists.

A maximum of five AF lists can be generated. For type A lists, max. 25 frequencies per list can be specified, for type B lists, max. five frequencies per list.

7.19.2.3 Free Format Groups (FFGs)

In the user-definable groups 1A, 3A, 5A, 6A, 7A, 8A, 9A, 10A, 11A, 12A and 13A, any desired data can be transmitted. Five bits of this data are transmitted in block B and 16 bits each in blocks C and D of the specified group.

1. Define the data to be transmitted in group 1A:

```
STEReo:DIReCt "1A=05,0000000000,1FFFFFFFFF"
```

Group 1A is now transmitted first with "0000000000" and then with "1FFFFFFFFF".

Each of the two data sequences is retransmitted five times, which is indicated by the information "05".

2. Set the group sequence, e.g.:

```
STEReo:DIReCt "GS=0A,1A"
```

The defined data is now transmitted in group 1A.

Max. 20 different data sequences can be defined.

7.19.2.4 Transparent-Mode

The transparent mode allows the user to transmit freely definable binary data instead of the standard RDS data. Blocks A to D of the RDS groups are used. This means that standard RDS data will no longer be transmitted when transparent data is set. The binary data will be sent even if it constitutes no valid or meaningful RDS data. The transmission of standard RDS data will not be resumed until the transparent data is deleted.

1. Transmit the alternating sequences '0123456789ABCDEF' and 'ABCDEF0123456789' instead of the RDS data:

```
STEReo:DIReCt "TRANS=0123456789ABCDEF,ABCDEF0123456789"
```

2. Delete the transparent data and switch back to standard RDS data transmission with:

```
STEReo:DIReCt "TRANS=0"
```

Max. 20 different data sequences can be defined.

8 Maintenance

The instrument does not need periodic maintenance. Only the cleaning of the instrument is essential. The outside of the instrument is suitably cleaned using a soft, lint-free dust cloth. Make sure that the air vents are not obstructed.

WARNING

Shock hazard

Before cleaning the instrument, make sure that the instrument is switched off and disconnected from all power supplies.

NOTICE

Instrument damage caused by cleaning agents

Cleaning agents contain substances that may damage the instrument. For example, cleaning agents that contain a solvent may damage the front panel labeling, plastic parts, or the display.

Never use cleaning agents such as solvents (thinners, acetone, etc), acids, bases, or other substances.

The outside of the instrument can be cleaned sufficiently using a soft, lint-free dust cloth.

Follow the instructions in the service manual and the safety instructions when exchanging modules or ordering spares. The order no. for spare parts is included in the service manual. The service manual includes further information particularly on troubleshooting, repair, exchange of modules and alignment.

The address of our support center and a list of all Rohde & Schwarz service centers can be found at the beginning of this manual.

8.1 Storing and Packing

The storage temperature range of the instrument is given in the data sheet. If the instrument is to be stored for a longer period of time, it must be protected against dust.

Repack the instrument as it was originally packed when transporting or shipping. The two protective foam plastic parts prevent the control elements and connectors from being damaged. The antistatic packing foil avoids any undesired electrostatic charging to occur.

If you do not use the original packaging, use a sturdy cardboard box of suitable size and provide for sufficient padding to prevent the instrument from slipping inside the package. Wrap antistatic packing foil around the instrument to protect it from electrostatic charging.

9 Status Information, Error Messages and Troubleshooting

The R&S SMB distinguishes between a variety of different messages such as status messages, error messages, warnings, or information that are displayed in the "Info" line on the screen, and also entered in the error/event queue of the status reporting system.

This section describes the information and status messages concerning the operating status of the instrument and the types of error messages and warnings. Some error messages require that the error must be eliminated before correct instrument operation can be ensured. The info window with a list of current messages and a detailed description of each message can be opened with the INFO key.

In the remote control mode, error messages are entered in the error/event queue of the status reporting system and can be queried with the command `SYSTEM:ERROR?`. If the error queue is empty, 0 ("No error") is returned. The status reporting system is described in detail in [Chapter 6.5, "Status Reporting System"](#), on page 269.

Section [Chapter 9.5, "Resolving Network Connection Failures"](#), on page 487 provides recommended solutions for network connection errors, and helps you to collect the information required for quick and efficient support.

9.1 Status Information

The status messages are displayed in the header section of the screen. The status information gives the user an overview of the main operating states and settings of the instrument. The states are indicated for information only and do not necessitate any action by the user. Status information is displayed between the frequency and level fields, at the left of the info line or in the info line itself.

9.1.1 Status information displayed between the frequency and level fields

This section gives an overview of the status messages displayed between the frequency and level fields.

RF OFF

The RF output is switched off

MOD OFF

All modulations are switched off

FREQ OFFSET

A frequency offset is set.

The frequency entered and displayed in the "Frequency" field takes any set frequency offset into consideration, e.g. an offset set for a downstream instrument. This means that with a frequency offset the frequency displayed in the header does not correspond to the frequency at the RF output, but rather to the frequency at the output of the downstream instrument.

This allows the target frequency at the output of a downstream instrument to be entered in the frequency field. The signal generator changes the RF output frequency according to the entered offset.

However, the frequency entered and displayed in the "Frequency/Phase" dialog of the "RF" function block always corresponds to the RF output frequency. Any frequency offset is not taken into consideration.

The correlation is as follows:

Freq in header = RF output frequency (= Freq in dialog) + Freq offset (= Offset in dialog)

OVERLOAD

The power of the external signal applied to the RF output is too high. The overload protection is tripped and the connection between the RF output and attenuator is interrupted. The overload protection is reset by pressing the RF ON/OFF key. The RF input is activated when the overload protection is reset.

LEVEL OFFSET

A level offset is set.

The level entered and displayed in the "Level" field takes the offset of any downstream attenuators/amplifiers into consideration by way of calculation. This means that with a level offset the level displayed in the header does not correspond to the level at the RF output, but rather to the level at the output of the downstream instrument.

This allows the target level at the output of downstream instruments to be entered. The signal generator changes the RF output level according to the set offset.

However, the level entered and displayed in the "Level" dialog of the "RF" function block always corresponds to the RF output level. Any level offset is not taken into consideration.

The correlation is as follows:

Level in header = RF output level (= Level in dialog) + Level offset

EXT REF

An external reference is used.

The external signal with selectable frequency and defined level must be input at the REF IN connector. It is output at the REF OUT connector.

BUSY

A setting or calculation is executed.

9.1.2 Status information displayed to the left of the Info line

This section gives an overview of the status messages displayed to the left of the Info line.

REMOTE

Indicates that the instrument is in remote control mode.

The keys on the front panel are usable, but all parameters are in read only mode.

To return to manual control, use the LOCAL key or the command `>L`. The current command must be fully processed before the mode is switched, otherwise the instrument switches immediately back to remote control.

REM-LLO

Indicates that the instrument is in remote control mode with local lockout enabled.

The LOCAL key is locked. To set the local lockout, use the command `&LLO` (local lockout).

The keys on the front panel are usable, but all parameters are in read only mode.

To return to manual operation or to "REMOTE" state, use one of the following commands:

- `&LOCS`
switches directly from "REM-LLO" to manual operation.
- `&REMS`
changes the remote control state from "REM-LLO" to "REMOTE".
- `CALL IBLOC (generator%)` (Visual Basic command)
switches from remote control state to manual operation.

LOC-LLO

For the direct operation the state has been changed from remote control to manual operation (local state). The LOCAL key was disabled with the command `LLO` (local lockout).

With the next activating of the remote control mode, the instrument cannot be switched to manual operation by the operator. The status information changes to "REM-LLO".

The instrument can be switched to manual operation by means of remote control only (e.g. with the Visual Basic command `CALL IBLOC (generator%)`).

9.1.3 Status information displayed in the Info line

This section gives an overview of the status messages displayed in the Info line.

RFSweep / LevelSweep / LFSweep

The indicated sweep is enabled.

ALC On / Auto / S&H

The status of the automatic level control is indicated:

- ON
automatic level control permanently on

- **Auto**
automatic level control is automatically adapted to the operating states
- **S&H**
automatic level control off, recalibration of the level whenever the level or frequency is set (sample and hold mode)

ListMode

List mode is active.

The values of the frequency/level pairs in the selected list are set for the chosen dwell time.

AttFixed

Attenuator fixed mode is active.

The uninterrupted level settings are made in a fixed range without attenuator switching. The variation range is set automatically when this mode is activated. The range is displayed under "Attenuator Fixed Range" in the "Level" dialog.

UCorr

User Correction is active.

The level is corrected by the given values in the selected user correction list. Correction is performed by the user-defined list values being added to the output level for the respective RF frequency. With frequencies which are not contained in the list, the level correction is determined by interpolation of the closest correction values.

OvenCold

The reference oscillator has not yet reached its nominal frequency.

When switching on from the STANDBY mode, the specified frequency accuracy is reached immediately. If the power switch was switched off, the reference oscillator needs some warm-up time to reach its nominal frequency. During this period of time, the output frequency does not yet reach its final value either.

9.2 Error Messages

Messages indicate errors in the instrument. They are displayed in the info line in different colors depending on their importance and display duration. Errors (e.g. no calibration data) are displayed in red, information (e.g. file not found) and warnings in black. Warnings indicate less significant errors (e.g. the instrument operates outside specified data).

9.2.1 Volatile messages

Volatile messages report automatic settings in the instrument (e.g. switching off of incompatible types of modulation) or on illegal entries that are not accepted by the instrument (e.g. range violations). They are displayed in the info line on a yellow background. They are displayed on top of status information or permanent messages.

Volatile messages do not normally demand user actions and disappear automatically after a brief period of time. They are stored in the history, however.

SCPI command: `:SYSTem:ERRor:ALL?` or `:SYSTem:ERRor[:NEXT]?`

9.2.2 Permanent messages

Permanent messages are displayed if an error occurs that impairs further instrument operation, e.g. a hardware fault. The error signaled by a permanent message must be eliminated before correct instrument operation can be ensured.

The message is displayed until the error is eliminated. It covers the status display in the info line. After error elimination, the message automatically disappears and is also recorded in the history.

SCPI command: `:SYSTem:SERRor?`

9.3 SCPI-Error Messages

The SCPI error messages are the same in all SCPI instruments. Detailed information and an overview of all error messages as defined in SCPI standard can be found in the corresponding documentation.

The errors are assigned negative numbers. The error text being entered into the error/event queue or being displayed is printed in bold face on the left together with the error code. Below the error text, there is an explanation as to the respective error.

9.4 Device-Specific Error Messages

The following table contains all error messages specific for the instrument in alphabetical order, as well as an explanation of the error situation. The positive error codes mark the errors specific of the instrument.

The device-specific error messages set bit 3 in the ESR register.



The index provides a list of the error messages sorted according to their error codes.

Error Code	Error	Description	Remedy
50	Extern reference out of range or disconnected	External reference is selected but no external signal is applied or the signal is out of range.	<ul style="list-style-type: none"> Check the selected reference signal source (internal or external) in the "Setup > Reference Oscillator" dialog. Change setting to 'internal' if no appropriate external source is available.
140	This modulation forces other modulations off	A modulation has been switched on which cannot be used at the same time as an already active modulation. The previous modulation has been switched off. Example: Enabling FM modulation switches PM modulation off.	
180	Adjustment failed	Adjustment could not be executed	The adjustment data have to be generated first by an internal or external adjustment or to be loaded into the device (see Chapter 5.2.3.1, "Internal Adjustments" , on page 92).
182	Adjustment data missing	Adjustment data are missing.	The adjustment data have to be generated first by an internal or external adjustment or to be loaded into the instrument.
183	Adjustment data invalid	Adjustment data are invalid and must be restored.	The adjustment data have to be generated again by an internal or external adjustment or to be loaded into the instrument.
200	Cannot access hardware	The data transmission to a module was unsuccessful.	The module is not installed, not properly installed or missing.
201	Hardware revision out of date	A later version of certain parts of the instrument is necessary to execute the function selected.	The driver does not support the installed version of a module.
202	Cannot access the EEPROM	A error occurs when writing or reading a EEPROM.	The EEPROM might be defect and has to be replaced.
203	Invalid EEPROM data	Reading a EEPROM is possible, however the data are inconsistent.	
204	Driver initialization failed	Initialization of a driver fails when booting the instrument firmware.	The driver is not compatible with the hardware or software configuration of the instrument.
241	No current list	There is no list selected. To execute the required operation, a list has to be selected in the related menu.	If no list is available, a new list must be created.
242	Unknown list type specified	The list type selected is not valid for the required operation. For instance, the file extension for waveform list files is *.vv. It is not possible to enter another file extension when selecting a list.	Check the selected list type.

Error Code	Error	Description	Remedy
460	Cannot open file	The selected file can not be opened.	Check the path and file name.
461	Cannot write file	The file can not be written.	Check if the file is read-only.
462	Cannot read file	The file can not be read.	Check if the file contents are compatible with the file type.
463	Filename missing	The required operation cannot be executed because the file name is not specified.	A file name has to be entered when creating a new list.
464	Invalid filename extension	The file extension is not valid for the required operation.	Check the file extension. For instance, the file extension for waveform list files is *.wv. It is not possible to enter another file extension when storing a list.
465	File contains invalid data	The selected file contains data that is not valid for the file type. The file extension determines the data that is valid for this file type. If the file extension is changed the lists are no longer recognized and the data are therefore invalid. Example: the extension of a waveform file (= *.wv) was changed to *.txt	Check the file extension.



Stereocoder error messages

An error occurred concerning the stereo coder option R&S SMB-B5. Refer to the service manual, chapter 3, section "Troubleshooting" for error correction.

9.5 Resolving Network Connection Failures

Several issues may cause failures in the network connection to the instrument. This section lists the most likely reasons and the recommended solutions.

Common reasons for network connection failures

- Network connecting cables and cable connectors of poor quality
- Incompatibility between the network interface of the R&S SMB and certain switches or routers available on the market
- An invalid IP address assigned to the instrument

Possible solutions

NOTICE

Risk of connection errors

Before configuring the network, changing IP addresses or exchanging hardware, consult your network administrator.

Connection errors can affect the entire network.

- Check the network infrastructure. Exchange connecting cables if obvious damage is visible.
- Observe the link status LED on the R&S SMB or the connected network device. The link status LED is located next to the LAN connector. If a link failure is detected, connect the instrument to a different device port or to a different network device.
- Check whether the LAN interface and the required LAN services are enabled. See "[LAN Services](#)" on page 116.
- Check whether the IP address of the instrument is within the network's address range. See [Chapter 5.2.3.12, "Network Settings"](#), on page 104. Check whether IP addresses that were set manually or obtained via the Zeroconf (APIPA) protocol are valid.

9.6 Obtaining Technical Support

If problems occur, the instrument generates error messages which in most cases will be sufficient for you to detect the cause of an error and find a remedy. Error message types are described in [Chapter 9, "Status Information, Error Messages and Troubleshooting"](#), on page 481.

In addition, our customer support centers are there to assist you in solving any problems that you may encounter with your R&S SMB. We will find solutions more quickly and efficiently if you provide us with the information listed below.

- The following dialog boxes in the "Setup > System" menu provide useful information:
 - **Hardware Configuration:** hardware assemblies
 - **Software/Options:** the status of all software and hardware options installed on your instrument
- **System Messages:** displayed in the "Info" line and provide information on any errors that may have occurred

Collect the error information and send an e-mail in which you describe the problem to the customer support address for your region as listed at the beginning of the R&S SMB Getting Started manual.

To remove sensitive data

- ▶ For information on how to handle or remove the sensitive data from your instrument, refer to the description "Resolving Security Issues when working with R&S SMB", provided at the product homepage.

**Packing and transporting the instrument**

If the instrument needs to be transported or shipped, e.g. due to damage during delivery, observe the notes described in [Chapter 2.3.2, "Unpacking and Checking the Instrument"](#), on page 26.

Annex

A Hardware Interfaces

This section covers hardware related topics, like pin assignment of the GPIB bus interface.

The remote control interfaces are described in details in [Chapter 6, "Remote Control Basics"](#), on page 235.

All other interfaces are described in sections "Legend of Front Panel" and "Legend of Rear Panel" in the Quick Start Guide.

For specifications refer to the data sheet.

A.1 GPIB Bus Interface

Pin assignment

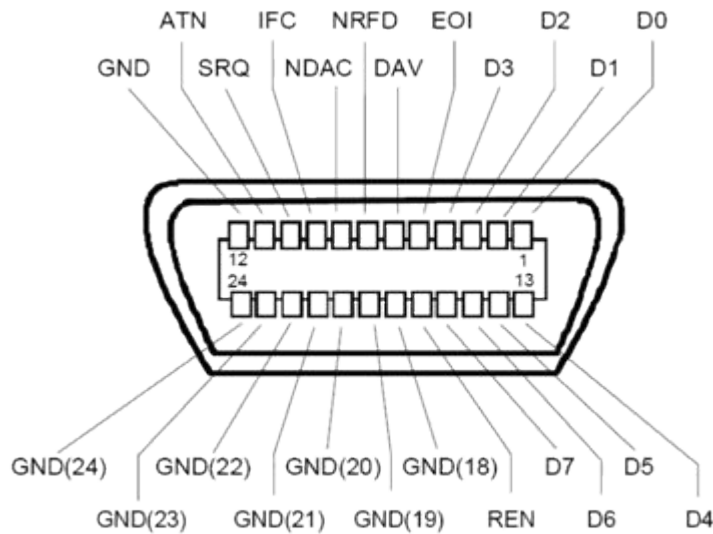

Figure A-1: Pin assignment of GPIB bus interface

Bus lines

- Data bus with 8 lines D0 to D7:
The transmission is bit-parallel and byte-serial in the ASCII/ISO code. D0 is the least significant bit, D7 the most significant bit.
- Control bus with five lines:

IFC (Interface Clear): active LOW resets the interfaces of the instruments connected to the default setting.

ATN (Attention): active LOW signals the transmission of interface messages, inactive HIGH signals the transmission of device messages.

SRQ (Service Request): active LOW enables the connected device to send a service request to the controller.

REN (Remote Enable): active LOW permits switchover to remote control.

EOI (End or Identify): has two functions in connection with ATN:

- ATN=HIGH active LOW marks the end of data transmission.
- ATN=LOW active LOW triggers a parallel poll.

- Handshake bus with three lines:

DAV (Data Valid): active LOW signals a valid data byte on the data bus.

NRFD (Not Ready For Data): active LOW signals that one of the connected devices is not ready for data transfer.

NDAC (Not Data Accepted): active LOW signals that the instrument connected is accepting the data on the data bus.

Interface Functions

Instruments which can be controlled via GPIB bus can be equipped with different interface functions. The interface function for the R&S SMB are listed in the following table.

Table A-1: GPIB bus interface functions

Control character	Interface function
SH1	Handshake source function (source handshake), full capability
AH1	Handshake sink function (acceptor handshake), full capability
L4	Listener function, full capability, de-addressed by MTA.
T6	Talker function, full capability, ability to respond to serial poll, de-addressed by MLA
SR1	Service request function (Service Request), full capability
PP1	Parallel poll function, full capability
RL1	Remote/Local switch over function, full capability
DC1	Reset function (Device Clear), full capability
DT1	Trigger function (Device Trigger), full capability

List of Commands

:CALibration<hw>:ALL[:MEASure]?	286
:CALibration<hw>:FMOFFset[:MEASure]?	286
:CALibration<hw>:FREQuency[:MEASure]?	287
:CALibration<hw>:LEVel:EXTErn:DATA	287
:CALibration<hw>:LEVel[:MEASure]?	287
:CALibration<hw>:ROSCillator[:DATA]	288
:DEvice:PRESet	284
:DIAGnostic:INFO:OTIME?	289
:DIAGnostic:INFO:POCounT?	290
:DIAGnostic<hw>:BGINfo:CATalog?	289
:DIAGnostic<hw>:BGINfo?	288
:DISPlay:ANNotation:AMPLitude	290
:DISPlay:ANNotation:FREQuency	291
:DISPlay:ANNotation[:ALL]	291
:DISPlay:DIALog:CLOSe	291
:DISPlay:DIALog:CLOSe:ALL	291
:DISPlay:DIALog:ID?	291
:DISPlay:DIALog:OPEN	292
:DISPlay:PSAVe:HOLDoff	292
:DISPlay:PSAVe[:STATe]	292
:DISPlay:UPDate	293
:FORMat:BORDER	293
:FORMat:SREGister	294
:FORMat[:DATA]	294
:HCOPy:DATA?	295
:HCOPy:DEvice	295
:HCOPy:DEvice:LANGUage	296
:HCOPy:FILE[:NAME]	296
:HCOPy:FILE[:NAME]:AUTO:DIRectory	297
:HCOPy:FILE[:NAME]:AUTO:DIRectory:CLEar	297
:HCOPy:FILE[:NAME]:AUTO:FILE?	297
:HCOPy:FILE[:NAME]:AUTO:STATe	301
:HCOPy:FILE[:NAME]:AUTO?	297
:HCOPy:FILE[:NAME]:AUTO[:FILE]:DAY:STATe	298
:HCOPy:FILE[:NAME]:AUTO[:FILE]:DAY?	298
:HCOPy:FILE[:NAME]:AUTO[:FILE]:MONTH:STATe	299
:HCOPy:FILE[:NAME]:AUTO[:FILE]:MONTH?	299
:HCOPy:FILE[:NAME]:AUTO[:FILE]:NUMBer?	299
:HCOPy:FILE[:NAME]:AUTO[:FILE]:PREFix	300
:HCOPy:FILE[:NAME]:AUTO[:FILE]:PREFix:STATe	300
:HCOPy:FILE[:NAME]:AUTO[:FILE]:YEAR:STATe	300
:HCOPy:FILE[:NAME]:AUTO[:FILE]:YEAR?	300
:HCOPy:IMAGe:FORMat	301
:HCOPy:IMAGe:SIZE	301
:HCOPy[:EXECute]	296
:INITiate<ch>[:POWer]:CONTInuous	316
:KBOard:LANGUage	302

:KBOard:LAYout.....	302
:MEMory:HFRee?.....	309
:MMEMory:CATalog:LENGth?.....	306
:MMEMory:CATalog?.....	306
:MMEMory:CDIRectory.....	306
:MMEMory:COPIY.....	307
:MMEMory:DATA.....	307
:MMEMory:DCATalog:LENGth?.....	308
:MMEMory:DCATalog?.....	308
:MMEMory:DELeTe.....	309
:MMEMory:LOAD:STATe.....	309
:MMEMory:MDIRectory.....	310
:MMEMory:MOVE.....	310
:MMEMory:MSIS.....	310
:MMEMory:RDIRectory.....	311
:MMEMory:STORe:STATe.....	311
:OUTPut<hw>:AFIXed:RANGe:LOWer?.....	312
:OUTPut<hw>:AFIXed:RANGe:UPPer?.....	312
:OUTPut<hw>:ALC:SEARch:MODE.....	312
:OUTPut<hw>:AMode.....	313
:OUTPut<hw>:FILTer:AUTO.....	313
:OUTPut<hw>:FILTer[:LPASs]:STATe.....	313
:OUTPut<hw>:IMPedance?.....	314
:OUTPut<hw>:PROTection:CLear.....	314
:OUTPut<hw>:PROTection:TRIPped?.....	314
:OUTPut<hw>[:STATe].....	314
:OUTPut<hw>[:STATe]:PON.....	315
:READ<ch>[:POWer]?.....	317
:SENSe<ch>:UNIT[:POWer].....	324
:SENSe<ch>[:POWer]:APERTure:DEFault:STATe.....	316
:SENSe<ch>[:POWer]:APERTure:TIME.....	316
:SENSe<ch>[:POWer]:CORRection:SPDevice:STATe.....	317
:SENSe<ch>[:POWer]:DISPlay:PERManent:PRiority.....	318
:SENSe<ch>[:POWer]:DISPlay:PERManent:STATe.....	318
:SENSe<ch>[:POWer]:FILTer:LENGth:AUTO?.....	318
:SENSe<ch>[:POWer]:FILTer:LENGth[:USER].....	319
:SENSe<ch>[:POWer]:FILTer:NSRatio.....	319
:SENSe<ch>[:POWer]:FILTer:NSRatio:MTIME.....	320
:SENSe<ch>[:POWer]:FILTer:SONCe.....	320
:SENSe<ch>[:POWer]:FILTer:TYPE.....	320
:SENSe<ch>[:POWer]:FREQUency.....	321
:SENSe<ch>[:POWer]:LOGGing:STATe.....	321
:SENSe<ch>[:POWer]:OFFSet.....	322
:SENSe<ch>[:POWer]:OFFSet:STATe.....	322
:SENSe<ch>[:POWer]:SOURce.....	323
:SENSe<ch>[:POWer]:ZERO.....	324
:SOURce<hw>:PRESet.....	285
:STATus:OPERation:CONDition.....	429
:STATus:OPERation:ENABle.....	430
:STATus:OPERation:NTRansion.....	430

:STATus:OPERation:PTRansition.....	430
:STATus:OPERation[:EVENT].....	430
:STATus:PRESet.....	431
:STATus:QUEStionable:CONDition.....	431
:STATus:QUEStionable:ENABle.....	431
:STATus:QUEStionable:NTRansition.....	432
:STATus:QUEStionable:PTRansition.....	432
:STATus:QUEStionable[:EVENT].....	431
:STATus:QUEue[:NEXT]?.....	432
:SYSTem:COMMunicate:GPIB:LTERminator.....	437
:SYSTem:COMMunicate:GPIB:RESource?.....	441
:SYSTem:COMMunicate:GPIB[:SELF]:ADDRess.....	438
:SYSTem:COMMunicate:HISLip:RESource?.....	441
:SYSTem:COMMunicate:NETWork:IPADdress.....	439
:SYSTem:COMMunicate:NETWork:IPADdress:MODE.....	439
:SYSTem:COMMunicate:NETWork:MACAddress.....	440
:SYSTem:COMMunicate:NETWork:RESource?.....	441
:SYSTem:COMMunicate:NETWork:REStart.....	440
:SYSTem:COMMunicate:NETWork:STATus?.....	440
:SYSTem:COMMunicate:NETWork[:COMMOn]:DOMain.....	438
:SYSTem:COMMunicate:NETWork[:COMMOn]:HOSTname.....	438
:SYSTem:COMMunicate:NETWork[:COMMOn]:WORKgroup.....	438
:SYSTem:COMMunicate:NETWork[:IPADdress]:DNS.....	439
:SYSTem:COMMunicate:NETWork[:IPADdress]:GATeway.....	439
:SYSTem:COMMunicate:NETWork[:IPADdress]:SUBNet:MASK.....	440
:SYSTem:COMMunicate:SERial:BAUD.....	442
:SYSTem:COMMunicate:SERial:PARity.....	442
:SYSTem:COMMunicate:SERial:RESource?.....	442
:SYSTem:COMMunicate:SERial:SBITs.....	443
:SYSTem:COMMunicate:SOCKet:RESource?.....	443
:SYSTem:COMMunicate:USB:RESource?.....	441
:SYSTem:DATE.....	445
:SYSTem:DISPlay:UPDate.....	445
:SYSTem:DLOCK.....	436
:SYSTem:ERRor:ALL?.....	434
:SYSTem:ERRor:CODE:ALL?.....	434
:SYSTem:ERRor:CODE[:NEXT]?.....	435
:SYSTem:ERRor:COUNT?.....	435
:SYSTem:ERRor[:NEXT]?.....	435
:SYSTem:FPReset.....	285
:SYSTem:HCLear.....	446
:SYSTem:IDENtification.....	443
:SYSTem:KLOCK.....	436
:SYSTem:LANGuage.....	443
:SYSTem:MMEMory:PATH:USER?.....	447
:SYSTem:OSYStem?.....	447
:SYSTem:PRESet.....	285
:SYSTem:PROTect<ch>[:STATe].....	444
:SYSTem:REBoot.....	444
:SYSTem:REStart.....	444

:SYSTem:SERRor?	436
:SYSTem:SHUTdown	445
:SYSTem:STARtup:COMPLete?	445
:SYSTem:TIME	446
:SYSTem:TIME:ZONE	446
:SYSTem:TIME:ZONE:CATalog?	446
:SYSTem:ULOCK	437
:SYSTem:VERSion?	447
:SYSTem:WAIT	447
:TEST<hw>:ALL:RESUlt?	448
:TEST<hw>:ALL:STARt	448
:TEST<hw>:DIRect	449
:TRIGger<hw>:FSWeep:SOURce	450
:TRIGger<hw>:FSWeep[:IMMediate]	451
:TRIGger<hw>:LFFSweep	452
:TRIGger<hw>:LFFSweep:IMMediate	452
:TRIGger<hw>:LFFSweep:SOURce	452
:TRIGger<hw>:PSWeep:SOURce	453
:TRIGger<hw>:PSWeep[:IMMediate]	453
:TRIGger<hw>[:IMMediate]	455
:TRIGger<hw>[:SWEep]:SOURce	454
:TRIGger<hw>[:SWEep][:IMMediate]	455
:UNIT:ANGLE	455
:UNIT:POWer	456
[:SOURce]:CALibration:STEReo:ANALog[:MEAS]?	288
[:SOURce]:CORRection:CSET:CATalog?	329
[:SOURce]:CORRection:CSET:DELeTe	331
[:SOURce]:INPut:TRIGger:SLOPe	348
[:SOURce]:LFOutput:SHAPE	357
[:SOURce]:LFOutput:SIMPedance	358
[:SOURce]:LFOutput:VOLTagE	358
[:SOURce]:LFOutput[:STATe]	352
[:SOURce]:LFOutput<ch>:FREQuency	349
[:SOURce]:POWer:WIGNore	381
[:SOURce]:PULM[:INTernal][:TRAIIn]:TRIGger:IMMediate	400
[:SOURce]:ROSCillator:EXTernal:FREQuency	405
[:SOURce]:ROSCillator:EXTernal:RFOFF[:STATe]	406
[:SOURce]:ROSCillator:EXTernal:SBANdwidth	406
[:SOURce]:ROSCillator:SOURce	407
[:SOURce]:ROSCillator[:INTernal]:ADJust:VALue	406
[:SOURce]:ROSCillator[:INTernal]:ADJust[:STATe]	407
[:SOURce]:STEReo:ARI:BK[:CODE]	408
[:SOURce]:STEReo:ARI:STATe	409
[:SOURce]:STEReo:ARI:TYPE	409
[:SOURce]:STEReo:ARI:TYPE:STATe	410
[:SOURce]:STEReo:ARI[:DEViation]	410
[:SOURce]:STEReo:AUDio:MODE	410
[:SOURce]:STEReo:AUDio:PREEmphasis	411
[:SOURce]:STEReo:AUDio:PREEmphasis:STATe	412
[:SOURce]:STEReo:AUDio:FREQuency	412

[:SOURce]:STEReo:DIRect.....	412
[:SOURce]:STEReo:EXTernal:IMPedance.....	413
[:SOURce]:STEReo:MMF.....	413
[:SOURce]:STEReo:PILot:PHASe.....	413
[:SOURce]:STEReo:PILot:STATe.....	414
[:SOURce]:STEReo:PILot[:DEViation].....	414
[:SOURce]:STEReo:RDS:DATaset.....	414
[:SOURce]:STEReo:RDS:STATe.....	414
[:SOURce]:STEReo:RDS:TRAFfic:ANNouncement[:STATe].....	415
[:SOURce]:STEReo:RDS:TRAFfic:PROGram[:STATe].....	415
[:SOURce]:STEReo:RDS[:DEViation].....	415
[:SOURce]:STEReo:SOURce.....	416
[:SOURce]:STEReo:STATe.....	416
[:SOURce]:STEReo[:DEViation].....	417
[:SOURce<hw>]:AM:DEPTh:EXPonential.....	325
[:SOURce<hw>]:AM:DEPTh:LINear.....	326
[:SOURce<hw>]:AM:EXTernal:COUPling.....	326
[:SOURce<hw>]:AM:SENSitivity?.....	327
[:SOURce<hw>]:AM:SOURce.....	327
[:SOURce<hw>]:AM:STATe.....	328
[:SOURce<hw>]:AM:TYPE.....	328
[:SOURce<hw>]:CORRection:CSET:DATA:FREQuency.....	330
[:SOURce<hw>]:CORRection:CSET:DATA:FREQuency:POINts?.....	330
[:SOURce<hw>]:CORRection:CSET:DATA:POWer.....	330
[:SOURce<hw>]:CORRection:CSET:DATA:POWer:POINts?.....	331
[:SOURce<hw>]:CORRection:CSET:DATA[:SENSor<ch>][:POWer]:SONCe.....	331
[:SOURce<hw>]:CORRection:CSET[:SELEct].....	335
[:SOURce<hw>]:CORRection:DEXChange:AFILe:CATalog?.....	332
[:SOURce<hw>]:CORRection:DEXChange:AFILe:EXTension.....	332
[:SOURce<hw>]:CORRection:DEXChange:AFILe:SELEct.....	332
[:SOURce<hw>]:CORRection:DEXChange:AFILe:SEParator:COLumn.....	333
[:SOURce<hw>]:CORRection:DEXChange:AFILe:SEParator:DECimal.....	333
[:SOURce<hw>]:CORRection:DEXChange:EXECute.....	334
[:SOURce<hw>]:CORRection:DEXChange:MODE.....	334
[:SOURce<hw>]:CORRection:DEXChange:SELEct.....	335
[:SOURce<hw>]:CORRection:VALue?.....	336
[:SOURce<hw>]:CORRection:ZERoing:STATe.....	336
[:SOURce<hw>]:CORRection[:STATe].....	336
[:SOURce<hw>]:FM:EXTernal:COUPling.....	337
[:SOURce<hw>]:FM:EXTernal:DEViation.....	338
[:SOURce<hw>]:FM:INTernal:DEViation.....	338
[:SOURce<hw>]:FM:MODE.....	338
[:SOURce<hw>]:FM:SENSitivity?.....	339
[:SOURce<hw>]:FM:SOURce.....	339
[:SOURce<hw>]:FM:STATe.....	340
[:SOURce<hw>]:FM[:DEViation].....	337
[:SOURce<hw>]:FREQuency:CENTer.....	341
[:SOURce<hw>]:FREQuency:MANual.....	342
[:SOURce<hw>]:FREQuency:MODE.....	343
[:SOURce<hw>]:FREQuency:MULTiplier.....	344

[:SOURce<hw>]:FREQuency:OFFSet.....	344
[:SOURce<hw>]:FREQuency:SPAN.....	345
[:SOURce<hw>]:FREQuency:STARt.....	345
[:SOURce<hw>]:FREQuency:STEP:MODE.....	347
[:SOURce<hw>]:FREQuency:STEP[:INCRement].....	346
[:SOURce<hw>]:FREQuency:STOP.....	346
[:SOURce<hw>]:FREQuency[:CW FIXed].....	341
[:SOURce<hw>]:FREQuency[:CW FIXed]:RCL.....	342
[:SOURce<hw>]:INPut:MODext:IMPedance.....	347
[:SOURce<hw>]:INPut:MODext:WIGNore.....	348
[:SOURce<hw>]:LFOutput:FREQuency:MANual.....	350
[:SOURce<hw>]:LFOutput:FREQuency:MODE.....	350
[:SOURce<hw>]:LFOutput:FREQuency:STARt.....	351
[:SOURce<hw>]:LFOutput:FREQuency:STOP.....	351
[:SOURce<hw>]:LFOutput:SWEep[:FREQuency]:DWELl.....	352
[:SOURce<hw>]:LFOutput:SWEep[:FREQuency]:EXECute.....	352
[:SOURce<hw>]:LFOutput:SWEep[:FREQuency]:MODE.....	353
[:SOURce<hw>]:LFOutput:SWEep[:FREQuency]:POINts.....	353
[:SOURce<hw>]:LFOutput:SWEep[:FREQuency]:RETRace.....	354
[:SOURce<hw>]:LFOutput:SWEep[:FREQuency]:RUNNING?.....	355
[:SOURce<hw>]:LFOutput:SWEep[:FREQuency]:SHAPE.....	355
[:SOURce<hw>]:LFOutput:SWEep[:FREQuency]:SPACing.....	355
[:SOURce<hw>]:LFOutput:SWEep[:FREQuency]:STEP:LOGarithmic.....	357
[:SOURce<hw>]:LFOutput:SWEep[:FREQuency]:STEP[:LINear].....	356
[:SOURce<hw>]:LIST:CATalog?.....	360
[:SOURce<hw>]:LIST:DELeTe.....	360
[:SOURce<hw>]:LIST:DELeTe:ALL.....	361
[:SOURce<hw>]:LIST:DEXChange:AFILe:CATalog?.....	361
[:SOURce<hw>]:LIST:DEXChange:AFILe:EXTension.....	362
[:SOURce<hw>]:LIST:DEXChange:AFILe:SELeCt.....	362
[:SOURce<hw>]:LIST:DEXChange:AFILe:SEParator:COLumn.....	363
[:SOURce<hw>]:LIST:DEXChange:AFILe:SEParator:DECimal.....	363
[:SOURce<hw>]:LIST:DEXChange:EXECute.....	363
[:SOURce<hw>]:LIST:DEXChange:MODE.....	364
[:SOURce<hw>]:LIST:DEXChange:SELeCt.....	364
[:SOURce<hw>]:LIST:DWELl.....	365
[:SOURce<hw>]:LIST:FREE?.....	365
[:SOURce<hw>]:LIST:FREQuency.....	365
[:SOURce<hw>]:LIST:FREQuency:POINts?.....	366
[:SOURce<hw>]:LIST:INDeX.....	366
[:SOURce<hw>]:LIST:INDeX:STARt.....	367
[:SOURce<hw>]:LIST:INDeX:STOP.....	367
[:SOURce<hw>]:LIST:LEARn.....	368
[:SOURce<hw>]:LIST:MODE.....	368
[:SOURce<hw>]:LIST:POWEr.....	368
[:SOURce<hw>]:LIST:POWEr:POINts?.....	369
[:SOURce<hw>]:LIST:RESEt.....	369
[:SOURce<hw>]:LIST:SELeCt.....	370
[:SOURce<hw>]:LIST:TRIGger:EXECute.....	370
[:SOURce<hw>]:LIST:TRIGger:SOURce.....	370

[[:SOURce<hw>]:MODulation[:ALL]][:STATe].....	371
[[:SOURce<hw>]:PGENerator:STATe.....	372
[[:SOURce<hw>]:PHASe.....	372
[[:SOURce<hw>]:PHASe:REFerence.....	373
[[:SOURce<hw>]:PM:EXTernal:COUpling.....	373
[[:SOURce<hw>]:PM:EXTernal:DEViation.....	374
[[:SOURce<hw>]:PM:INTernal:DEViation.....	374
[[:SOURce<hw>]:PM:MODE.....	375
[[:SOURce<hw>]:PM:SENSitivity?.....	375
[[:SOURce<hw>]:PM:SOURce.....	375
[[:SOURce<hw>]:PM:STATe.....	376
[[:SOURce<hw>]:PM[:DEViation].....	373
[[:SOURce<hw>]:POWer:ALC:OMODE.....	377
[[:SOURce<hw>]:POWer:ALC:SONCe.....	377
[[:SOURce<hw>]:POWer:ALC[:STATe].....	377
[[:SOURce<hw>]:POWer:ATTenuation:RFOff:MODE.....	378
[[:SOURce<hw>]:POWer:EMF:STATe.....	378
[[:SOURce<hw>]:POWer:LIMit[:AMPLitude].....	380
[[:SOURce<hw>]:POWer:LMODE.....	381
[[:SOURce<hw>]:POWer:MANual.....	382
[[:SOURce<hw>]:POWer:MODE.....	382
[[:SOURce<hw>]:POWer:POWer.....	383
[[:SOURce<hw>]:POWer:SPC:CRANge.....	383
[[:SOURce<hw>]:POWer:SPC:DELay.....	384
[[:SOURce<hw>]:POWer:SPC:PEAK.....	384
[[:SOURce<hw>]:POWer:SPC:SElect.....	384
[[:SOURce<hw>]:POWer:SPC:STATe.....	385
[[:SOURce<hw>]:POWer:SPC:TARGet.....	385
[[:SOURce<hw>]:POWer:STARt.....	385
[[:SOURce<hw>]:POWer:STEP:MODE.....	386
[[:SOURce<hw>]:POWer:STEP[:INCRement].....	386
[[:SOURce<hw>]:POWer:STOP.....	387
[[:SOURce<hw>]:POWer[:LEVel][:IMMediate]:OFFSet.....	379
[[:SOURce<hw>]:POWer[:LEVel][:IMMediate]:RCL.....	380
[[:SOURce<hw>]:POWer[:LEVel][:IMMediate][:AMPLitude].....	379
[[:SOURce<hw>]:PULM:DELay.....	390
[[:SOURce<hw>]:PULM:DOUble:DELay.....	391
[[:SOURce<hw>]:PULM:DOUble:STATe.....	391
[[:SOURce<hw>]:PULM:DOUble:WIDTh.....	391
[[:SOURce<hw>]:PULM:MODE.....	391
[[:SOURce<hw>]:PULM:OUTPut:SYNC[:STATe].....	392
[[:SOURce<hw>]:PULM:PERiod.....	392
[[:SOURce<hw>]:PULM:POLarity.....	393
[[:SOURce<hw>]:PULM:SOURce.....	393
[[:SOURce<hw>]:PULM:STATe.....	394
[[:SOURce<hw>]:PULM:TRAIIn:CATalog?.....	394
[[:SOURce<hw>]:PULM:TRAIIn:DELete.....	394
[[:SOURce<hw>]:PULM:TRAIIn:DEXChange:AFILe:CATalog?.....	400
[[:SOURce<hw>]:PULM:TRAIIn:DEXChange:AFILe:EXTension.....	401
[[:SOURce<hw>]:PULM:TRAIIn:DEXChange:AFILe:SElect.....	401

[:SOURce<hw>]:PULM:TRAI:n:DEXChange:AFILe:SEPARator:COLumn.....	402
[:SOURce<hw>]:PULM:TRAI:n:DEXChange:AFILe:SEPARator:DECimal.....	402
[:SOURce<hw>]:PULM:TRAI:n:DEXChange:EXECute.....	403
[:SOURce<hw>]:PULM:TRAI:n:DEXChange:MODE.....	403
[:SOURce<hw>]:PULM:TRAI:n:DEXChange:SELEct.....	404
[:SOURce<hw>]:PULM:TRAI:n:OFFTime.....	395
[:SOURce<hw>]:PULM:TRAI:n:OFFTime:POINts?.....	395
[:SOURce<hw>]:PULM:TRAI:n:ONTime.....	396
[:SOURce<hw>]:PULM:TRAI:n:ONTime:POINts?.....	396
[:SOURce<hw>]:PULM:TRAI:n:REPetition.....	397
[:SOURce<hw>]:PULM:TRAI:n:REPetition:POINts?.....	397
[:SOURce<hw>]:PULM:TRAI:n:SELEct.....	398
[:SOURce<hw>]:PULM:TRIGger:EXTernal:GATE:POLarity.....	398
[:SOURce<hw>]:PULM:TRIGger:EXTernal:IMPedance.....	399
[:SOURce<hw>]:PULM:TRIGger:EXTernal:SLOPe.....	399
[:SOURce<hw>]:PULM:TRIGger:MODE.....	399
[:SOURce<hw>]:PULM:WIDTh.....	404
[:SOURce<hw>]:SWEep:POWer:DWELI.....	425
[:SOURce<hw>]:SWEep:POWer:EXECute.....	425
[:SOURce<hw>]:SWEep:POWer:MODE.....	425
[:SOURce<hw>]:SWEep:POWer:POINts.....	426
[:SOURce<hw>]:SWEep:POWer:RETRace.....	427
[:SOURce<hw>]:SWEep:POWer:RUNNing?.....	427
[:SOURce<hw>]:SWEep:POWer:SHAPE.....	427
[:SOURce<hw>]:SWEep:POWer:SPACing:MODE?.....	428
[:SOURce<hw>]:SWEep:POWer:STEP[:LOGarithmic].....	428
[:SOURce<hw>]:SWEep:RESEt[:ALL].....	429
[:SOURce<hw>]:SWEep[:FREQuency]:DWELI.....	418
[:SOURce<hw>]:SWEep[:FREQuency]:EXECute.....	419
[:SOURce<hw>]:SWEep[:FREQuency]:LFCOnnector.....	419
[:SOURce<hw>]:SWEep[:FREQuency]:MODE.....	419
[:SOURce<hw>]:SWEep[:FREQuency]:OVOLtage:STARt.....	420
[:SOURce<hw>]:SWEep[:FREQuency]:OVOLtage:STOP.....	421
[:SOURce<hw>]:SWEep[:FREQuency]:POINts.....	421
[:SOURce<hw>]:SWEep[:FREQuency]:RETRace.....	422
[:SOURce<hw>]:SWEep[:FREQuency]:RUNNing?.....	422
[:SOURce<hw>]:SWEep[:FREQuency]:SHAPE.....	422
[:SOURce<hw>]:SWEep[:FREQuency]:SPACing.....	423
[:SOURce<hw>]:SWEep[:FREQuency]:STEP:LOGarithmic.....	424
[:SOURce<hw>]:SWEep[:FREQuency]:STEP[:LINear].....	423
*CLS.....	280
*ESE.....	280
*ESR?.....	280
*IDN?.....	281
*IST?.....	281
*OPC.....	281
*OPT?.....	281
*PRE.....	282
*PSC.....	282
*RCL.....	282

*RST.....	282
*SAV.....	283
*SRE.....	283
*STB?.....	283
*TRG.....	283
*TST?.....	283
*WAI.....	284
SENSe<ch>[:POWer]:SNUMber?.....	322
SENSe<ch>[:POWer]:STATus[:DEVice]?.....	323
SENSe<ch>[:POWer]:SVERsion?.....	323
SENSe<ch>[:POWer]:TYPE?.....	324
STEReo:DIRect.....	456
STEReo:DIRect.....	457
STEReo:DIRect.....	458
STEReo:DIRect.....	458
STEReo:DIRect.....	459
STEReo:DIRect.....	459
STEReo:DIRect.....	460
STEReo:DIRect.....	460
STEReo:DIRect.....	460
STEReo:DIRect.....	461
STEReo:DIRect.....	461
STEReo:DIRect.....	461
STEReo:DIRect.....	461
STEReo:DIRect.....	462
STEReo:DIRect.....	463
STEReo:DIRect.....	463
STEReo:DIRect.....	463
STEReo:DIRect.....	464
STEReo:DIRect.....	464
STEReo:DIRect.....	465
STEReo:DIRect.....	465
STEReo:DIRect.....	465
STEReo:DIRect.....	465
STEReo:DIRect.....	466
STEReo:DIRect.....	466
STEReo:DIRect.....	467
STEReo:DIRect.....	468
STEReo:DIRect.....	468
STEReo:DIRect.....	468
STEReo:DIRect.....	469
STEReo:DIRect.....	469
STEReo:DIRect.....	469
STEReo:DIRect.....	470
STEReo:DIRect.....	470
STEReo:DIRect.....	470
STEReo:DIRect.....	471
STEReo:DIRect.....	471
STEReo:DIRect.....	471
STEReo:DIRect.....	472
STEReo:DIRect.....	472
STEReo:DIRect.....	473
STEReo:DIRect.....	473

STEReo:DIrect.....	473
STEReo:DIrect.....	473
STEReo:DIrect.....	474
STEReo:DIrect.....	475
STEReo:DIrect.....	475
STEReo:DIrect.....	476
STEReo:DIrect.....	476
STEReo:DIrect.....	476
STEReo:DIrect?.....	475

Index

Symbols

*OPC	268
*OPC?	268
*RST	277
*WAI	268
/var directory	302
>L	245
>R	245
&LLO	245
10 - Hardware failure	487
11 - DSP failure	487
12 - IIC bus error	487
13 - Real time clock error	487
50 - Extern reference out of range or disconnected	486
100 - Software failure	487
101 - DSP mailbox timeout	487
102 - DSP overflow	487
120 - RDS error	487
121 - PI error	487
122 - PSN error	487
123 - Buffer overflow	487
124 - Dataset empty	487
140 - This modulation forces other modulations off	486
180 - Adjustment failed	486
182 - Adjustment data missing	486
183 - Adjustment data invalid	486
200 - Cannot access hardware	486
201 - Hardware revision out of date	486
202 - Cannot access the EEPROM	486
203 - Invalid EEPROM data	486
204 - river initialization failed	486
241 - No current list	486
242 - Unknown list type specified	486
460 - Cannot open file	487
461 - Cannot write file	487
462 - Cannot read file	487
463 - Filename missing	487
464 - Invalid filename extension	487
465 - File contains invalid data	487

A

Abort button	79
Abort calculation	79
AC supply	22
Accept	
Security Settings	120
Access denied	72
Address mode	
Network settings	106
Adjust All	93
Adjust Analog Channels	94, 288
Adjust FM Offset	286
Adjust Level	94
Adjust Synthesis	93
Adjust Synthesis Extension	93
Adjustment active	
Reference oscillator	144
Adjustment Data	151
Adjustment frequency	
Reference oscillator	144

Adjustments

All	93
ALC (automatic level control)	151, 377
ALC Auto	483
ALC On	151, 483
ALC S&H	483
ALC Table	483
AM Depth	200
AM External Coupling	201
AM Sensitivity	201
AM Source	199
AM State	199
AM Type	
amplitude modulation	200
Amplitude	
Annotation (setup security)	118
Amplitude modulation	
AM type	200
Analog modulation	
Ignore overvoltage warning	202, 205, 209
Annotation	
Amplitude (security)	118
Frequency (security)	118
Aperture time	
Power sensors	173
Application cards	14
Application notes	14
Applications of the R&S SMB	56
Architecture of the instrument	54
ARI BK Code	216, 408
ARI Deviation	216
ARI Identification	216, 409
ARI State	216, 409
Arrow keys	19
ASCII file import/export	
List Mode	187
Assemblies display	94
ATN	490
Attention	490
Attenuator Mode	149
Attenuator Settings	
Fixed Range (PEP) in	149
mode	149
RF OFF Mode	150
AttFixed	484
AUDio Identification	410
Audio Source	416
Stereo modulation	213
Auto once	
Power Sensors	173
Auto Once - Power Sensors	320
Auto-negotiation	
see Autonegotiation	35
Autonegotiation	
Failed	487
Failure	35
Avahi	
LAN Services	117

B

Baudrate	
RS232 interface	109

- Bluetooth
 - RS232 Interface 109
- Bluetooth Pin 120
- Boolean parameters 263
- Brochure 13
- Browser settings
 - LXI 46
- Buffer overflow (123) 487
- BUSY 482
- C**
- Case-sensitivity
 - SCPI 259
- Catch range
 - NRP-Z level control 157
 - NRP-Z power control 383
- Center Freq 179
- Change password
 - Setup (security) 116
- Check front panel 101
 - Performing 102
 - Settings 101
- Clear status
 - Remote 280
- Closed loop power control
 - see NRP-Z level control 154
- CLPC
 - see NRP-Z level control 154
- Colon 264
- Column Separator Import/Export
 - Pulse Train data 234
- Column Separator Import/Export - User Correction data 162
- Comma 264
- Command sequence
 - recommendation 277
 - Remote 284
- Commands 237
 - Colon 264
 - Comma 264
 - Command line structure 264
 - Common 237
 - Double dagger 264
 - GBIP, addressed 243
 - GBIP, universal 242
 - Instrument control 237
 - Overlapping 266
 - Question mark 264
 - Quotation mark 264
 - SCPI confirmed 237
 - Sequential 266
 - Syntax elements 264
 - White space 264
- Common commands
 - Syntax 258
- Computer name
 - Changing 37
 - see hostname 105
 - use instead of IP address 36
- CONDition 272
- Confirm user password
 - Setup (security) 116
- Connection fault
 - 169.254.* * 487
- Connection to an external controller 37
- Connector
 - GPIB 23
 - IEC/IEEE 23
 - INSTR TRIG 23
 - LAN 23
 - LF 20
 - MOD EXT 20
 - PULSE EXT 23
 - PULSE VIDEO 23
 - REF IN 24
 - REF OUT 24
 - RF 21
 - S/P DIF 23
 - SIGNAL VALID 23
 - Stereo R/L 23
 - USB type A 22
 - USB type B 22
- Control bus 490
- Controller, external 37
- Copy
 - Several files 132
- Copy instrument settings 131
- Counter 94, 289, 290
- Coupling mode 205
- Coupling mode - EXT MOD (AM) 201
- Create New Directory 132
- Current Freq (LF Sweep) 224
- Current Freq (RF Sweep) 179
- Current Index
 - List Mode 191
- Current Level 186
- Current Sensors 97
- Cursor keys 19
- Cut 131
- D**
- Data sheet 13
- Data Valid 490
- Dataset empty (124) 487
- Date
 - Setup 103
- DAV 490
- DCL 242
- Deactivate RF output 143
- Decimal Point Import/Export
 - Pulse Train data 234
- Decimal Point Import/Export - List Mode data 194
- Decimal Point Import/Export - User Correction data 162
- DEF 262
- Default gateway
 - Network settings 106
- Default instrument settings 30, 91, 285
- Default values
 - Remote 282
- Delay
 - Double pulse 228
 - Pulse generator 228
- Delay time
 - NRP-Z level control 157
 - NRP-Z power control 384
- Delete instrument settings 132, 309
- Delta Phase 141
- Destination - Hardcopy 122
- Destination Import/Export
 - Pulse Train data 234
 - User Correction data 162

- Destination Import/Export - List Mode data 195
- Deviation
 - Stereo modulation 213
- Device ID 97
- Device-specific commands 237
- Device-specific error messages 485
- DHCP 36
- Direct programming 412
- Display 67
 - Lock (security) 118
- Display priority
 - Power sensors 170
- DISPlay subsystem 290
- DNS server
 - Network settings 107
- DNS suffix
 - Network settings 106
- Documentation overview 13
- Double dagger 264
- Double Pulse 227
- Double pulse delay
 - Pulse generator 228
- Double pulse width
 - Pulse generator 228
- DOWn 262
- DSP failure (11) 487
- DSP mailbox timeout (101) 487
- DSP overflow (102) 487
- Dwell time
 - RF sweep 181
- Dwell Time 187, 190, 225
 - List Mode 190
- E**
- Edit
 - Pulse Train 232
- Edit Pulse Train Data 231
- Edit User Correction Data 159
- EFC mode (Electronic Frequency Control) 143
- Electrostatic discharge 25
- EMF - Level display 151
- EMI suppression 25
- Emulation
 - IDN string 111
 - Language 111
 - Mode 111
 - Set IDN and OPT to default 111
- Enable
 - LAN interface 117
- ENABle 272
- Enable registers
 - Remote 282
- Enter License Key 97
- EOI 490
- Error log 488
- Error messages 69, 481
 - Adjustment data invalid (183) 486
 - Adjustment data missing (182) 486
 - Adjustment failed (180) 486
 - Cannot access hardware (200) 486
 - Cannot access the EEPROM (202) 486
 - Cannot open file (460) 487
 - Cannot read file (462) 487
 - Cannot write file (461) 487
 - Driver initialization failed (204) 486
 - Extern reference out of range or disconnected (50) 486
 - File contains invalid data (465) 487
 - Filename missing (463) 487
 - Hardware revision out of date (201) 486
 - Invalid EEPROM data (203) 486
 - Invalid filename extension (464) 487
 - No current list (241) 486
 - This modulation forces other modulations off (140) 486
 - Unknown list type specified (242) 486
- Error Messages 484
 - device-specific 485
 - SCPI 485
- Error messages - display list 436
- Error queue 273
- Error queue query 434, 435
- Error queues
 - recommendations 278
- ESD 25
- ESE (event status enable register) 274
- ESR 270
- ESR (event status register) 274
- EVENT 272
- Event status enable register (ESE) 274
 - Remote 280
- Event status register (ESR) 274
 - Remote 280
- Exclude Frequency 129
- Exclude Level 129
- Execute
 - Single trigger 229
- Execute Single
 - List Mode 190
- Execute single sweep
 - Frequency sweep 178
- Execute Single Sweep
 - Level Sweep 185
- Execute Single Sweep - LF Sweep 223
- Expiration date of option 96
- Export Deactivation Response 97
- EXT REF 482
- Extension Import/Export
 - Pulse Train data 233
- Extension Import/Export - List Mode data 194
- Extension Import/Export - User Correction data 162
- External frequency
 - Reference oscillator 144
- External impedance
 - Pulse generator 229
- External Impedance
 - Stereo modulation 214
- External input impedance 229
- External modulation signal 198
 - FM 202
 - ϕ M 206
- External modulation signal - voltage 198
- External Reference Frequency 405
- F**
- Factory preset 120
- Failure
 - Network connection 35
- Features of R&S SMB 56
- File - Hardcopy dialog 122
- File list 306
- File menu
 - Save/Recall 127
- File Name - Hardcopy 123

- File setup - Hardcopy 123
 - File type selection 131
 - Fill Table
 - List Mode 192
 - Fill Table - List mode 195
 - Fill Table From 195
 - Fill Table Range 163, 195
 - Filter
 - Low harmonic 148
 - mode (low harmonic) 149
 - Power Sensors 171
 - State (low harmonic) 149
 - Filter Length
 - Power Sensors 171
 - Filter Length - Power Sensors 318, 319, 320
 - Firmware version 96
 - Floating licenses 96
 - FM deviation 204
 - FM Deviation
 - Stereo modulation 213
 - FM external coupling 205
 - FM mode 203
 - FM sensitivity 204
 - FM source 203
 - FM state 203
 - FM-DC mode 141
 - FREQ OFFSET 481
 - Frequency 145
 - Annotation (setup security) 118
 - LF generator 200, 204, 208, 214, 219
 - List Mode 192
 - Multiplier 139
 - PM 228
 - Power sensors 171
 - RF signal 137
 - Set Frequency 138
 - Stereo modulation 214
 - Frequency - RF sweep 178, 179
 - Frequency (status bar)
 - RF signal 138
 - Frequency dialog
 - RF signal 138
 - Frequency display 67
 - Front panel key emulation 87
 - Front panel test
 - Performing 102
 - FTP
 - How to 132
 - LAN Services 117
 - Fuses 28
- G**
- Gate input polarity 229
 - Gated
 - Pulse trigger input 229
 - Gated signal
 - Pulse modulation 228
 - Gateway 106
 - GET 243
 - Getting started 54
 - Goto local
 - Remote channel settings 110
 - GPIB 110
 - bus address 109
 - Characteristics 241
 - interface messages 242
 - Remote control interface 235
 - GPIB address 243
 - GTL 243
 - GUI Language 108
- H**
- Hardcopy - Destination 122
 - Hardcopy - File setup 123
 - Hardcopy dialog - File 122
 - Hardware Config 94
 - Hardware failure (10) 487
 - Hardware options 95
 - HiSLIP
 - Protocol 239
 - Resource string 238
 - Host name
 - see Computer name 36, 37
 - Hostname
 - Network settings 105
 - see Computer name 36, 37
 - HTTP
 - LAN Services 117
- I**
- Identification
 - Emulation mode 111
 - Remote 281
 - Identification mode 111
 - IDN string
 - Emulation 111
 - Emulation mode 111
 - IFC 242, 490
 - Ignore level warning
 - Level 148
 - Ignore overvoltage warning
 - Analog modulation 202, 205, 209
 - IIC bus error (12) 487
 - Impedance
 - External input 201, 205, 209
 - Impedance Audio Signal 214
 - Import License Key 97
 - Import/Export
 - List Mode data 195
 - Pulse Train data 233, 234
 - User Correction data 161, 162
 - Import/Export - List Mode data 193
 - INF 262
 - INFO key 69
 - Input
 - Stereo Modulation 211
 - Input connector 20, 23, 24
 - Installed Assembly 95
 - Instrument Config 94
 - Instrument Emulations 110
 - Instrument messages 236
 - Instrument settings
 - Recall 128, 282, 309
 - Save 127, 283, 311
 - Instrument Trigger 182, 187, 193, 226
 - Interface
 - functions (GPIB bus) 491
 - Interface Clear 490
 - Interface messages 236, 240

- Interfaces
 - GPIB 241
 - USB 240
- Internal adjustments
 - Setup 92
- Interrupt 275
- IP address 238
 - Changing 36
 - Network settings 106
 - Not recognized 487
- IP address mode 106
- IST 270
- IST flag
 - Remote 281
- K**
- Key
 - Arrow key 20
 - BACKSPACE 18
 - Cursor key 20
 - DIAGRAM 18
 - ENTER 19
 - ESC 18
 - FILE 16, 126
 - FREQ 17
 - HELP 16
 - INFO 16
 - LEVEL 17
 - LOCAL 16
 - MOD ON/OFF 18, 197
 - ON/OFF TOGGLE 17
 - PRESET 16, 30, 91
 - RF ON/OFF 18
 - SETUP 16, 91
 - WINBAR 16
- Key - HELP 125
- Key - LOCAL 121
- Key combinations 86
- Keyboard
 - Layout 108
- Keyboard Language 302
- Keypad 18
- Keywords
 - see Mnemonics 258
- L**
- LAN
 - Configuration 34
 - Interface 237
 - IP address 238
 - Remote control interface 235
 - VISA 238
 - VXI protocol 239
- LAN connection
 - Not working 35
- LAN interface
 - Avahi 117
 - enable 117
 - FTP 117
 - HTTP 117
 - LAN over SCPI 117
 - SMB (Samba) 117
 - SSH 117
 - VNC 117
- LAN Interface
 - Services 116
 - Setup 116
- LAN Status - LXI 112
- Language
 - Emulation 111
- Language Keyboard 302
- Layout
 - Keyboard 108
- Learn List Mode Data 191
- Level 146
 - Ignore level warning 148
 - limit 147, 157
 - Power sensors 169
 - RF output 147
 - uninterrupted setting 149
- Level - Step width 150
- Level (Avg.)
 - Power sensors 169
- Level control 151, 377
- Level display 67
- Level display EMF 151
- Level limit
 - RF level 147, 157
- Level offset 148
 - Power Sensors 171
 - State (power sensors) 171
- LEVEL OFFSET 482
- Level Sweep 182
- Level user correction 158
- LevelSweep 483
- LF frequency sweep
 - Retrace 225
- LF gen frequency 200, 204, 208, 219
- LF gen shape 201, 204, 208, 220
- LF Gen Voltage 219
- LF generator 218
 - Frequency 200, 204, 208, 219
 - Shape 201, 204, 208, 220
- LF output 218
- LF Output
 - State 219
 - Sweep voltage 181, 182
- LF output - Source Impedance 220
- LF Source Impedance 220
- LF sweep
 - Step lin 225
 - Step log 225
 - Step width 225
- LF Sweep 224
- LFGen Frequency 214
- LFSweep 483
- License for software option 96
- License Key 96
- Limit
 - Level 147, 157
- Linux 33
- Linux controller 40
- List mode 187
 - manual processing of lists 189
- List Mode Data 191
- List Range In 193
- ListMode 484
- LLO 242
- Load instrument settings 128, 282, 309
- LOC-LLO 483
- Local to remote switchover 244, 245

Lock	
Display (setup security)	118
Low harmonic	
Filter	148
Filter mode	149
Filter state	149
LXI	112
Browser interface	46
Browser settings	46
Configuration	45
LAN configuration	47
Ping	49
Remote trace (SCPI)	51
Web Control	50
M	
Mac address	107
Maintenance	92
Malfunctions	
reacting	278
Manual Remote Control	37
MAX	262
Max Modulation Freq	215
Maximum deviation	207
FM	204
Measured level	
NRP-Z level control	156
Menu structure	
Access denied	72
Header	71
Menu area	72
Messages	
Commands	237
Instrument	236
Instrument responses	237
Interface	236
MIN	262
Mnemonics	258
Optional	260
Mod Gen block	57
MOD OFF	481
MOD ON/OFF Key	197
Mode	
Emulation	111
FM	203
Level Sweep	183
LF Gen	221
LF sweep	221
List Mode	189
Low harmonic filter	149
Pulse generator	227
ϕ M	207
RF frequency sweep	176
RF level	147
Mode Import/Export	
Pulse Train data	233
Mode Import/Export - List Mode data	194
Mode Import/Export - User Correction data	161
Modulation	
AM	198
FM	202
PM	209
Pulse modulation	209
ϕ M	206
Stereo modulation	211
Modulation depth - AM	200
Modulation deviation	
FM	204
ϕ M	207
MPX Deviation	213
Multi transmitter measurements	151
Multiple files	
Copy	132
Multiplier	
Frequency	139
N	
NAN	262
Navigation keys	19
NDAC	490
Network	
Connection fails	487
Network connection	
Error	35
Network settings	104
Address mode	106
Default gateway	106
DNS server	107
DNS suffix	106
Hostname	105
IP address	106
Status	105
Subnet mask	106
Workgroup	105
Network status	105
New password	
Setup (security)	116
New user password	
Setup (security)	116
NINF	262
No-load voltage (EMF)	151
NRFD	490
NRP-Z Info	97
NRP-Z level control	154
catch range	157
delay time	157
measured level	156
sensor	156
state	156
target level	157
use peak power	157
NRP-Z power control	
catch range	383
delay time	384
RF level limit	147, 157
sensor	384
state	385
target level	385
use peak power	384
use SParameter	157, 173
NRP-Z power viewer	
use SParameter	157, 173
NTransition	272
Number of licenses	96
Numeric values	
Special	262
O	
OCXO	24
Off time	
Pulse Train	232

- Offset
 - RF signal 139
 - Offset - Level 148
 - Old password
 - Setup (security) 116
 - Old user password
 - Setup (security) 116
 - On time
 - Pulse Train 232
 - Online help 13
 - Working with 81
 - Online manual 13
 - Open source acknowledgment 14
 - Operating concept 54
 - Operating manual 13
 - Operating system 33
 - Operation complete
 - Remote 281
 - Operation hours 94, 289, 290
 - OPT String 111
 - Option
 - Hardware 95
 - Software 95
 - Option: expiration date 96
 - Options
 - Identification (remote) 281
 - Options - Hardcopy 122
 - OSA 14
 - Oscillator
 - Reference 141
 - Source (reference) 143
 - Output
 - LF 218
 - Output connector 20, 21, 23, 24
 - Output queue 270
 - Output Voltage - LF output 219
 - Output voltage start 181
 - Output voltage stop 182
 - OvenCold 484
 - Overlapping commands 266
 - Preventing 268
 - Overload 165
 - OVERLOAD 482
- P**
- Packing 480
 - Parallel poll register enable
 - Remote 282
 - Parameters
 - Block data 264
 - Boolean 263
 - SCPI 261
 - Special numeric values 262
 - String 264
 - Text 263
 - Units 262
 - Parity
 - RS232 interface 109
 - Part numbers 94
 - Password
 - Change (security password) 116
 - Confirm (security password) 116
 - Confirm (user password (security)) 116
 - New (security password) 116
 - New (user password (security)) 116
 - Old (security password) 116
 - Paste 131
 - PCI bus 95
 - Period
 - Pulse generator 228
 - Permanent display
 - Power sensors 170
 - Phase
 - RF signal 140, 141
 - PhiM
 - see ϕM 206
 - PI error (121) 487
 - Pilot Deviation 215
 - Pilot Phase 215
 - Pilot State 215, 414
 - Ping
 - LXI 49
 - Point-to-point connection 35
 - Polarity
 - Pulse Modulation 211
 - Power
 - List Mode 192
 - Power sensors
 - Aperture time 173
 - Auto once 173
 - Display priority 170
 - Filter 171
 - Frequency 171
 - Level 169
 - Level (Avg.) 169
 - Level offset 171
 - NRP-Z level control 154
 - Permanent display 170
 - Power viewer 168
 - Source 171
 - State 169
 - State (level offset) 171
 - Type 169
 - Unit 169
 - Use default aperture time 173
 - zero 156, 170
 - Power-On Count 94, 95
 - Power-On Counter 290
 - Power-On State 151
 - PPC 243
 - PPE 270
 - PPU 242
 - Preemphasis 214, 412
 - Preset 30
 - Preset - instrument settings 91
 - Preset instrument settings 30, 285
 - Protection 113
 - Protocol
 - VXI 239
 - PSN error (122) 487
 - PTRansition 272
 - Pulse delay
 - Pulse generator 228
 - Pulse external impedance 229
 - Pulse generator 226
 - Delay 228
 - Double pulse delay 228
 - Double pulse width 228
 - External impedance 229
 - Mode 227
 - Period 228
 - Settings 226
 - Signal valid as pulse sync 229

- Trigger mode 228
 - Video-Sync signal state 227
 - Width 228
 - Pulse Generator
 - Pulse Train 230
 - Pulse generator state 227
 - Pulse mode
 - Pulse generator 227
 - Pulse Mode 227
 - Pulse modulation 209
 - repetition frequency 228
 - Signal valid as pulse sync 229
 - Source 211
 - State 211
 - Trigger mode 228
 - Pulse period
 - Pulse generator 228
 - Pulse Train 227
 - Pulse Generator 230
 - Pulse Train Data 231
 - Pulse trigger input slope 229
 - Pulse width
 - Pulse generator 228
 - ϕ M
 - Mode 207
 - Modulation deviation 207
 - Source 207
 - ϕ M External Coupling 208
 - ϕ M Sensitivity 208
 - ϕ M State 207
- Q**
- Queries 237, 265
 - Status 276
 - Question mark 264, 265
 - Questionable status register 274, 275
 - Quick start guide 13
 - Quotation mark 264
- R**
- Rackmounting 28
 - RDS Data Set 217, 414
 - RDS Deviation 217
 - RDS error (120) 487
 - RDS Program Identification 217
 - RDS Program Service Name 217
 - RDS State 216, 414
 - RDS Traffic Announcement 218, 415
 - RDS Traffic Program 217, 415
 - Real time clock error (13) 487
 - Recall instrument settings 128, 129, 282, 309
 - Recall intermediate 282
 - Recall Intermediate 130
 - Recommendations
 - remote control programming 277
 - Reference
 - Source (oscillator) 143
 - Reference frequency
 - External 144
 - Reference frequency - external 405
 - Reference oscillator 141
 - Adjustment active 144
 - Adjustment frequency 144
 - External frequency 144
 - RF off state 143
 - Settings 143
 - Source 143
 - synchronization bandwidth 144
 - Registers 270
 - Release notes 14
 - REM-LLO 483
 - Remote
 - Bluetooth 109
 - RS232 109
 - REMOTE 483
 - Remote access 37
 - Remote channel
 - GPIB address 109
 - Remote channel settings 108
 - Goto local 110
 - GPIB resource (VISA resource string) 110
 - HILIP resource (VISA resource string) 110
 - Network resource (Ethernet resource string) 110
 - Serial 110
 - Socket resource (VISA resource string) 110
 - USB VISA resource string 110
 - Remote connection
 - Not working 35
 - Remote control
 - Basics 235
 - GPIB address 243
 - Interfaces 235
 - Protocols 235
 - Remote Control
 - GPIB 246
 - Remote control switchover 244
 - Remote trace
 - LXI 51
 - Removing sensitive data 488
 - REN 490
 - Rename 132
 - File 310
 - Repetition
 - Pulse Train 232
 - Reset 178
 - List Mode 190
 - Reset - RF sweep 178
 - Reset Delta Phase Display 141
 - Reset instrument settings 30, 91, 285
 - Reset values
 - Remote 282
 - Resolving network problems 107
 - Restart network
 - Setting 107
 - Retrace
 - LF frequency sweep 225
 - RF frequency sweep 180
 - RF level sweep 186
 - Reverse power protection 165
 - Revisions 94
 - RF block 58
 - RF During Power Search - ALC 153
 - RF frequency
 - Multiplier 139
 - Settings 138
 - RF Frequency
 - Set frequency (dialog) 139
 - RF frequency sweep
 - Retrace 180
 - RF frequency vs. RF output frequency 137
 - RF level
 - Mode 147

- RF Level
 - limit 147, 157
- RF level limit
 - NRP-Z power control 147, 157
- RF Level Sweep
 - Retrace 186
- RF OFF 135, 481
- RF off state
 - Reference oscillator 143
- RF ON 135
- RF ON/OFF key 135
- RF output
 - Power-on state 151
- RF Output 135
- RF output level 147
- RF output state 136
- RF signal
 - Frequency 137
 - Frequency dialog 138
 - Frequency offset 139
 - Multiplier 139
 - Offset 139
 - Phase 140
 - Phase adjustment 141
 - Set frequency (status bar) 138
 - User variation 140
- RF State 135
- RF sweep
 - Step lin 180
 - Step log 180
 - Step width 180
- RFSweep 483
- Rotary knob 19
- RS232
 - Baud rate 109
 - Parity 109
 - Serial interface 109
 - Stop bits 110
- Run Update 97
- S**
- Safety instructions 13
- SAMBA/SMB
 - How to 132
- Sample-and-Hold mode 377
- Sample&Hold mode 151
- Save immediate 127
- Save instrument settings 127, 283, 311
- Save intermediate 283
- SCPI
 - LAN Services 117
 - Parameters 261
 - Syntax 258
 - Version 236
- SCPI - error messages 485
- SCPI confirmed commands 237
- SCPI remote trace
 - LXI 51
- Screen Saver 108
- SDC 243
- Search Once - ALC 153
- Security
 - Accept settings 120
 - Annotation amplitude (setup) 118
 - Annotation frequency (setup) 118
 - Change password (setup) 116
 - Confirm password (setup) 116
 - Confirm user password (setup) 116
 - Display lock (setup) 118
 - New password (setup) 116
 - New user password (setup) 116
 - Old password (setup) 116
 - Security password 116
 - User interface 118
 - User password 115
- Security password
 - Security 116
 - Setup 116
- Security Password
 - Setup 120
- Security settings
 - LAN services 116
- Security Settings
 - Security Password 120
 - USB storage 118
 - User Name 115
 - Write nonvolatile memory 118
- Select ASCII Destination
 - Pulse Train data 234
 - User Correction data 162
- Select ASCII Destination - List Mode data 194
- Select ASCII Source
 - Pulse Train data 234
 - User Correction data 162
- Select List 191
- Select NRP File 97
- Select operation
 - File menu 127
- Select Pulse Train Data 231
- Select sensor
 - Power viewer 168
- Self-test
 - Remote 283
- Selftest 101
- Sensor
 - NRP-Z level control 156
 - NRP-Z power control 384
 - Power viewer 168
- Sequential commands 266
- Serial bus 95
- Serial interface
 - RS232 109
- Serial numbers 94
- Service manual 13
- Service request (SRQ) 273, 275
- Service request enable register (SRE) 273
 - Remote 283
- Set frequency
 - RF signal 139
- Set IDN and OPT to default
 - Emulation mode 111
- Setting commands 237
- Setting not possible 72
- Setting parameters 73
- Settings
 - Check front panel 101
 - Pulse generator 226
 - Reference oscillator 143
- Setup
 - Accept security settings 120
 - Annotation amplitude (security) 118
 - Annotation frequency (security) 118
 - Change password (security) 116

Confirm password (security)	116
Confirm password (user)	116
Date	103
Display lock (security)	118
Internal adjustments	92
LAN services	116
New password (security)	116
New password (user)	116
Old password (security)	116
Old password (user)	116
Performing the front panel test	102
Security password	116
Time	103
Timezone	104
User interface (security)	118
User password	115
Setup key	91
Shape	
LF generator	201, 204, 208, 214, 220
RF Level Sweep	186
Shape - LF Frequency Sweep	224
Shape - RF Sweep	179
Show level permanent - Power Sensors	318
Signal valid as pulse sync	
pulse generator	229
pulse modulation	229
Single Pulse	227
Single trigger	
Execute	229
Slope	
Pulse trigger input	229
SMB (Samba)	
LAN Services	117
SMZ Info	
FW-Version	99
MAX Freq	99
Min Freq	99
Revision	99
Serial number	99
Type	99
Software failure (100)	487
Software options	95
Source	
FM	203
Level Sweep Trigger	183
LF sweep trigger	221
List Mode	189
Power sensors	171
Pulse modulation	211
φM	207
Reference oscillator	143
RF frequency sweep trigger	176
Source - AM	199
Source - Power Sensors	323
Source impedance - LF output	220
Source Import/Export	
Pulse Train data	234
User Correction data	162
Spacing	
Level Sweep	187
Spacing - LF Sweep	224
Spacing - RF Sweep	179
Span (RF sweep)	179
SPD	242
SPE	242
Special characters	
SCPI	261
SRE	270
SRE (service request enable register)	273
SRQ	490
SRQ (service request)	273, 275
SSH	
LAN Services	117
Standby mode	16
Start	
Power Sensors	316
Start Freq	178
Start Freq - LF sweep	224
Start Level	185
Start/Stop Display Update	100
Startup complete	445
State	
Adjustment (reference oscillator)	144
ALC	153
LF Output	219
List mode	189
Low harmonic filter	149
NRP-Z level control	156
NRP-Z power control	385
Power sensors	169
Pulse modulation	211
φM	207
Stereo modulation	213, 416
Video-Sync signal	227
State - User Correction	159
Status	
Network settings	105
Queries	276
Status byte	
Remote	280, 283
Status byte (STB)	273
Status information	481
Status Information	97
status messages	
FREQ OFFSET	481
MOD OFF	481
OVERLOAD	482
RF OFF	481
Status messages	
ALC On	483
AttFixed	484
Auto	483
BUSY	482
EXT REF	482
LEVEL OFFSET	482
LevelSweep	483
LFSweep	483
ListMode	484
LOC-LLO	483
OvenCold	484
REM-LLO	483
REMOTE	483
RFSweep	483
S&H	483
Table	483
UCorr	484
Status registers	270
CONDition	272
ENABle	272
EVENT	272
model	271
NTRansition	272
parts	271
PTRansition	272

- Status reporting system 269
 - Application 275
 - Common commands 280
 - STB 270
 - Step
 - Level Sweep 187
 - Step lin
 - LF sweep 225
 - RF sweep 180
 - Step log
 - LF sweep 225
 - RF sweep 180
 - Step width
 - Frequency 140
 - Level Sweep 187
 - LF sweep 225
 - RF sweep 180
 - Stereo modulation 211
 - Stop bits
 - RS232 interface 110
 - Stop Freq - LF Sweep 224
 - Stop Freq - RF Sweep 179
 - Stop Level 186
 - Storing 480
 - Subnet mask
 - Network settings 106
 - Suffixes 260
 - Support 488
 - Sweep
 - Retrace (LF frequency) 225
 - Retrace (RF frequency) 180
 - Retrace (RF level) 186
 - RF frequency sweep 176
 - Start Level 185
 - Stop Level 186
 - Trigger 178, 185
 - Sweep - Center frequency 179
 - Sweep - LF start frequency 224
 - Sweep - LF stop frequency 224
 - Sweep - Trigger 223
 - Sweep output voltage 181, 182
 - Sweep shape
 - RF Level Sweep 186
 - Sweep shape - LF Frequency Sweep 224
 - Sweep shape - RF Sweep 179
 - Sweep spacing
 - Level Sweep 187
 - Sweep spacing - RF Sweep 179
 - Synchronization bandwidth
 - reference oscillator 144
 - Syntax elements
 - SCPI 264
 - System
 - Identification 111
 - IDN string 111
 - Language 111
 - Network Mac address 107
 - Set IDN and OPT to default 111
 - System directory 302
- T**
- Target level
 - NRP-Z level control 157
 - NRP-Z power control 385
 - Test
 - Check front panel 102
 - Time
 - Setup 103
 - UTC 103
 - Timezone
 - Setup 104
 - UTC 104
 - Toggle Summary Screen 108
 - Trigger
 - Event (remote) 283
 - Trigger Input Slope 182, 187, 193, 226
 - Trigger mode
 - Pulse modulation 228
 - Trigger source
 - LF sweep 221
 - RF frequency sweep 176
 - Trigger Source
 - Level Sweep 183
 - List Mode 189
 - Triggering sweep manually 185
 - Troubleshooting 481
 - TS-USB1
 - USB adapter 109
 - Type
 - Power sensors 169
 - Type - Power Sensors 324
- U**
- UCorr 484
 - Ultr@VNC 40
 - Uninterrupted level setting 149
 - Unit
 - Power sensors 169
 - Units 262
 - Input 18
 - UNIX controller 40
 - UP 262
 - Update sensor 97
 - USB
 - Adapter TS-USB1 109
 - Interfaces 240
 - Remote control interface 235
 - USB Storage - Setup 118
 - Use default aperture time
 - Power sensors 173
 - Use LF connector to output sweep voltage 181
 - Use peak power
 - NRP-Z level control 157
 - NRP-Z power control 384
 - Use SParameter
 - NRP-Z power control 157, 173
 - NRP-Z power viewer 157, 173
 - Use SParameters - Power Sensors 317
 - User Correction 158
 - User Correction Data 159
 - User interface
 - Lock (security) 118
 - User Name - Setup 115
 - User password
 - Security 115
 - Setup 115
 - User variation
 - RF frequency settings 140
 - Variation active 140
 - Variation step 140

V

Value - User Correction	159
Variation Active	140
Variation step	140
Variation Step	140, 150
Video-Sync signal state	
Pulse generator	227
VISA	235, 238
Libraries	236
Resource string	236, 238
VISA resource string	
Ethernet	110
GPIB	110
HISLIP	110
Serial	110
Socket	110
USB	110
VNC	
LAN Services	117
VNC connection	40
Voltage ramp	
RF sweep	181
VXI protocol	239

W

Wait	
Remote	284
Wait Time	108
Warnings	69, 484
Web Control	
LXI	50
White papers	14
White space	264
Width	
Double pulse	228
Pulse generator	228
Workgroup	
Network settings	105
Write nonvolatile memory	
Setup	118

Z

Zero	
Power sensors	156, 170
Zero - Power Sensors	324
Zeroconf	
IP address	487
Zoom	
Pulse Train	231
Zoom Position	
Pulse Train	231