

# SAILOR SYSTEM 5000 MF/HF 150/250/500W





# Introduction

Congratulations on your new SAILOR CU5100 MF/HF maritime radio telephone with built-in DSC (Digital Selective Calling) system, fulfilling the highest international standards for marine MF/HF communication and safety procedures. The transceiver is born with a 2187,5kHz DSC watch receiver forming an ideal system for MF GMDSS installations. The transceiver can easily be upgraded for 6 channel scanning DSC watch receiver and Telex operation to comply with MF/HF requirements in sea area A3. If connected to a GPS or other maritime navigation system it can automatically include the true UTC time and your position in its DSC distress messages.

This SAILOR marine equipment is a part of the modular system 5000 which also includes a HF single sideband radiotelephone. SAILOR marine equipment is specially designed for the extremely rugged conditions on board a ship, based on more than 50 years' experience with all kinds of boats, from small pleasure crafts, over fishing boats working under all climatic conditions, to the biggest ships.

SAILOR<sup>®</sup> is one of the worlds leading manufacturers of maritime radiocommunication equipment - a position which has been maintained by means of constant and extensive product development. We have a worldwide network of dealers with general agencies in more than 80 countries. All our dealers are specially trained to service all your SAILOR<sup>®</sup> products.

## About this manual

This manual is for the daily user of the system. Additionally, it includes a section on the installation procedures, and - on page iii - standard distress procedures. **We highly recommend you to read the manual before you start using the equipment.**

Notice: There may be some minor differences in the graphic layout of the manual compared to the physical device.

### Disclaimer

Any responsibility or liability for loss or damage in connection with the use of this product and the accompanying documentation is disclaimed by Thrane & Thrane. The information in this manual is provided for information purposes only, is subject to change without notice, may contain errors or inaccuracies, and represents no commitment whatsoever by Thrane & Thrane. This agreement is governed by the laws of Denmark.

Manuals issued by Thrane & Thrane are periodically revised and updated. Anyone relying on this information should satisfy himself/herself as to the most current version. Providers with access to Thrane & Thrane's Extranet may obtain current copies of manuals at: <http://extranet.thrane.com>.

Thrane & Thrane is not responsible for the content or accuracy of any translations or reproductions, in whole or in part, of this manual from any other source.

# Training Information (valid for TU5160)

The System 5000 MF/HF is designed for “occupational use only” and is also classified as such.

It must only be used in the course of employment by individuals aware of both the hazards as well as the way to minimize those hazards.

The radio is thus NOT intended for use in an uncontrolled environment by general public. The System 5000 MF/HF has been tested and complies with the FCC RF exposure limits for “Occupational Use Only”. The radio also complies with the following guidelines and standards regarding RF energy and electromagnetic energy levels including the recommended levels for human exposure:

- FCC OET Bulletin 65 Supplement C, evaluating compliance with FCC guidelines for human exposure to radio frequency electromagnetic fields
- American National Standards Institute (C95.1) IEEE standard for safety levels with respect to human exposure to radio frequency electromagnetic fields, 3 kHz to 300 GHz
- American National Standards Institute (C95.3) IEEE recommended practice for the measurement of potentially hazardous electromagnetic fields – RF and microwaves

Below the RF exposure hazards and instructions in safe operation of the radio within the FCC RF exposure limits established for it are described.

## Warning:

Your radio set generates electromagnetic RF (radio frequency) energy when it is transmitting. To ensure that you and those around you are not exposed to excessive amounts of that energy (beyond FCC allowable limits for occupational use) and thus to avoid health hazards from excessive exposure to RF energy, FCC OET bulletin 65 establishes an Maximum Permissible Exposure (MPE) radius of 6" (1.8m) for the maximum power of your radio (150W selected) with a whip antenna having a maximum gain of 3.0dBi. This means all persons must be at least 6" (1.8m) away from the antenna when the radio is transmitting.

## Installation:

1. A whip antenna with a maximum power gain of 3 dBi must be mounted at least 12.6" (3.9m) above the highest deck where people may be staying during radio transmissions. The distance is to be measured vertically from the lowest point of the antenna. This provides the minimum separation distance which is in compliance with RF exposure requirements and is based on the MPE radius of 6" (1.8m) plus the 6.6" (2.0m) height of an adult.
2. On vessels that cannot fulfil requirements in item 1, the antenna must be mounted so that its lowest point is at least 6" (1.8m) vertically above the heads of people on deck and all persons must be outside the 6" (1.8m) MPE radius during radio transmission.
  - Always mount the antenna at least 6" (1.8m) from possible human access
  - Never touch the antenna when transmitting
  - Use only authorized T&T accessories
3. If antenna has to be placed in public areas or near people with no awareness of the radio transmission, the antenna must be placed at a distance not less than 12" (3.6m) from possible human access.

Failure to observe any of these warnings may cause you or other people to exceed FCC RF exposure limits or create other dangerous conditions.

## Abbreviations used in this manual

ADDR	Address
AGC	Automatic Gain Control
AM	Amplitude Modulation
ARQ	Automatic Repetition reQuest
CLRF	Clarify
CU	Control Unit
DIRTLX	Direct Telex
DSC	Digital Selective Calling
ETSI	European Telecommunications Standards Institute
FEC	Forward Error Correction
GA	Go Ahead
GMDSS	Global Maritime Distress and Safety System
GPS	Global Positioning System
HF	High Frequency
H3E	Single sideband - full carrier
IMO	International Maritime Organisation
IRS	Information Receiving Station
ISS	Information Sending Station
ITU	International Telecommunication Union
J3E	Single sideband - no carrier
MF	Medium Frequency
MMSI	Maritime Mobile Ship Identification
MOM	Just a moment please
MSG	Message
NBDP	Narrow Band Direct Printing
PTT	Push-To-Talk
RF-G	Receiver Frequency Gain
Rx	Receive
SSB	Single Side Band
TEL	Telephony
Tx	Transmit
UTC	Co-ordinated Universal Time
VHF	Very High Frequency
WRU	Who Are You

# Safety instruction

## DANGER



**Never touch the Antenna Tuning Unit or feeder wire when the radiotelephone is transmitting.**

High voltage which will cause death or serious injury is present at the locations shown in the illustration below when the radiotelephone is transmitting.

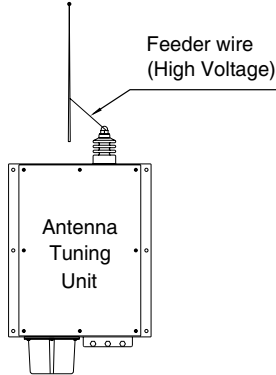

99-126550

## WARNING



**ELECTRICAL SHOCK HAZARD**

**Do not open the equipment.**

**Only qualified personnel should work inside the equipment.**

# Quick DSC distress call (only for emergency use)



1. If necessary, switch on by pressing the ON/OFF button



2. Lift up the lid covering the orange  key and press for 3 seconds.
3. The distress will be accompanied by a sound.  
Distress message is sent at the continuous tone.
4. Wait for distress acknowledgement and start mayday procedure. Unless stopped manually, by pressing the CANCEL softkey or switching the unit off, the distress call is automatically repeated every 3½-4½ minutes until distress acknowledgement is received.

If an alarm panel is connected the MF/HF DISTRESS button on this unit will have the same functionality as the distress button described above. All further handling should continue in front of your main MF/HF DSC.

## Mayday procedure

When DSC distress acknowledgement is received after you have pressed DISTRESS, or if you otherwise need to commence distress traffic via radiotelephony on the distress traffic frequency, follow this procedure:

- the distress signal MAYDAY, spoken three times;
- the words THIS IS;
- the NAME of the vessel in distress, spoken three times;
- the CALL SIGN or other identification;
- the MMSI if needed;
- the POSITION given as the LATITUDE and LONGITUDE or with respect to known geographical location,
- the NATURE of the distress;
- the kind of ASSISTANCE required; and
- any other useful INFORMATION

Upon reception of a DSC distress alert from another ship in distress, you should acknowledge the receipt by radiotelephony on the distress traffic frequency, by doing the following:

- the distress signal MAYDAY;
- the words THIS IS;
- the NAME of the vessel in distress, spoken three times;
- the NAME or other identification of own ship, spoken three times;
- "RECEIVED MAYDAY".

### Transmission of DSC distress alert on MF/HF (2, 4, 6, 8, 12, 16 MHz)

2187.5 kHz, 4207.5 kHz, 6312.0 kHz, 8414.5 kHz, 12577.0 kHz, 16804.5 kHz

# The MF/HF at a glance (CU5100)

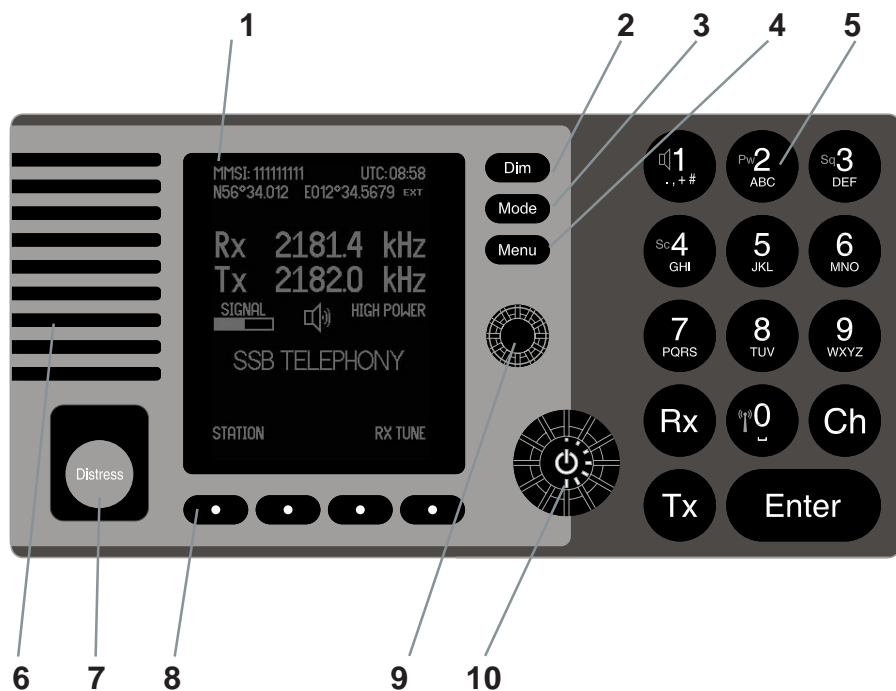

1. Display.
2. Dimming button.
3. Mode button used to toggle between modes.
4. Menu button.  
Access to the menu system.
5. Keyboard.
6. Loudspeaker.
7. DISTRESS button.  
Protected by shield. To use, lift the shield and press for 3 seconds.
8. Soft keys.  
The function of each key is described in its respective field in the display above each key.
9. Adjust/Tune.  
Multi purpose rotary knob.  
Controls backlight, frequency and RX tune range.
10. ON/OFF / VOLUME control



# Contents

<b>Introduction</b> .....	<b>iii</b>
About this manual .....	iii
Training Information .....	iv
Abbreviations used in this manual .....	v
Safety instruction .....	vi
<b>Quick DSC distress call</b> .....	<b>vii</b>
<b>Mayday procedure</b> .....	<b>vii</b>
<b>The MF/HF at a glance (CU5100)</b> .....	<b>viii</b>
<b>1 MF/HF Fundamental info</b> .....	<b>3</b>
<b>2 Basic functions</b> .....	<b>4</b>
2.1 Powering MF/HF .....	4
2.2 Speaker volume .....	4
2.3 Switches loudspeaker On/Off .....	4
2.4 Change output power .....	4
2.5 Squelch On/Off .....	4
2.6 Dimming .....	5
2.7 Change mode .....	5
2.8 How to operate the menu .....	5
2.9 How to make a call to a coast station .....	6
2.10 Telephony display functions .....	6
<b>3 Voice call operation</b> .....	<b>7</b>
3.1 Operating MF/HF radio communication .....	7
3.2 Listening for calls from a coast station .....	7
3.3 Enter Rx/Tx frequency .....	8
3.4 Channel entry .....	9
3.5 Select a channel from the station table .....	11
3.6 Re-tune the Antenna tuner .....	12
<b>4 DSC operation</b> .....	<b>13</b>
4.1 DSC main .....	13
4.2 DSC setup .....	14
4.3 Receiving a Distress Call .....	16
4.4 Receiving an Individual call .....	17
4.5 Sending a test call .....	19
4.6 Calling a coast station .....	21
4.7 Calling a ship .....	23
4.8 Sending an area call .....	25
4.9 Repeat a call .....	27
4.10 Composed DSC calls .....	28
4.11 DSC call menu .....	30
4.12 Geographic Area Computation .....	30
<b>5 User setup</b> .....	<b>31</b>

<b>6</b>	<b>Telex operation</b> .....	<b>32</b>
6.1	Telex setup .....	32
6.2	Simple telex operation .....	33
6.3	Telex via data terminal .....	39
<b>7</b>	<b>Data call</b> .....	<b>39</b>
<b>8</b>	<b>Scanning</b> .....	<b>40</b>
<b>9</b>	<b>Watch keeping receiver</b> .....	<b>41</b>
9.1	Watch receiver setup .....	41
<b>10</b>	<b>Menu tree</b> .....	<b>42</b>
<b>11</b>	<b>Installation</b> .....	<b>44</b>
11.1	Compass safe distance .....	44

# 1 MF/HF Fundamental info

## Propagation of MF and HF Radio Waves.

MF/HF radiocommunications provide a medium and long range service. The 1.6-4 MHz marine band is intended primarily for coastal operation beyond normal VHF communication range. A reliable range of more than 150 nautical miles can be expected in most areas in the daytime, more in the nighttime. Propagation of the radio waves in this band is mainly by ground waves i.e. the waves from the transmitter aerial follow the earth's curvature to the receiver aerial. The high frequency range 4 - 30 MHz can provide communication for hundreds or even thousands of nautical miles. The long range is achieved by sky waves reflected from the ionosphere. Propagation of the radio waves depends on a number of factors such as frequency, time of day, time of year, and solar activity. The channels allocated to the maritime mobile service in the HF range are divided into a number of bands: 4, 6, 8, 12, 16, 18, 22, 25 MHz to allow a suitable frequency band to be selected for communication dependent on distance and time of day.

## Radiotelephony

The mode of emission used for telephony transmissions in the marine bands is SSB (single-sideband, J3E). On the international distress frequency 2182 kHz compatible AM (amplitude modulation, H3E) may be used in addition for communication with non-GMDSS ships. AM mode is used also when receiving broadcasting. The frequencies for radiotelephone distress and safety traffic in the HF bands are 4125 kHz, 6215 kHz, 8291 kHz, 12290 kHz, and 16420 kHz. Working frequencies for public correspondence with coast stations are arranged in pairs for duplex/semi-duplex operation. For the HF bands these channels are allocated numbers by ITU on an international basis. In addition a number of simplex frequencies are available in each band for ship-to-ship communication.

## Radiotelex

Marine telex is also referred to as (NBDP) 'Narrow Band Direct Printing'. Due to the narrow bandwidth of the transmissions, a longer range may be expected compared to radiotelephony. The frequencies for radiotelex distress and safety traffic are 2174.5 kHz, 4177.5 kHz, 6268 kHz, 8376.5 kHz, 12520 kHz, and 16695 kHz. Working frequencies for public correspondence with coast stations are arranged in pairs. For the HF bands these channels are allocated numbers by ITU on an international basis. In addition a number of simplex frequencies are available in each band for ship-to-ship communication.

## DSC

DSC (Digital Selective Calling) is an automatic calling system which allows a specific station to be contacted and made aware that a station wishes to communicate with it. In addition to calls to specific stations the system can also be used to call groups of ships and this is of significance for its use for DSC distress alerting. DSC is an alerting signal only and the communication which follows the call is made on an appropriate frequency band using radiotelephony or radiotelex. The frequencies for DSC distress and safety calling are 2187.5 kHz, 4207.5 kHz, 6312 kHz, 8414.5 kHz, 12577 kHz, and 16804.5 kHz. Calling frequencies for public correspondence with coast stations are arranged in pairs, both international and national frequencies are assigned. In addition the frequency 2177 kHz may be used for ship-to-ship calling.

## 2 Basic functions

### 2.1 Powering MF/HF



The MF/HF is turned on by a single press on the ON/OFF/Volume button.

The MF/HF is turned off by pressing the ON/OFF/Volume button for 4 seconds.

Always indicated by a count down window in the information display, except if the radio is powered down in distress mode.

Any connected devices (Alarm Panel, Handset, Control Units) will be operational only if the MF/HF is powered.

Start-up display is last used mode.

Note: The equipment should always be switched on while at sea in order to maintain continuous DSC watch.

### 2.2 Speaker volume



The volume in the loudspeaker (internal and external) is adjusted by turning the VOLUME control. The volume level is visualized in the display. The volume can be adjusted to a mute mode by turning the volume control left.

### 2.3 Switches loudspeaker On/Off



Switches loudspeaker on/off

The loudspeaker symbol in the display will show if the loudspeaker is on or off.



### 2.4 Change output power



Changes between 'HIGH POWER' and 'LOW POWER'.

DSC and Telex calls are automatically sent in 'HIGH POWER'.

### 2.5 Squelch On/Off



Changes between squelch on and off, indicated in the telephony display by 'SQUELCH' and squelch off (no indication). When squelch is on the receiver is muted in speech pauses.

Squelch is automatically set to off by a change of RX frequency except during scanning.

Squelch is automatically set to on when scanning is activated and to off when scanning is deactivated.

May be switched on and off during scanning.

Always off in AM and SSB Remote mode.

## 2.6 Dimming

**Dim**

To adjust backlight intensity the dim button is pressed.

## 2.7 Change mode

**Mode**

With the mode button different operation modes can be selected.

Toggle the button to choose between SSB TELEPHONY, AM BROADCAST, DSC, TELEX(Optional) and SSB REMOTE.

**Note:** When in AM BROADCAST mode the transceiver cannot be keyed.

## 2.8 How to operate the menu

**Menu**

Press the Menu button

### Main menu:

The 4 soft keys at the bottom of the display will have different functionality depending of the menu items.

Navigate the menu by using up- and down key.

Press OK when the select bar is at the preferred menu item.

Press CANCEL if you want to leave the main menu.

### Quick select:

In the main menu it is also possible to select a menu item by pressing the corresponding number key on the keypad.

### In a sub menu

Press any soft key to choose operation.

Press cancel to return to previous menu.

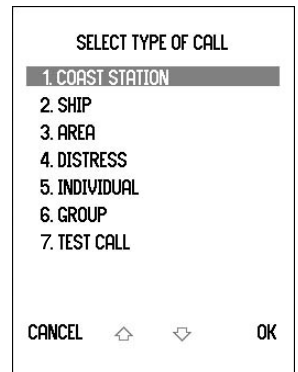
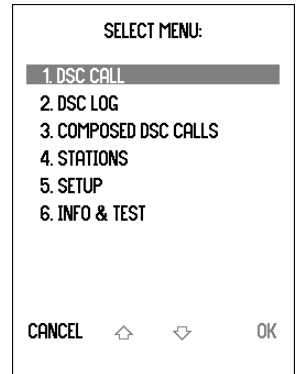

## 2.9 How to make a call to a coast station

Wait until transmission of the traffic list has finished and the channel is free. Call the coast station on the working frequency on which the traffic list was received or as instructed by the coast station.

- Hook off the handset.
- Press the PTT key on the handset when speaking.  
Say:
  - <Called station's name (3 times)>
  - 'This is' <Your ship's name (3 times)>
  - 'Over'
- Release the PTT key to listen.
- When answered:  
Follow the instructions from the coast station. The coast station may ask for further identification, information on position and next port of call, and may suggest another working channel for the traffic to follow. If the coast station is not ready to receive traffic immediately it may ask you to wait for a specific number of minutes.

**PTT** only when you are talking. If on a simplex channel (in other words, a channel that can carry only one transmission at a time), always say "Over" just before releasing.

## 2.10 Telephony display functions

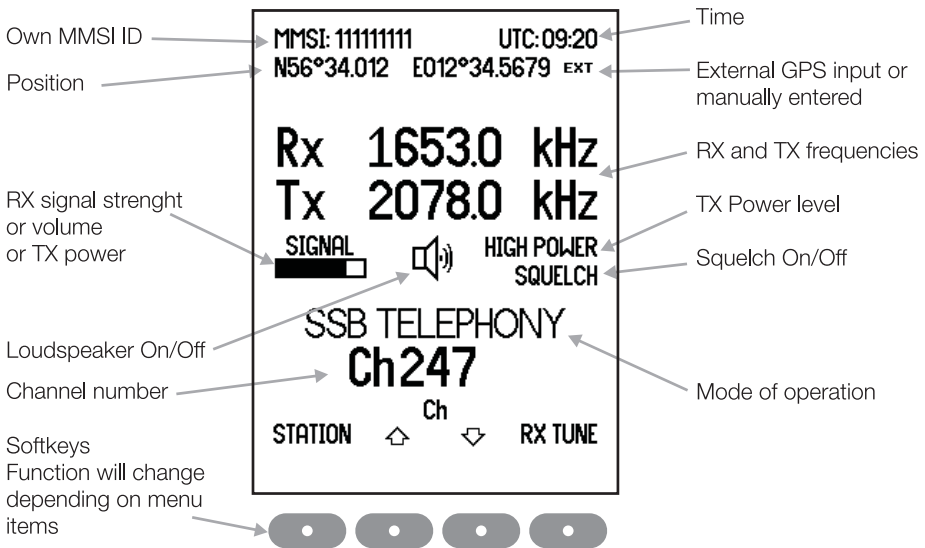

# 3 Voice call operation

## 3.1 Operating MF/HF radio communication

The MF/HF is operated by means of a handset.

To bring the MF/HF in transmission mode the handset must be hooked off and the PTT button on the handset has to be pressed. Transmission is indicated by the lighted TX indicator.

Receive mode is always reached by releasing the PTT button.

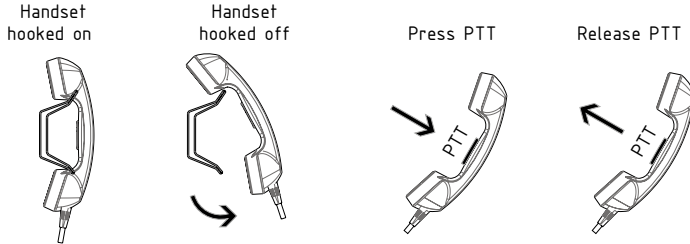

Transmit and receive is performed on the frequencies or channels shown in the telephone display.

## 3.2 Listening for calls from a coast station

Coast stations transmit traffic lists consisting of call signs/names of the ships for which they have traffic.

The traffic lists are sent at specified times and at intervals of typically two hours. They are broadcasted on the normal working frequencies from the coast station. Ships should, as far as possible, listen to the traffic lists transmitted by relevant coast stations. On hearing their call sign they should establish communication as soon as they can do so.

1. Select the appropriate station.
2. Select the channel on which traffic lists are transmitted.
3. Switch loudspeaker on and adjust volume to an appropriate level.

On HF verbal traffic lists are transmitted in more frequency bands simultaneously. Search for the channel with the best propagation conditions.

### 3.3 Enter Rx/Tx frequency

**Rx**

Press RX to enter a new Rx frequency.

Enter the new frequency via the keyboard.

**Enter**

Complete by pressing Enter. Pressing the ENTER softkey is equal to pressing OK

**Tx**

Press TX to enter a new Tx frequency.

Enter the new frequency and complete by pressing Enter.

Pressing the Rx softkey copies Rx frequency to the Tx.

Pressing the Tx softkey copies Tx frequency to the Rx.

Pressing the ↵ softkey deletes last entry.

Pressing the CANCEL softkey resets the display.

#### RX tune

To fine tune the Rx value turn the Adjust/Tune knob or press the RX TUNE soft key.

Pressing RANGE softkey more times will toggle the detail of tuning (10Hz, 100Hz or 1kHz)

Turn the Adjust/Tune knob to fine tune the value or use the ⬆ and ⬇ softkeys.

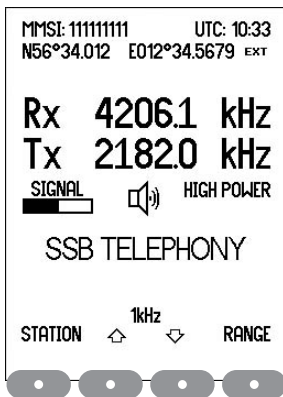

Use softkey ⬆ and ⬇ to fine tune the value

Last digit always interpreted as "10Hz "- digit.



## 3.4 Channel entry

### 3.4.1 Select a channel

The MF/HF control unit has all ITU channels preprogrammed in a channel table. These channels starts at Ch 241 and ends at Ch 2517.

Channel 1 to 199 are reserved as user channels.



Press Ch and key in an existing channel number.



Complete by pressing Enter or by pressing the ENTER softkey. The channel number is displayed in the display.



Use softkey and to scroll through the channel numbers.

### 3.4.2 Store a channel

Select the desired RX frequency, TX frequency and mode setting.



Press Ch and key in a channel number between 1 and 199.



↩ softkey, deletes the previous entry  
 STORE softkey, stores the channel  
 CANCEL softkey, selects the previous display

If the channel number is free, press the STORE softkey to store the channel.

### 3.4.3 Delete a channel

To delete a channel first access the channel by pressing Ch and key in the channel number between 1 and 199, complete by pressing Enter or by pressing the ENTER softkey. The DELETE softkey is available.



↩ softkey, deletes the previous entry  
 Press DELETE softkey to delete the channel.  
 CANCEL softkey, selects the previous display



Confirm by pressing OK.  
 CANCEL softkey, selects the previous display

### 3.4.4 Replace a channel

Select the desired RX frequency, TX frequency and mode setting.



Press Ch and key in a channel number between 1 and 199.

Press the REPLACE softkey to store the channel.

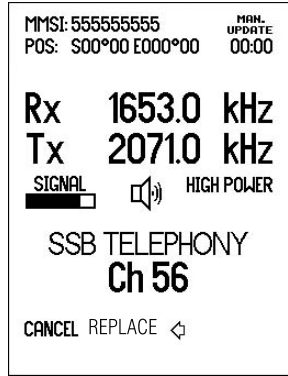

softkey, deletes the previous entry  
 REPLACE softkey, to convert to the new RX and TX frequencies.  
 CANCEL softkey, selects the previous display

### 3.5 Select a channel from the station table

Press the STATION softkey in the Telephony display.

Station names are shown

Channels allocated the selected station is shown

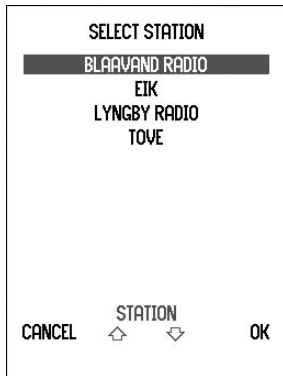

Selects the station  
 Steps to the previous/next station in alphabetic order  
 CANCEL softkey, selects the previous display

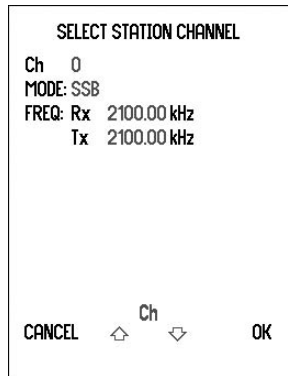

Selects the station and returns to telephony display  
 Steps to the previous/next station  
 CANCEL softkey, selects the previous display

The radio is ready for use on the selected channel.

## 3.6 Re-tune the Antenna tuner

Press the button '0' for re-tuning the antenna tuner.



Also TX tuning is done automatically the first time the transmitter is keyed on a new frequency and before any DSC transmission.

# 4 DSC operation

## 4.1 DSC main

**Menu**

Press the Menu button

Using the Down key and press OK when the select bar is at the preferred menu, or use quick select.

DSC CALL - Alternative press Mode button until DSC mode, and press DSC CALL softkey.

### DSC CALL

Select 1. DSC CALL. Opens DSC transmitter menu. From here it is possible to make routine calls: COAST STATION, SHIP and special calls: AREA, DISTRESS, INDIVIDUAL, GROUP and TEST CALL.

### DSC LOG

Select 2. DSC LOG. Opens a menu to the DSC LOG where DSC calls are stored. In this menu, received distress calls, other received calls and transmitted calls, sorted by time can be read separately. Received calls are deleted after 48 hours.

### COMPOSED DSC CALLS

Select 3. COMPOSED DSC CALLS. Opens the COMPOSED DSC CALLS menu. In the menu complete DSC calls can be composed and stored for later used, or already stored DSC calls can be selected.

## 4.2 DSC setup

Menu

Press the Menu button

Select 5. SETUP.

Select 1. DSC SETUP.

DSC SETUP

DISTRESS FREQUENCY: 2187.5

AUTO ACKNOWLEDGEMENT: OFF

AUTO POSITION TRANSMIT: OFF

AUTO CHANNEL SWITCH: ON

TELECOMMAND MEDICAL: ON

TELEC. SHIP AND AIRCRAFT: ON

LAT: N11°40 EXT.

LON: E123°45 EXT.

POSITION TIME: 10:32 EXT.

DATE: 01 JAN 2007

TIME: 01:00

CANCEL NEXT ▷ CHANGE SAVE

Detail



Use CHANGE softkey - to change setup

Steps to the next

Use CANCEL softkey - to return to previous display

Change LAT/LON - to manually enter position if no GPS position

Change TIME - to set real time clock if no GPS time and date

TIME and POSITION TIME disappear when information is updated via the NMEA interface. If not updated via the NMEA interface DATE and TIME must be set manually each time the equipment is switched on.

An alarm is given if position data is not received via the NMEA interface for 30 seconds. In this case position information must be entered manually. In case of manual input an alarm is given when the position information is more than 4 hours old. Any position information is deleted if not updated for 23½ hours.

### Set answer back mode

AUTO ACKNOWLEDGEMENT = ON:

Transmission of acknowledgement is initiated automatically when a direct call, polling or position request call is received.

AUTO ACKNOWLEDGEMENT = OFF:

Manuel acknowledgement only. Direct calls initiated by the ship can be carried through; direct calls from coast stations cannot (factory default).

Note: The purpose is to enable the user to prevent automatic transmissions, e.g. when the ship is in port.

### Set auto position transmit

AUTO POSITION RESPONSE = ON:

Position information is included in direct calls and position request acknowledgements

AUTO POSITION RESPONSE = OFF:

Position information is excluded in direct calls and position request acknowledgements

### Set auto channel switch

AUTO CHANNEL SWITCH = ON:

??

AUTO CHANNEL SWITCH = OFF:

??

### Set telecommand

TELECOMMAND AND MEDICAL = ON:

Is only available by default after changing relevant parameters in the setup menu

TELECOMMAND AND MEDICAL = OFF:

Is only available by default after changing relevant parameters in the setup menu

TELEC. SHIP AND AIRCRAFT = ON:

Is only available by default after changing relevant parameters in the setup menu

TELEC. SHIP AND AIRCRAFT = OFF:

Is only available by default after changing relevant parameters in the setup menu

## 4.3 Receiving a Distress Call

The DSC Watch Receiver keeps continuous watch on the distress and safety frequency 2187.5 kHz. Reception of a distress or urgency call is indicated by a specific sound signal which continues until a key is pressed. Additional DSC channels can be used if 6-channel scan has been enabled, see chapter "Watch keeping receiver".

Detail

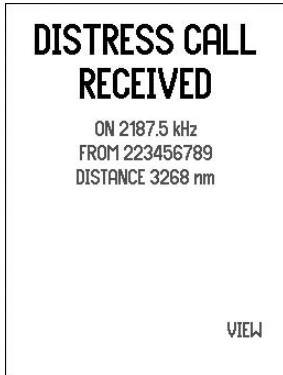

Press to read the call

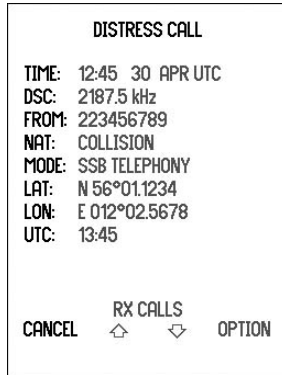

Select distress call options

Selects older/newer call

Returns to previous telephony display

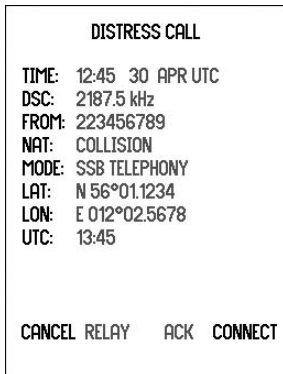

Press to connect



Returns to previous telephony display

Ships receiving a distress alert from another ship should prepare for receiving the subsequent distress communication on the telephony distress frequency in the same band in which the DSC call was received.

Wait for a short interval in order to give a coast station time to acknowledge the DSC distress alert first. Then, if within range and able to assist, acknowledge the receipt of the distress alert by radiotelephony:

Press the handset key and say:

- the distress signal MAYDAY;
- the words THIS IS;
- the NAME of the vessel in distress, spoken three times;
- the NAME or other identification of own ship, spoken three times;
- "RECEIVED MAYDAY".



## 4.4 Receiving an Individual call

When the transceiver is not used for traffic, scanning should be activated to keep watch on one or more DSC frequencies used for public correspondence and general ship-to-ship communication.

Reception of an individual routine call addressed to the ship is indicated by a sound signal which continues until the call is acted upon. The call alarm sound level setting can be changed, see the Menu tree.

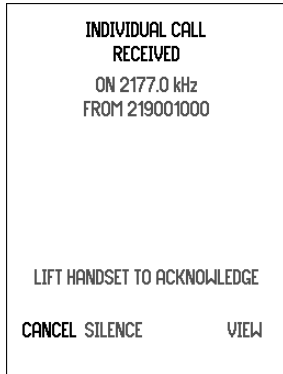

Press ACK or lift handset  
Stops alarm sound



Displays the contents of the call  
Stops transmission and returns to the previous display

The call should be answered by sending a DSC Acknowledgement within 4½ minutes. **LIFT HANDSET TO ACKNOWLEDGE** and **ACK** is shown if *SSB telephony* and legal frequencies are indicated in the call. Lifting the handset or pressing the softkey in this case will initiate transmission of an acknowledgement containing the mode and frequencies from the received call.

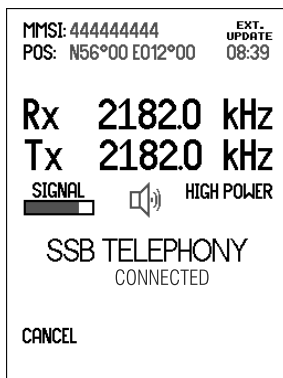

Returns to previous telephony display

Transmission of the DSC acknowledgement takes approx. 8 seconds. Then the equipment is automatically set to the mode and working frequencies from the acknowledgement, and voice communication can start.

When handset is placed on hook the equipment returns to previous telephony setting.

**Direct Dial Calls:**

Some coast stations provide automatic connection from the public switched telephone network allowing a telephone subscriber to call the ship directly without operator intervention at the coast station.

Note: Auto Acknowledgement must be On to allow automatic connection, see DSC Status Display.

An acknowledgement is initiated immediately when a Direct Dial call is received. The handset should be lifted off hook within 1 minute which will initiate a DSC call on the working frequency. This call is used by the coast station for channel quality evaluation. When acknowledgement is received telephone conversation can start.

When the handset is placed on hook after a Direct Dial call a DSC call indicating 'End of call' is sent to terminate the connection. The coast station may respond with a DSC Call indicating the chargeable duration of the connection.

## 4.5 Sending a test call

This call type is intended for test of the DSC system on distress and safety frequencies.

**Menu**

Press the Menu button.

SELECT MENU:

1. DSC CALL
2. DSC LOG
3. COMPOSED DSC CALLS
4. STATIONS
5. SETUP
6. INFO & TEST

CANCEL    ⬆    ⬇    OK



Select OK

Navigate the menu by using Up- and Down key

SELECT TYPE OF CALL

1. COAST STATION
2. SHIP
3. AREA
4. DISTRESS
5. INDIVIDUAL
6. GROUP
7. TEST CALL

CANCEL    ⬆    ⬇    OK



Select TEST CALL type

SELECT SHORE CALL

1. SHIP TEST CALL
2. COAST STATION TEST CALL

CANCEL    ⬆    ⬇    OK



Select OK

ENTER COAST STATION MMSI

TYPE: TEST CALL

TO: 002191000\_

CANCEL    RECALL    ⬅    OK

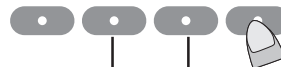

Insert the number in the call

Backspace, deletes last digit

Selects a submenu where a pre-programmed coast station can be selected

Key in the nine digit MMSI number of the nearest coast station which can accept and reply to DSC test calls.

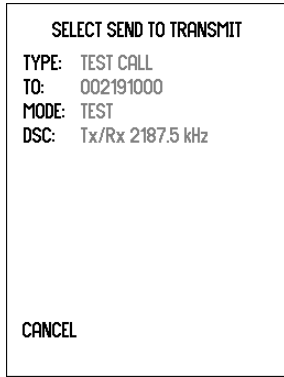
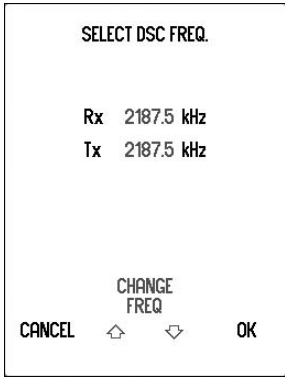

Select the DSC frequencies

Steps between DSC distress frequencies



Start transmission of the call

Transmission of a DSC call on MF/HF takes approx. 8 seconds. The coast station should answer the call by sending a DSC Acknowledgement within 4 1/2 minutes. No further communication is intended to take place.



Displays the contents of the acknowledgement

## 4.6 Calling a coast station

**Menu**

Press the Menu button and select 1. DSC CALL

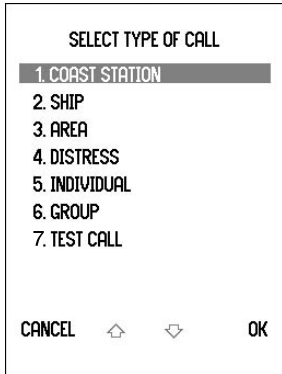

Select COAST STATION call type

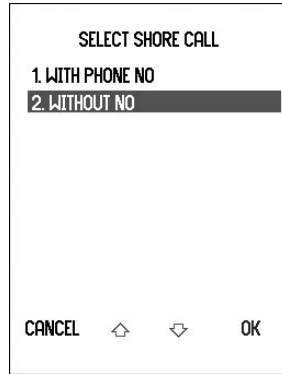

Select individual routine call type

Some coast stations provide automatic connection with the public switched telephone network. To use this facility select PHONE NO and key in the telephone number. Otherwise: Key in the nine digit MMSI number of the wanted coast station.

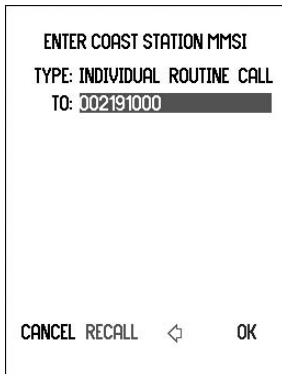

Insert the number in the call

Backspace, deletes last figure

Selects a submenu where a pre-programmed coast station can be selected

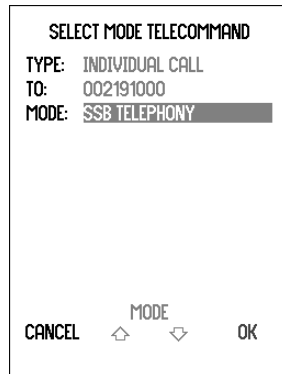

Select mode

Steps between modes

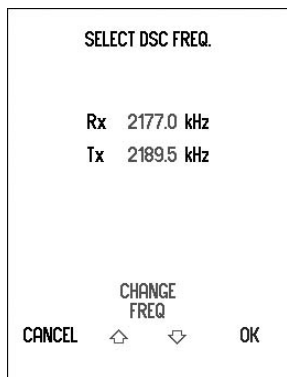

Select the DSC frequency

Steps between DSC frequencies

If the MMSI number is found in the station list, the frequencies are selected from the DSC frequencies of the station if any; otherwise from the list of non distress DSC frequencies. If DSC frequencies were selected from the Telephony display prior to the call these are default. Distress frequencies cannot be selected in any way.

Transmission of a DSC call on MF/HF takes approx. 8 seconds. The Coast station if able to comply will answer the call within 4½ minutes by sending a DSC Acknowledgement containing information on working frequencies for the subsequent traffic. When acknowledgement is received lift the handset to set the radio to the working frequencies.

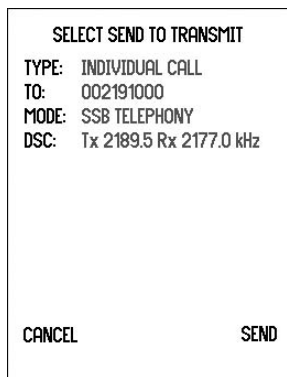

Start transmission of the call



Displays the contents of the acknowledgement  
Sets mode and frequency as indicated in the acknowledgement

If no acknowledgement is received within 5 minutes, the equipment returns to the previous telephony display and starts scanning if selected.

## Direct Dial Calls:

If a phone number was included in the call then immediately after reception of the acknowledgement the DSC call is repeated on the working frequency. This call may be used by the coast station for channel quality evaluation. If the channel quality evaluation indicates that communication will be satisfactory, the coast station sends a DSC acknowledgement and starts dialing the subscriber number. Dialing tones may be heard in the speaker or handset.

When the handset is placed on hook after a Direct Dial call a DSC call indicating 'End of call' is sent to terminate the connection. The coast station may respond with a DSC call indicating the chargeable duration of the connection.

## 4.7 Calling a ship

### Menu

Press the Menu button and  
select 1. DSC CALL.  
select 2. SHIP.

Key in the nine digit MMSI number of the wanted ship.

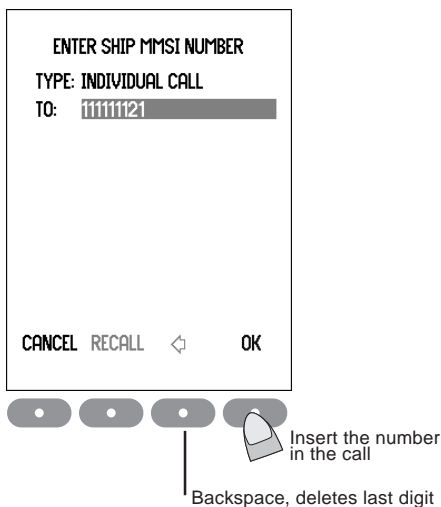

A working channel shall be proposed when calling another ship.

**Detail**

**ENTER WORK FREQ**

TYPE: INDIVIDUAL CALL  
 TO: 11111121  
 MODE: SSB TELEPHONY  
 WORK: Rx 1223.3 Tx 8707.0 kHz

CANCEL CHANGE OK

**SELECT DSC FREQ.**

Rx: 2177.0 kHz  
 Tx: 2177.0 kHz

CHANGE FREQ

CANCEL OK



Insert the working frequencies in the call  
 Selects telephony display for change of working frequencies



Select the DSC frequency  
 Steps between DSC frequencies

Normally 2177 kHz is used for intership DSC calls. In addition user programmed DSC frequencies may be selected. If DSC frequencies were selected from the Telephony display prior to the call these are default. Distress frequencies cannot be selected in any way.

Transmission of a DSC call on MF/HF takes approx. 8 seconds. The called ship is supposed to answer the call within 4½ minutes by sending a DSC Acknowledgement containing information on working frequencies for the subsequent traffic. When acknowledgement is received lift the handset to set the radio to the working frequencies.

**SELECT SEND TO TRANSMIT**

TYPE: INDIVIDUAL CALL  
 TO: 11111111  
 MODE: SSB TELEPHONY  
 DSC: Tx/Rx 2177.0 kHz  
 WORK: Rx 1223.3 Tx 8707.0 kHz

CANCEL SEND

**ACKNOWLEDGE RECEIVED**

ON 2187.5 kHz  
 FROM 000219100

LIFT HANDSET TO ACKNOWLEDGE

CANCEL SILENCE CONNECT VIEW



Starts transmission of the call



Displays the contents of the acknowledgement  
 Sets mode and frequency as indicated in the acknowledgement

If no acknowledgement is received within 5 minutes, the equipment returns to the previous telephony display and starts scanning if selected.



## 4.8 Sending an area call

This call type is used for announcing a vital safety or urgency message.

For further information on area call see chapter "Geographic Area Computation".

**Menu**

Press the Menu button and  
select 1. DSC CALL  
select 3. AREA

ENTER AREA CENTER

TYPE: AREA CALL

LAT: N56°34

LON: E012°34

RAD: 500

CANCEL S ◀ OK

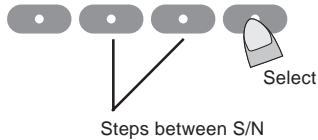

ENTER AREA CENTER

TYPE: AREA CALL

LAT: N56°34

LON: E012°34

RAD: 500

CANCEL W OK

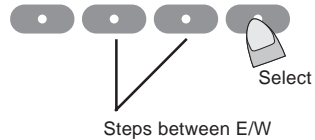

ENTER AREA RADIUS

TYPE: AREA CALL

LAT: N56°34

LON: E012°34

RAD: 500\_

CANCEL ◀ OK

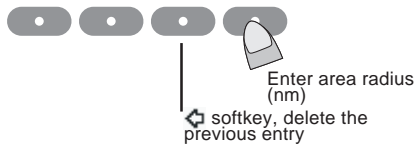

SELECT CATEGORY

TYPE: AREA CALL

AREA: N56°34 E012°34,500 nm

CAT: SAFETY

CANCEL CATEGORY OK

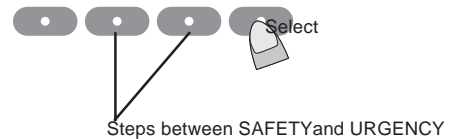

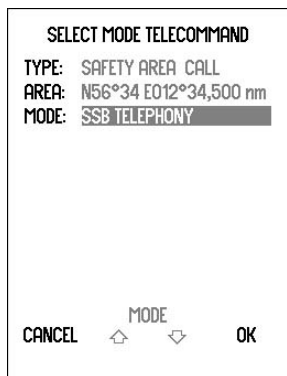

Use softkey and to select mode

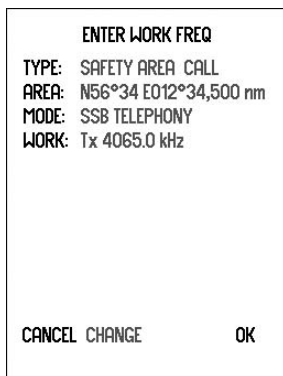

Insert the TX working frequency in the call  
Selects the telephony display for change of working frequencies

The working frequency for safety calls is normally the distress and safety frequency in the same band as the DSC call, i.e. 2182 kHz on MF.

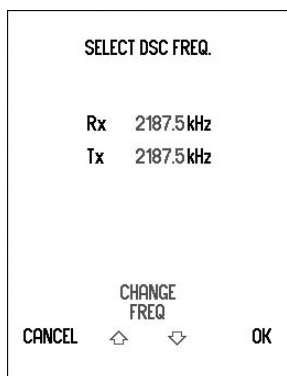

Steps between DSC frequencies  
Select the DSC frequencies



Returns to the previous display  
Starts transmission of the call

When transmission ceases the equipment is set to SSB telephony and the working frequencies indicated in the call.

Transmit the safety message as follows:

- SECURITE, spoken three times;
- ALL STATIONS, spoken three times;
- the words THIS IS;
- the NAME or other identification of own ship
- the MMSI if needed;
- the text of the safety message

Returns to the previous telephony setting, by an off-to-on hook transition.

## 4.9 Repeat a call

**Menu**

Press the Menu button and select 2. DSC LOG

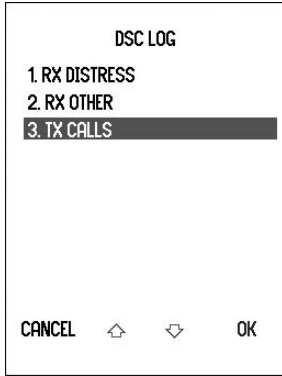

Select TX call log  
Selects non-distress RX call log  
Selects Distress RX call log  
Returns to previous display

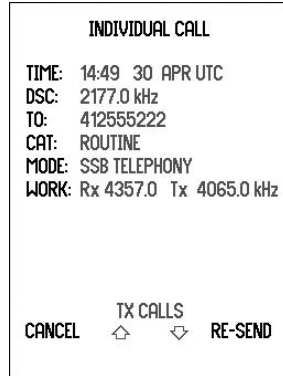

RE-SEND start transmission of the call

Detail

The TX calls log has capacity for storing 20 transmitted calls. The oldest call is deleted when the capacity is exceeded.

**RE-SEND** does not appear for acknowledgement calls and distress format and category calls.

## 4.10 Composed DSC calls

The equipment enables the possibility to pre-compose a DSC routine call for later use.

**Menu**

Press the Menu button and  
select 3. COMPOSED DSC CALLS

To enter a new pre-composed DSC routine message press the MODIFY soft key followed by pressing the ADD soft key. Note that you will have to scroll down to an empty message before the MODIFY soft key appears.

Detail

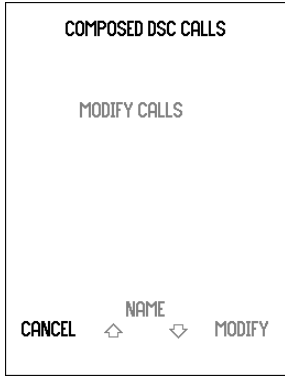

Select MODIFY

Returns to previous display

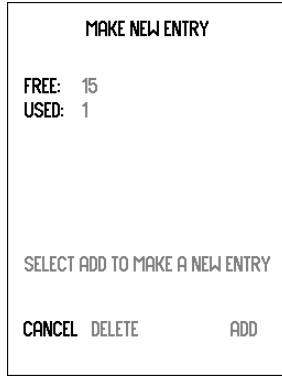

Select ADD to  
make a new entry

Returns to previous display

Select between a call to coast station, ship or group by using the Up/Down soft keys and select OK. Alternatively use quick select by pressing either the 1, 2 or 3 button.

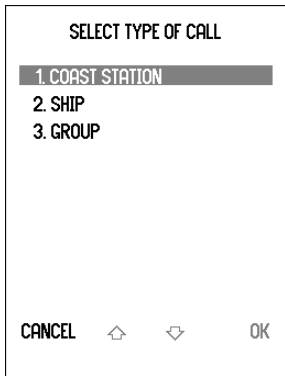

Select OK

Steps up or down  
between types

Returns to  
previous display

The user is now asked for MMSI, Mode, frequency. When all the information is entered the user is asked to enter a name.

**ENTER WORK FREQ**

TYPE: INDIVIDUAL CALL  
 TO: 112233445  
 MODE: SSB TELEPHONY  
 WORK: Rx2182.0 Tx2182.0 kHz

CANCEL CHANGE OK

**ENTER NAME OF ENTRY**

NAME: RUTH  
 TO: 112233445  
 WORK: Rx2182.0 Tx2182.0 kHz  
 DSC: Rx2177.0 Tx2177.0 kHz

CANCEL  OK



Select OK to make a new entry





Select OK

To delete an already stored DSC routine call press the MODIFY soft key followed by DELETE.

Send an already stored DSC routine call by using the Up/Down soft keys and press OK.

**COMPOSED DSC CALLS**

NAME: RUTH  
 TO: 112233445  
 WORK: Rx2182.0 Tx2182.0 kHz  
 DS : Rx2177.0 Tx2177.0 kHz

CANCEL  NAME  OK



Select OK to make a new entry

Steps up or down between composed DSC calls

## 4.11 DSC call menu

MENU								
1. DSC CALL	1. COAST STATION	1. WITH PHONE NO	MMSI	Phone no	MODE	DSC freq		
		2. WITHOUT NO	MMSI		MODE	DSC freq		
	2. SHIP		MMSI		MODE	Working freq	DSC freq	
	3. AREA	POS	CATEGORY	MODE	Working freq	DSC freq		
		RADIUS						
	4. DISTRESS	1. ALERT	MODE	Nature of distress *	POS	DSC freq		
		2. RELAY	1. COAST STATION	MMSI	Ship in distress	MODE	Nature of distress *	POS
			2. SHIP	MMSI				
	3. AREA		POS					
			RADIUS					
	5. INDIVIDUAL	MMSI	CATEGORY	MODE	FREQUENCY POSITION	DSC freq		
	6. GROUP	MMSI	MODE	Working freq	DSC freq			
	7. TEST CALL	1. SHIP TEST CALL	MMSI	DSC freq				
2. COAST STATION TEST CALL		MMSI	DSC freq					

\*) Nature of distress:

FIRE, EXPLOSION, FLOODING, COLLISION, GROUNDING, DANGER OF CAPSIZING, SINKING, DISABLED AND ADRIFT, UNDESIGNATED (default), ABANDONING SHIP, PIRACY, MAN OVERBOARD, EPIRB EMISSION (Distress Relay only)

## 4.12 Geographic Area Computation

When transmitting a geographical area call, the user is requested to enter the position of the ship ( $x, y$ ) and the radius of interest  $r$ . This information is transformed to a square with a corner point  $(\lambda, \phi)$  and the length of its sides  $\Delta\lambda$  and  $\Delta\phi$ . Finally the DSC message is transmitted over the air. See the figure below for an illustration of the relation between the user input (the white circle) and the information transmitted over the air (the grey square).

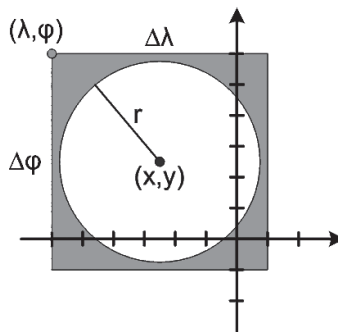

The center point is the position of the ship measured in degrees and minutes, whereas the radius of interest is given in nautical miles.

The corner point of the square and the length of its sides is given in degrees. Note that these values are rounded to degrees, and due to the requirement that the square shall include the entire circle; this will result in a slightly larger area than defined by the user input.

Also note that special handling is required when close to the poles. If the latitude of the corner point  $\lambda$  is transformed to a value greater than  $90^\circ$  then  $\lambda$  is set to  $90^\circ$  and the length of the square  $\Delta\phi$  is reduced correspondingly. If the length of the square  $\Delta\lambda$  is greater than  $90^\circ$  then  $\Delta\lambda$  is set to  $90^\circ$ .

# 5 User setup

There is a number of special setups available as shown in the setup menu. To change a setup:

**Menu** Press the Menu button and select 5. SETUP

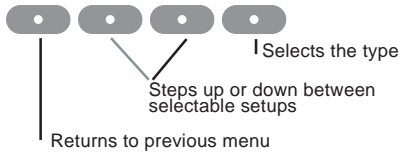
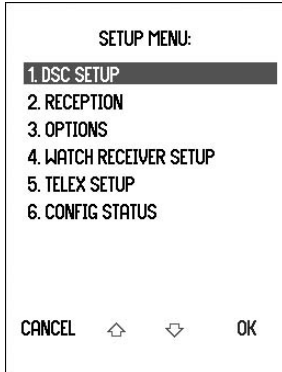

# 6 Telex operation

For the MF/HF products a Telex option is available. The Telex option is enabled by entering of a pin-code (key) into the MF/HF transceiver. This pin code is uniquely matched to the serial number of the MF/HF transceiver, i.e. one specific pin code will enable the telex option in one specific MF/HF transceiver only.

Once in possession of the required pin code the telex option is enabled from the menu point Telex setup in the Setup menu. The 10-digit pin code is entered from the transceiver keypad. When the pin code has been entered and the telex option enabled, the telex feature remains permanently available for selection.

Detail

## 6.1 Telex setup

Menu

Press the Menu button and  
select 5. SETUP  
select 5. TELEX SETUP



Returns to previous menu

Press CHANGE to enable



## 6.2 Simple telex operation

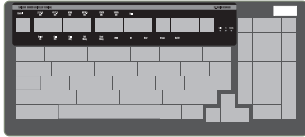
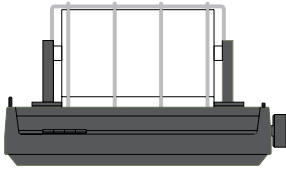

### 6.2.1 Keyboard

#### Keyboard Indicator Lamps

- 'Standby'      Steady light indicates that the terminal is ready.  
Flashing light indicates that the printer is off or out-of-paper or the modem is busy/inhibited. Telex mode must be selected in the frequency display of the CU.
- 'Tx'              Steady light indicates that a radiotelex transmission is in progress.  
Steady light in ARQ communication indicates tx mode.  
Flashing indicates phasing/ rephasing ('Called' lamp flashes as well) or repetitions.
- 'Called'         Steady light indicates that a radiotelex call has been detected and reception is in progress.  
Steady light in ARQ communication indicates rx mode.  
Flashing indicates rephasing ('Tx' diode flashes as well).

#### Keyboard Function Keys

- Select CH (F1):      Sets the frequencies of the transceiver in accordance with the selection of ITU coast station or ITU intership channel and the entry of ITU channel number.
- Call FEC (F2):        Initiates a FEC transmission. Responds to the printer with a choice of broadcast or selective FEC. Choosing selective FEC requires entry of call code, before the transmission begins.
- Call ARQ (F3):        Initiates an ARQ call. Responds by printing 'ARQ call code?', expecting the call code of the station to be called to be typed. Upon carriage return (↵ Enter), the ARQ transmission begins.
- Edit Mesg (F4):      Edits a message to be transmitted later.

- Send Mesg (F5): Transmits (prints in Standby) the edited message.
- WRU (F6): During ARQ communication only: Requests the other station to transmit its answer-back code.
- DE (F7): Transmits own answer-back code, see the configuration printed when entering telex mode.
- Over (F8): Changes the direction of an ARQ connection.
- Break (F9): Terminates a connection. Responds by printing 'Breaking connection'. If pressed during transmission of an edited message this is terminated. Press once more to terminate the connection.
- On/Off (F10): Switches the GMDSS telex On/Off. The 'Standby' keyboard indicator lamps gives out steady light when the switch on process is finished. Call codes, MMSI number and answer back code are printed. Telex will automatically be turned on, when entering telex mode on the control unit.  
If F10 is pressed while in a connection, the key press will have same effect as Break (F9).  
  
The following distress frequencies only takes effect when not in a connection.
  - 2174.5 kHz (Ctrl+F1): Selects the distress frequency 2174.5 kHz.
  - 4177.5 kHz (Ctrl+F2): Selects the distress frequency 4177.5 kHz.
  - 6268 kHz (Ctrl+F3): Selects the distress frequency 6268.0 kHz.
  - 8376.5 kHz (Ctrl+F4): Selects the distress frequency 8376.5 kHz.
  - 12520 kHz (Ctrl+F5): Selects the distress frequency 12520.0 kHz.
  - 16695 kHz (Ctrl+F6): Selects the distress frequency 16695.0 kHz.
- Bell (Ctrl+F7) Transmits Bell character.

### 6.2.2 Switching On

Switch on the printer (The 'Select' printer indicator must be on). Select telex mode in the Frequency Display of the control unit, then telex will be started after 2 seconds. The delay allows the user to toggle through the modes without printing the configuration as described below.

The 'Standby' keyboard indicator lamp shines steady light when connection to the telex modem is established and the following text appears on the printer (example):

```
5-digit call code: 12345
MMSI number:      123456789
Abbreviated ID:   123456789 abcd x
```

### 6.2.3 Switching Off

When pressing the F10 key, radiotelex will be turned off and the standby lamp will turn off. If the user is in a connection or sending a message, the key press will have same effect as Break (F9).

If radiotelex is switched off by pressing the mode button on the control unit, any current connection will be interrupted.

## 6.2.4 Channel selection

Press F1. The printer responds by printing:

'ITU Coast station / interShip channel (C/S)?:

After pressing 'C' or 'S' as desired the channel number is requested and must be typed in. The validity of the channel number is checked.

If the channel number does not exist this is indicated. If the channel number exists the corresponding frequency pair is printed and the transceiver is set accordingly.

The radiotelex distress and safety frequencies may be selected by simultaneously pressing 'Ctrl' and the appropriate function key F1 to F6.

## 6.2.5 Transmitting a message

Before calling, it must be ensured that the transmission will not interfere with transmissions already in progress. Switch the loudspeaker on and listen on the selected channel.

Press *Call FEC* or *Call ARQ* as desired and enter the call code of the station to be called. For communication between two stations the ARQ mode should be used. FEC is used to broadcast a message.

Before any message can be sent, wait until the connection has been established, or in the case of FEC until the opening phase sequence has been transmitted. When the system is ready for message transmission a ">" is printed and the Tx keyboard indicator shines steady light.

After a successful ARQ connection has been established, answerback codes may be exchanged by pressing the WRU and DE keys. A message may now be transmitted by pressing carriage return (→Enter) followed by the message to be transmitted, either typed in directly from the keyboard, or recalled from the text memory by pressing the *Send Message* key. Communication with coast stations must be in accordance with the procedures specified by the particular coast station. Where the appropriate facilities are provided by the coast station, traffic may be exchanged with the land telex network. Having completed the transmission, an exchange of answer-back codes should take place. The radio connection is terminated by pressing the *Break* key.

## 6.2.6 Editing a message

A text memory is used for storing a message for later transmission. The message can be transmitted one or more times. The message is printed out when the *Send Message* key is pressed in standby mode.

A message can be entered into the text memory after pressing the *Edit Message* key in standby mode. Any previous contents of the text memory are printed out then it may be supplemented, corrected or deleted. The maximum size of a message is 4000 characters.

Editing keys:

<i>Edit Mesg(F4)</i>	Selects edit-mode and prints the contents of the text memory.
<i>Backspace</i>	Deletes the last character keyed in if it has not been printed.
<i>Insert</i>	followed by line number, selects a line. The contents of the line, if any, are printed.

Text may be added or deleted.

*Delete* Deletes the last word of the line Deletes message (after confirmation) if pressed after *Edit (F4)*.

Line numbers (10, 20, etc.) are added automatically when typing the message.

## 6.2.7 Receiving a message

Reception is possible whenever the terminal is on, indicated by steady light in the 'Standby' keyboard indicator. The radio must be set to telex mode and to the desired working channel. When a call is detected the 'Called' keyboard indicator lamp is turned on. In case of paper-out during reception the connection is terminated.

## 6.2.8 Example of FEC Transmission

Assuming the GMDSS telex terminal is in Standby and the radio is set up to telex mode and to the desired frequencies following a DSC Distress alert call, proceed as follows:

Press *Call FEC*. The printer responds by printing:  
Broadcast FEC or Selective FEC (B/S)?

Press the 'B' key. The printer responds by printing:  
Broadcast FEC call 2007-06-20 12:30:23, Tx 2174.5 kHz.

The transmission starts, the 'Tx' keyboard indicator starts flashing and the control unit display indicates that the transmitter is delivering RF output to the aerial. When the phasing sequence (including carriage return, line feed, letter shift) has been transmitted the 'Tx' lamp shines steady light and the printer responds by printing:

>

The communication to follow must be in accordance with the procedures specified for distress traffic and contain:

- the distress signal 'Mayday';
- the words 'this is';
- the 9-digit identity and call sign or other identification of the ship,
- the ship's position if not included in the DSC distress alert;
- the nature of distress;
- any other information which may facilitate the rescue.

The connection is terminated by pressing the Break key, then Standby keyboard indicator lamp starts blinking. After a few seconds transmission stops, the Standby keyboard indicator lamp shines steady and the terminal is ready to receive.

## 6.2.9 Example of ARQ Transmission to a Coast Station

When the GMDSS telex terminal is on, indicated by the 'Standby' keyboard indicator lamp, and the radio is configured to the desired working channel (and, if requested by the coast station, free signal can be heard in the speaker), press the *Call ARQ* key.

The printer responds by printing:

Enter ARQ call code:

Type in the call code, e.g.: 0832

If ok, press carriage return (<- Enter), (otherwise press *Call ARQ* again).

The printer responds by printing:

ARQ 0832 call, 2007-06-20 12:45:10,

The transmission starts, the 'Tx' keyboard indicator lamp starts flashing and the control unit display indicates that the transmitter is delivering RF output to the aerial. When successful connection has been established the 'Tx' keyboard indicator lamp shines steady light and the printer responds by printing:

>

The exchange of answer-backs is initiated by the coast station. The answer-back code of the called station is printed:

0832 AUTOTX DK

X

followed by a go ahead indication and a traffic direction change:

GA+?

If direct connection with a land telex subscriber is wanted, type:

dirtlx54321+

where 54321 is the telex number of the subscriber. The coast station responds with:

MOM

Dialling follows automatically, and simultaneously the number selected is sent to the ship:

54321

When the connection is ready, the time, answer-back, "via Lyngby Radio" and "MSG+?" is sent:

07-06-20 12:46

54321 ZYXW VIA LYNGBY RADIO

MSG+?

Send own answer-back by pressing the *DE* key:

123456789 abcd x

The message is now transmitted by pressing carriage return (↵) followed by the message to be transmitted, either typed in directly from the keyboard, or recalled from the text memory by pressing the MESSAGE key:

this message is typed in directly from the keyboard or recalled from the text memory.

Having completed the transmission, the answer-back code of the subscriber is requested by pressing the WRU key:

X  
54321 ZYXW

and own answer-back is sent by pressing the DE key:

123456789 abcd x

To disconnect the land line type:

kkkk

The coast station responds with:

Time: 07-06-20 12:48  
Ship: 123456789 ABCD X  
Subscr: 54321  
Duration: 1.3  
GA+?

A new land line connection may be made or the radio connection terminated by pressing the Break key. After the end-of-communication procedure the transmission stops and the 'Tx' keyboard indicator turns off.

#### **Symbols printed:**

- [ : Cyrillic symbol start, latin symbol stop
- ] : Latin symbol start, cyrillic symbol stop
- ✠ : Maltese cross (WRU)
- ! : Printing and sending from editor
- +? : Over. When making an Over the text on sender printer can differ from receiver printer
- ★ : Symbol error

## 6.3 Telex via data terminal

### 6.3.1 Radio Telex software

Basically the system consists of the Radiotelex software and a Radiotelex module (modem). The Radiotelex software runs on a computer of one of the following types:

- a marine PC,
- a communication computer, or
- an ordinary PC not using Windows. (Running DOS)

Data terminal TT-3606E offers advanced but simple to use radio telex communication.

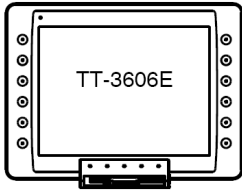

The TT-3606E Telex terminal offers the following features:

- Composing and transmitting online messaging
- Transmitting pre-composed messages
- Scanning for incoming telex calls (scan specific channels on specific hours)
- Logging incoming Telex messages

Complete operators manual are included in the Radio telex Software package.

## 7 Data call

Data service via MF/HF is offered by various service providers utilizing their individual application hardware and software external to the MF/HF equipment.

To operate data service the MF/HF radio must have been prior configured to allow operator selection of Remote mode of operation.

This paragraph refers only to the operational part on the radio side. For details on the operation of the data service application equipment refer to the suppliers documentation.

To prepare the MF/HF for a data call select Remote mode of operation by toggling the Mode button until "Remote" is indicated in the display. Data calls may now be setup from the external data equipment.

Having finalized the data call(s) revert to preferred mode of operation by toggling the Mode button until required mode of operation is indicated in the display.

Note: Shall be enabled in the setup menu before use !!!

# 8 Scanning



To start scanning the “4” button is pressed.

The last used scanning type is selected and squelch is set to on when scanning is activated. Speaker is set to on if the scanning type is Telephony Watch, Multi Watch or Dual Watch. Scanning is stopped by pressing softkey EDIT or by lifting the handset off hook. For Multi Watch or Telephony Watch scanning stops on the presently scanned telephony channel, for Dual Watch and DSC Watch the previous telephony setting is restored. Scanning resumes when the handset is placed on hook again.

Detail

## Scanning types

### Telephony watch:

Up to 10 telephony channels.

Scanning rate is approx. one channel per 2 sec.

### Multi watch:

A single DSC frequency (normally 2177 kHz) and up to 10 telephony channels.

Scanning rate is approx. one channel per 2 s. The DSC frequency is monitored briefly at each telephony channel shift.

### Dual watch:

A single DSC frequency (normally 2177 kHz) and the current telephony frequency.

The DSC frequency is monitored briefly at approx. each 2 s.

### DSC watch:

Up to 6 DSC frequencies.

Scanning rate is approx. six channels per 2 sec.

Use EDITsoftkey - to edit scanning frequency

Use  /  softkey - switch to next /previous scanning type

Use CANCELsoftkey - returns to previous telephony setting



## 9 Watch keeping receiver

For the MF/HF products a watch keeping option is available. The watch keeping option is enabled by entering of a pin-code (key) into the MF/HF transceiver. This pin code is uniquely matched to the serial number of the MF/HF transceiver, i.e. one specific pin code will enable the watch keeping option in one specific MF/HF transceiver only.

Once in possession of the required pin code the watch keeping option is enabled from the menu point Watch receiver setup in the Setup menu. The 10-digit pin code is entered from the transceiver keypad.

When the pin code has been entered and the watch keeping option enabled, the watch keeping feature remains permanently available for selection.

### 9.1 Watch receiver setup

#### Menu

Press the Menu button and  
select 5. SETUP  
select 4. WATCH RECEIVER SETUP

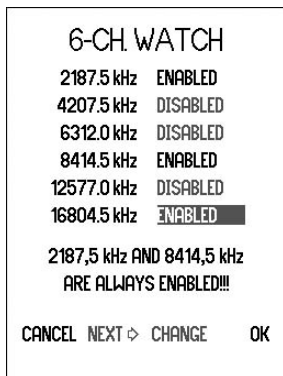

Press CHANGE to disable / enable  
Returns to previous display

Note that at least three frequencies shall be enabled.

# 10 Menu tree

Detail

MENU					
1. DSC CALL	1. COAST STATION	1. WITH PHONE NO	MMSI	Phone no	MODE
		2. WITHOUT NO	MMSI		MODE
	2. SHIP		MMSI		MODE
	3. AREA	POS	CATEGORY	MODE	Working freq
		RADIUS			freq
	4. DISTRESS	1. ALERT	MODE	Nature of distress *	POS
		2. RELAY	1. COAST STATION	MMSI	Ship in distress
			2. SHIP	MMSI	
			3. AREA	POS	
		RADIUS	MODE		
5. INDIVIDUAL	MMSI	CATEGORY	MODE	FREQUENCY POSITION	
6. GROUP	MMSI	MODE	Working freq	DSC freq	
7. TEST CALL	1. SHIP TEST CALL	MMSI	DSC freq		
	2. COAST STATION TEST CALL	MMSI	DSC freq		
2. DSC LOG	1. RX DISTRESS				
	2. RX OTHER				
	3. TX CALLS				
3. COMPOSED DSC CALLS	Select Name				
	Modify				
4. STATIONS	New	NAME	MODE	FREQ.	
	Edit	MMSI			
		CHANNEL			
5. SETUP	1. DSC SETUP	DISTRESS FREQUENCY			
		AUTO ACKNOWLEDGEMENT ON/OFF			
		AUTO POSITION TRANSMIT ON/OFF			
		AUTO CHANNEL SWITCH ON/OFF			
		TELECOMMAND MEDICAL ON/OFF			
		TELEC. SHIP AND AIRCRAFT ON/OFF			
		LAT			
		LON			
		POSITION TIME			
		DATE			
	TIME				
	2. RECEPTION	1. EARPIECE	Adj. earpiece vol. Level 0-7		
		2. RECEIVER	TREBLE CUT ON/OFF		
			SUPPRESSOR ON/OFF		
	3. CALL ALARM	Adjust call alarm 0-7			
	3. OPTIONS	Password	1. TX BANDS	New	
				Edit	
			2. CONFIGURATION	LSB mode Enable/disable	
				Remote mode Enable/disable	
				Battery Alarm Enable/disable	
		3. DSC	ATU installed YES/NO		
			Language		
			RX Test	Serial output enabled/disabled	
			TX Test	Send dot	
				Send Y	
Send B					
4. FACTORY RESET					
5. MMSI RESET					
4. WATCH RECEIVER SETUP		Enable band			
		Disable band			
5. TELEX SETUP	Enable				
	Disable				
	SLAVE DELAY (0-140ms)				
6. CONFIG STATUS					
6 INFO & TEST	1. INFORMATION	1. MMSI			
		2. VERSIONS	1. SOFTWARE		
			2. HARDWARE		
		3. ALARMS			
	4. TU SERIAL NUMBER				
	2. CHECK	1. TX PROTECTION			
		2. INTERFACE	1. SOUND & DISPLAY		
			2. ALARM PANEL		
		3. NMEA INPUT			
	3. SELFTEST	Manual			
	3. MONITOR	1. POWER	TX 2-Tone		
		2. WR AUDIO			

DSC freq			
DSC freq			
Working freq	DSC freq		
DSC freq			
DSC freq			
MODE	Nature of distress *	POS	DSC freq
DSC freq			

# 11 Installation

## 11.1 Compass safe distance

Compass safe distance in accordance with ISO/R 694 are given below in metres.

<b>Unit</b>	<b>Standard</b>	<b>Steering</b>
Control Unit	5.4°/H 1.2	18°/H 0.5
Handset	0.3	0.2
Cradle	1.1	0.7
5070 Loudspeaker	2.2	1.6







TT-98-124350-THR-B

Issue: 0735